

Statecharts

Used to model *behaviour* of Autonomous and Reactive Systems
(event driven, react to internal –timeouts– and external stimuli)

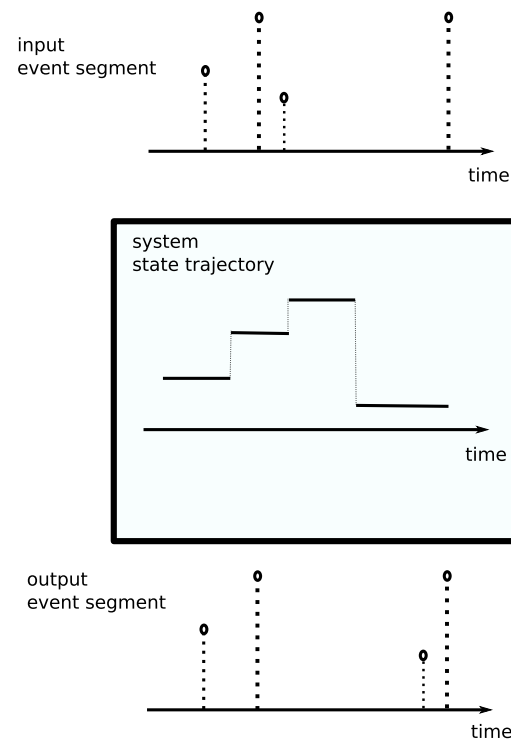

Statecharts

- Visual formalism yet formally and rigourously defined for
 1. documentation
 2. analysis (model checking as well as testing)
 3. simulation
 4. code synthesis
- Solves FSA problems (by combining with Higraphs):
 1. flat \Rightarrow hierarchy (\Rightarrow re-use)
 2. represent large number of transitions concisely
 3. represent large number of states concisely

Statecharts references

- David Harel. **Statecharts: A Visual Formalism for Complex Systems.** Science of Computer Programming. vol. 8. 1987. pp. 231 - 274.
- David Harel. **On Visual Formalisms.** Communications of the ACM. Volume 31, No. 5. 1988. pp. 514 - 530.
- David Harel and Amnon Naamad. **The STATEMATE semantics of statecharts.** ACM Transactions on Software Engineering and Methodology (TOSEM) vol. 5. Issue 4. October 1996. pp.293 - 333.
- David Harel and Hillel Kugler. **The Rhapsody Semantics of Statecharts (or, On the Executable Core of the UML).** Springer, Lecture Notes in Computer Science 3147. 2004. pp. 325 - 354.

Statecharts tools

- STATEMATE [<http://www.ilogix.com/products/magnum/index.cfm>]
- Rhapsody [http://www.ilogix.com/products/rhapsody/rhap_inc.cfm]
- Rational Rose [<http://www.rational.com>]
- Stateflow [<http://www.mathworks.com/products/stateflow/>]
- BetterState Lite
[<http://www.windriver.com/products/html/betterstate.html>]
- XJTek [<http://www.xjtek.com/products/xjcharts/>]
- Poseidon for UML [<http://www.GentleWare.com>]
- ArgoUML [<http://argouml.tigris.org/>]
- visualSTATE [<http://www.iar.com/Products/VS/>]
- SVM [<http://msdl.cs.mcgill.ca/people/xfeng/research.html>]

Statecharts =

1. Deterministic Finite State Automata (FSA, DFA)
2. Depth
3. Orthogonality
4. Broadcast
5. History
6. Time
7. syntactic sugar: entry/exit actions, ...

Deterministic Finite State Automata (FSA, DFA)

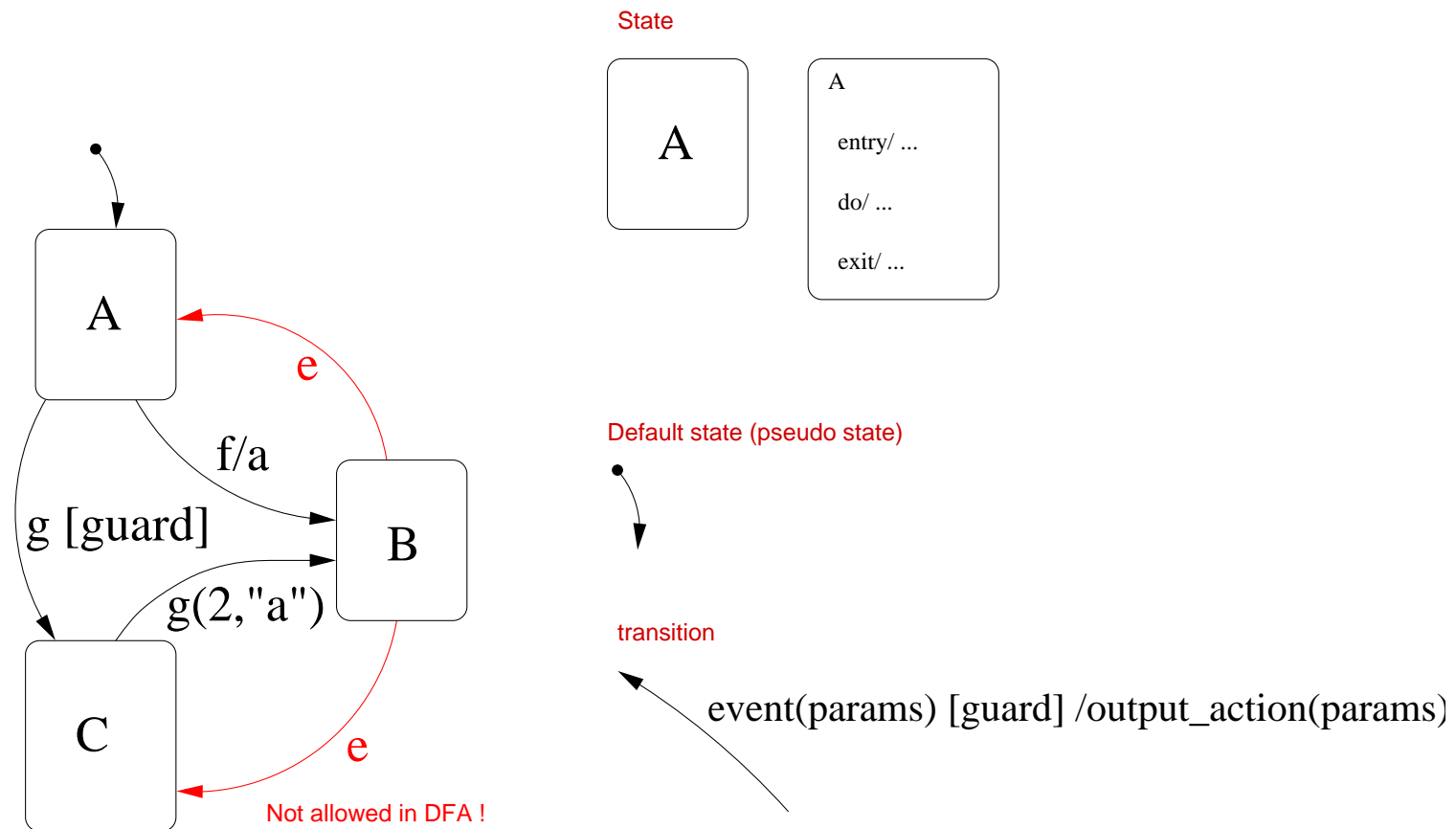

Depth (XOR)

Statechart with depth

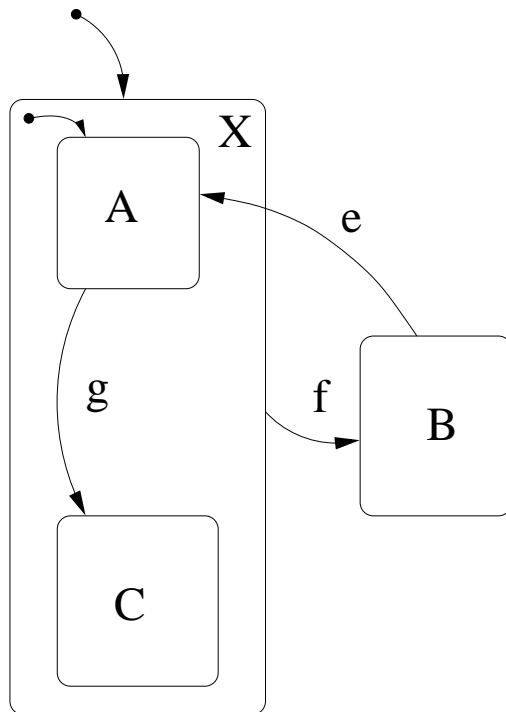

give meaning
by "flattening"



State automaton

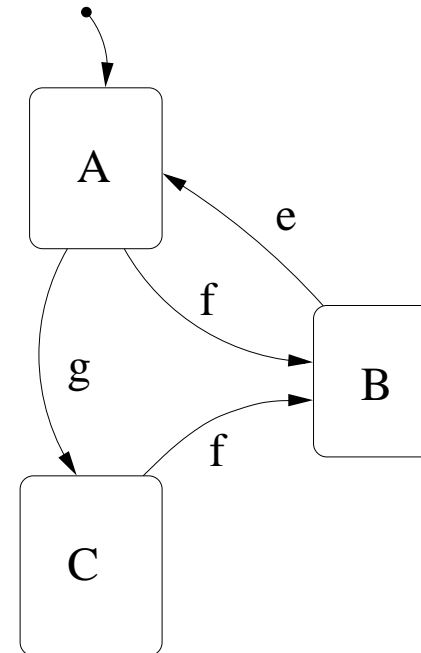

Depth and determinism

Statechart with depth

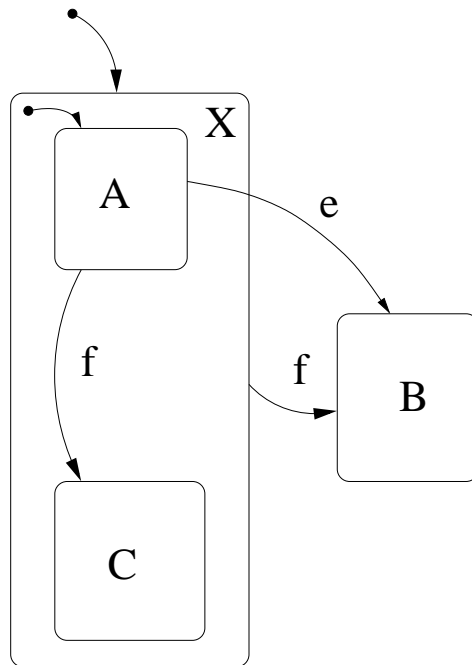

give meaning
by "flattening"



State automaton (non deterministic)

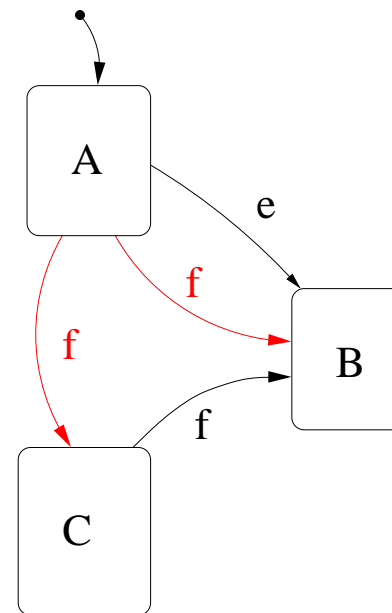

Depth and determinism

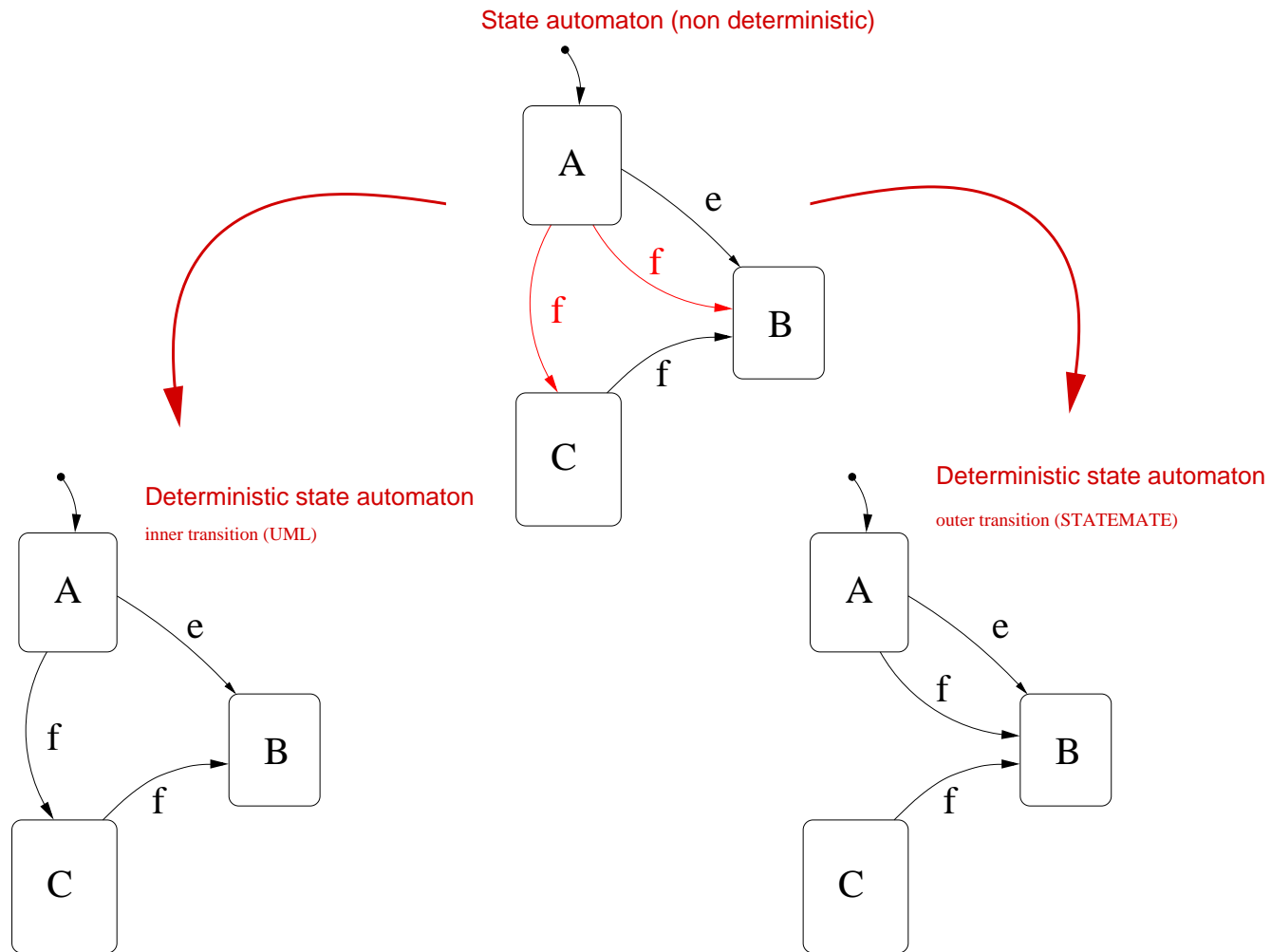

Why “inner-first” in UML Statecharts ?

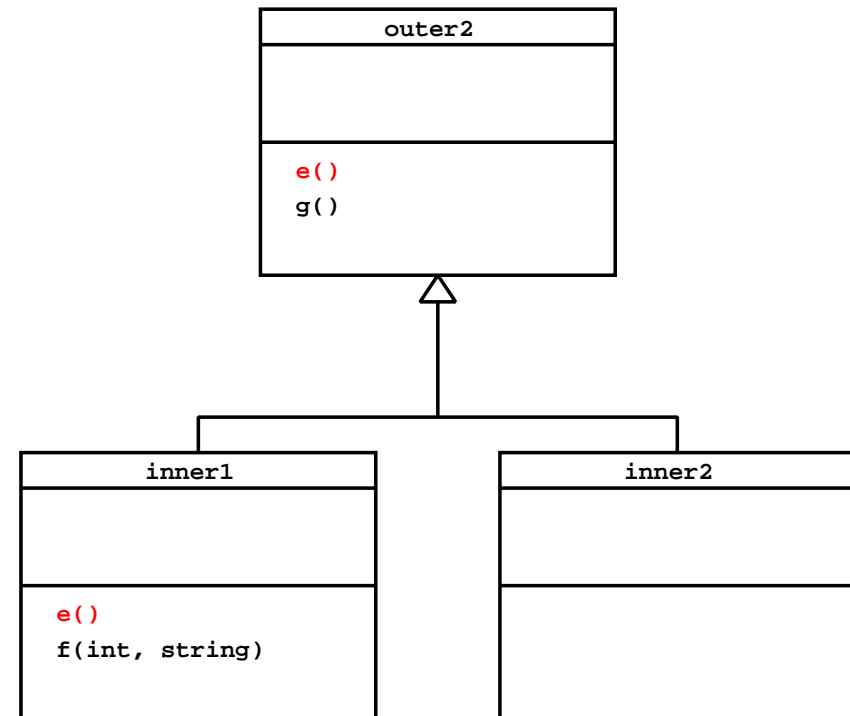
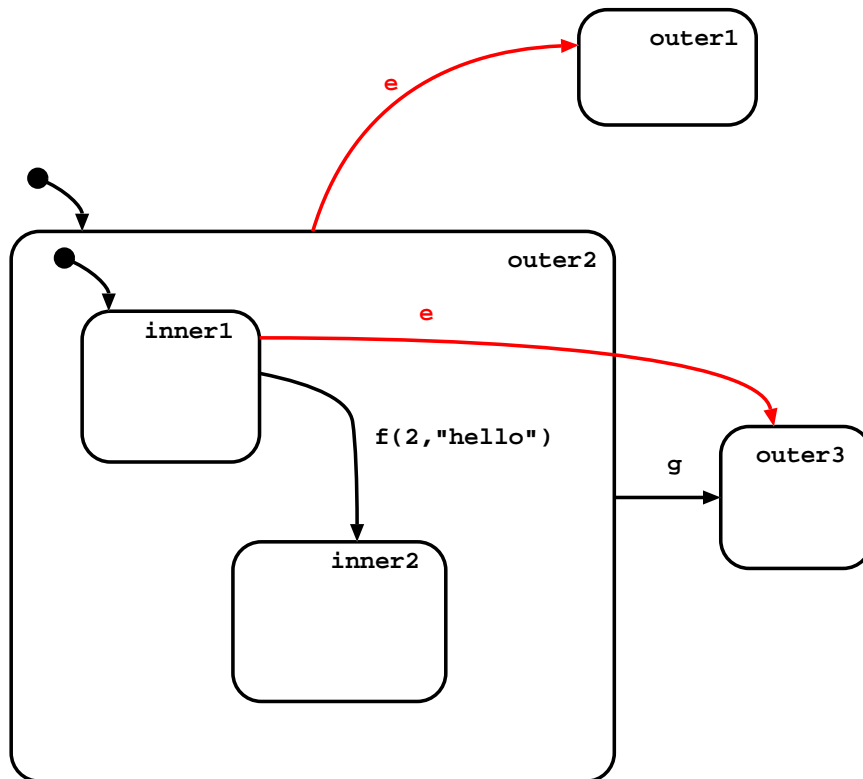

Orthogonality (AND)

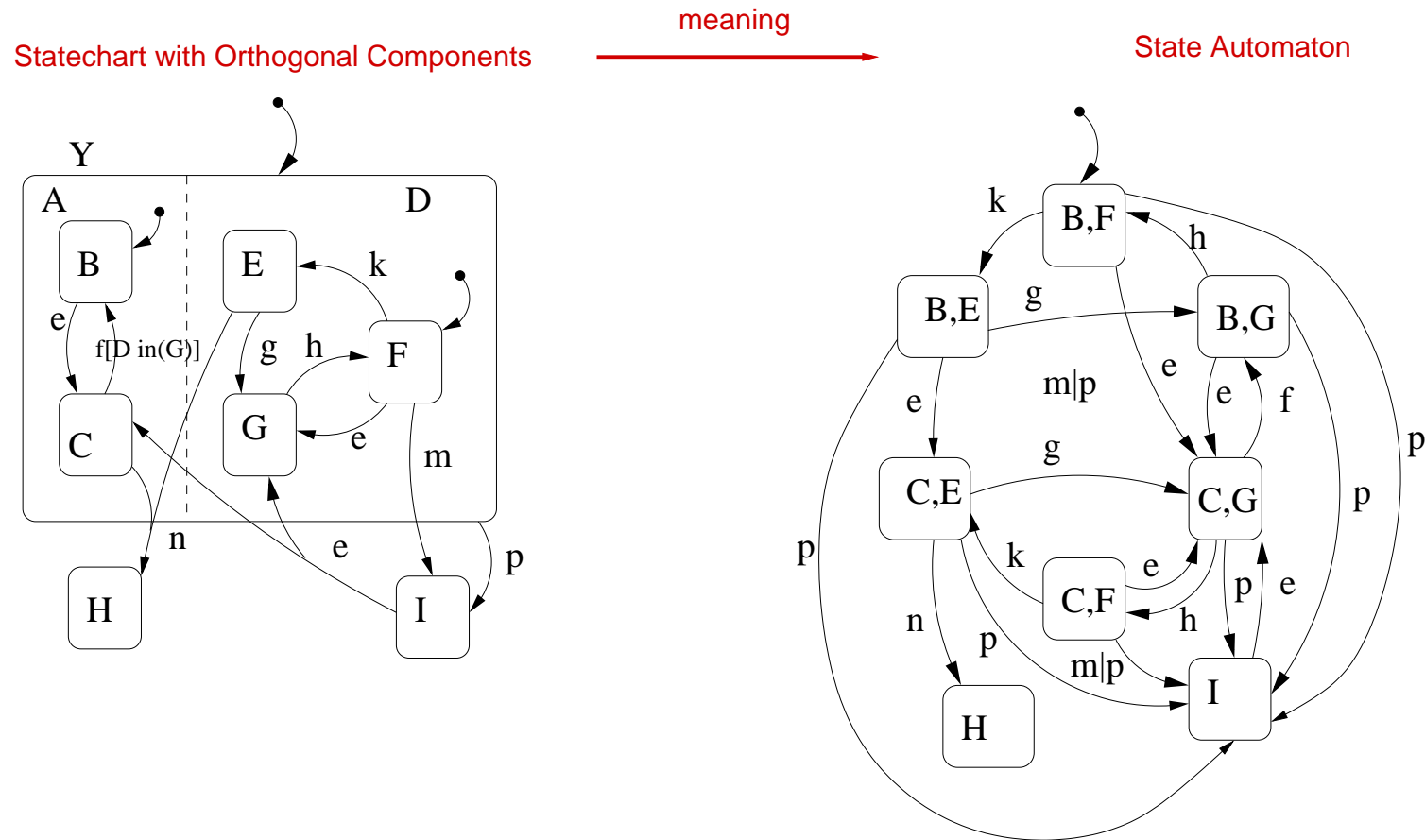

Orthogonality and synchronization

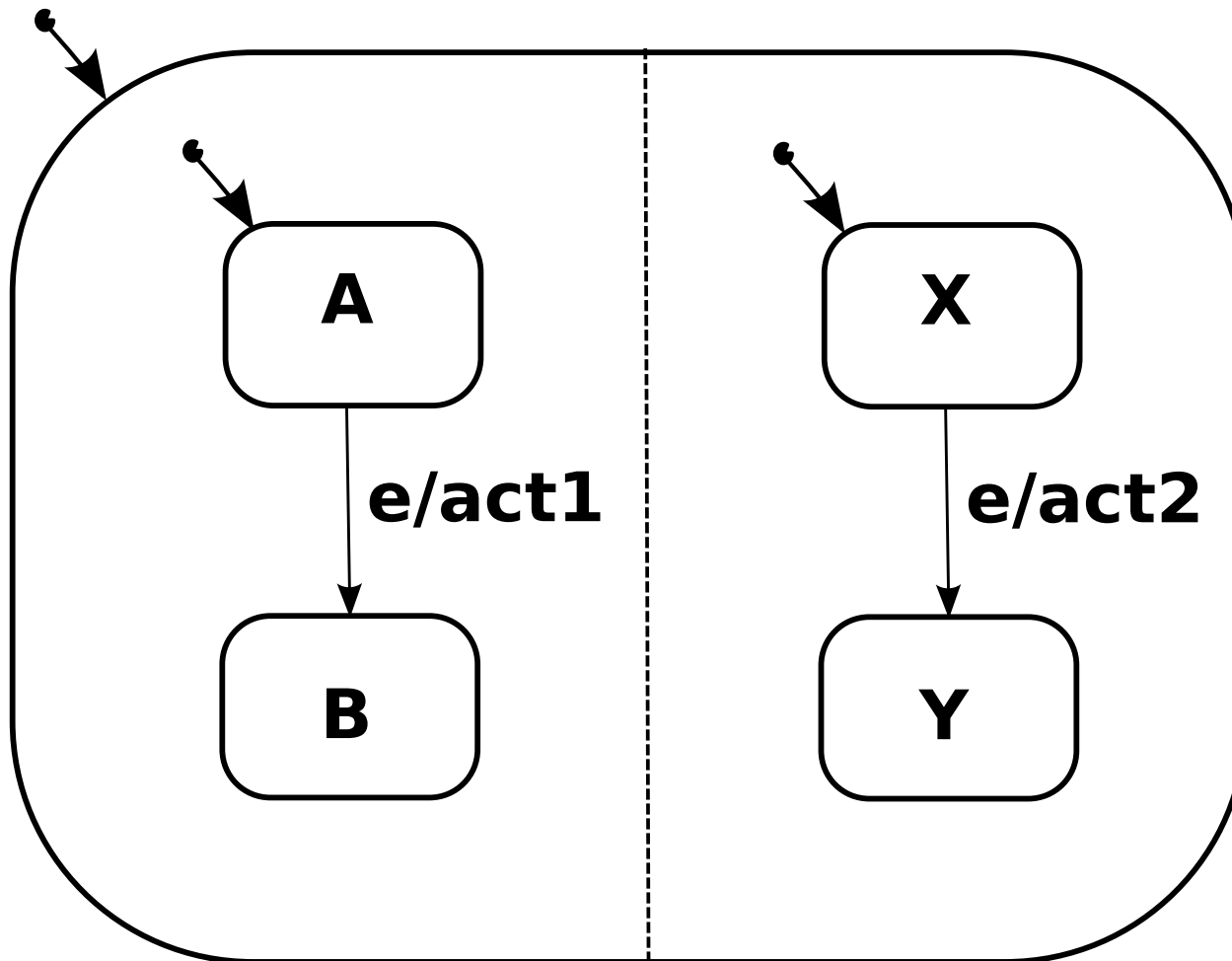

Broadcasting (output events)

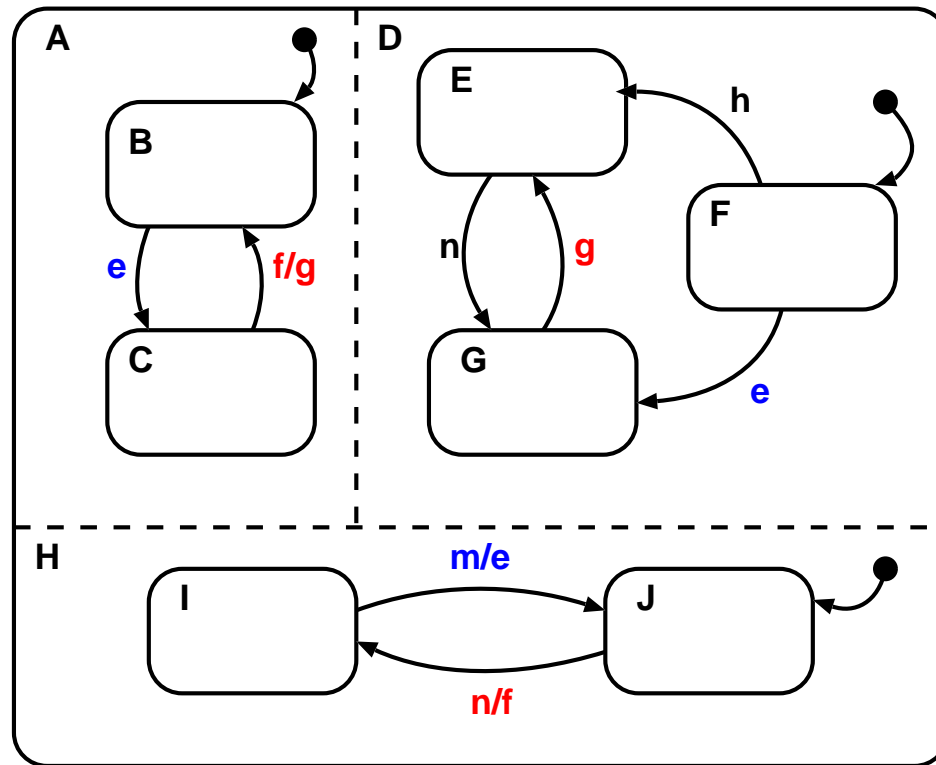

Input Segment: **nmnn**

History States

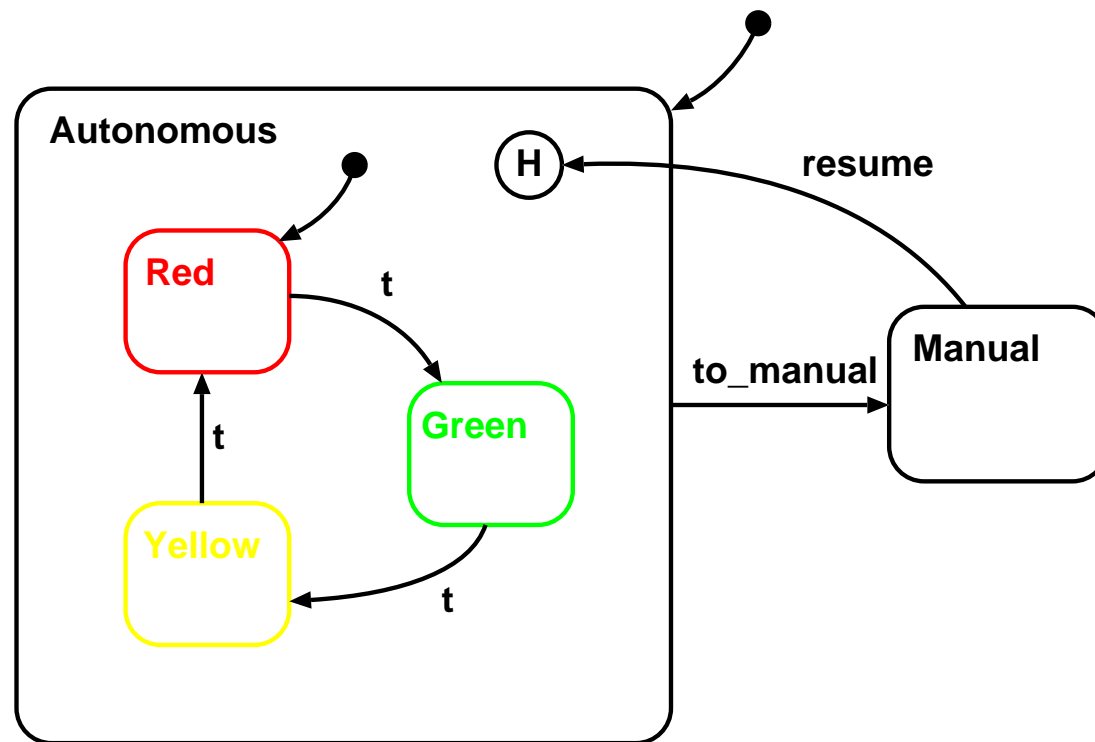

Deep History

