

Developing Reactive Systems using Statecharts

Modelling of Software-Intensive Systems

Simon Van Mierlo
University of Antwerp
Belgium
simon.vanmierlo@uantwerpen.be

Hans Vangheluwe
University of Antwerp
Belgium
hans.vangheluwe@uantwerpen.be

Axel Terfloth
itemis AG
Germany
terfloth@itemis.de

Introduction

Reactive Systems



Reactive Systems

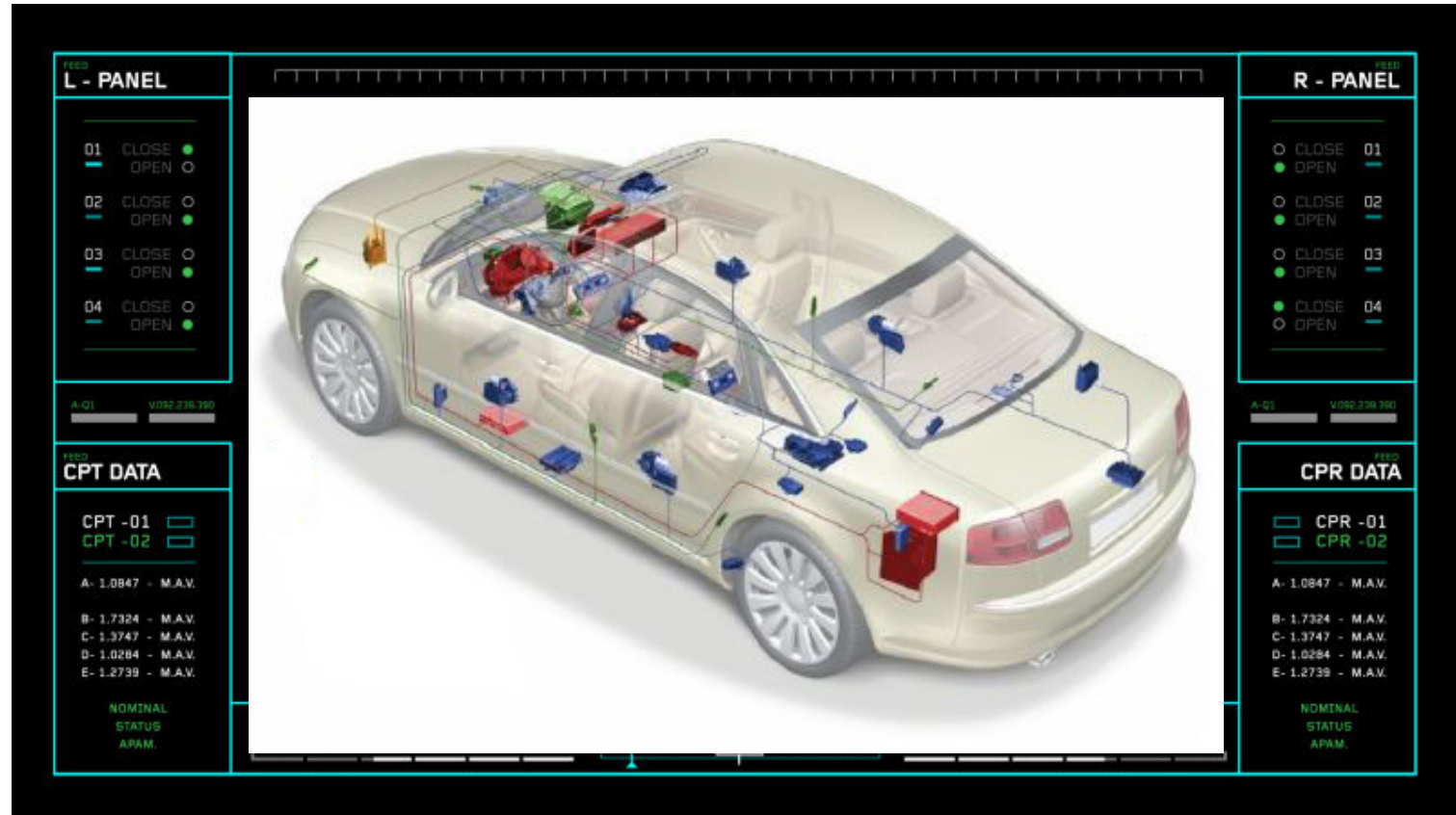

Reactive Systems



Reactive Systems



Reactive Systems



- Concurrent, behavioural

Reactive Systems



- Com
- In contrast to *transformational* systems, which take input and, eventually, produce output

Modelling Reactive Systems

Modelling Reactive Systems

- Interaction with the environment: reactive to *events*

Modelling Reactive Systems

- Interaction with the environment: reactive to *events*
- Autonomous behaviour: *timeouts* + *spontaneous* transitions

Modelling Reactive Systems

- Interaction with the environment: reactive to *events*
- Autonomous behaviour: *timeouts* + *spontaneous* transitions
- System behaviour: *modes* (hierarchical) + *concurrent* units

Modelling Reactive Systems

- Interaction with the environment: reactive to *events*
- Autonomous behaviour: *timeouts* + *spontaneous* transitions
- System behaviour: *modes* (hierarchical) + *concurrent* units
- Use programming language + threads and timeouts (OS)?

Modelling Reactive Systems

- Interaction with the environment: reactive to *events*
- Autonomous behaviour: *timeouts* + *spontaneous* transitions
- System behaviour: *modes* (hierarchical) + *concurrent* units
- Use programming language + threads and *OS*?



"Nontrivial software written with threads, semaphores, and mutexes are incomprehensible to humans"

Modelling Reactive Systems

- Interaction with the environment: reactive to *events*
 - Autonomous behaviour: *timeouts* + *spontaneous* transitions
 - System behaviour: *modes* (hierarchical) + *concurrent* units
 - Use programming language + threads and mutexes (OS)
- Programming language (and OS) is too low-level
-> most appropriate formalism: "what" vs. "how"**
- "Minimal software written with threads, semaphores, and mutexes are incomprehensible to humans"*



Discrete-Event Abstraction



Discrete-Event Abstraction



input
event segment

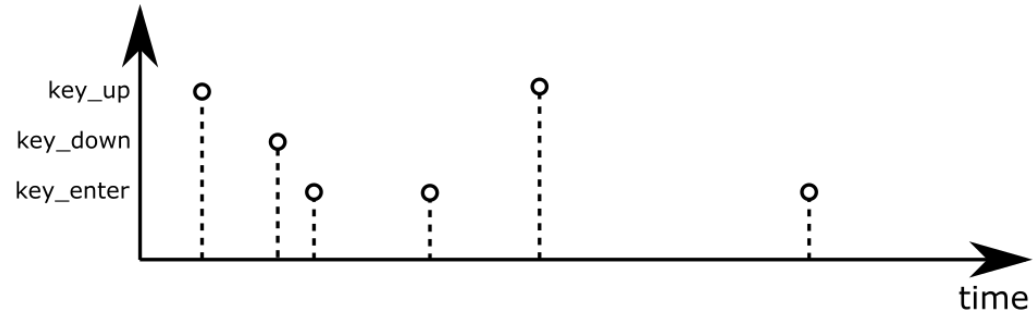

Discrete-Event Abstraction



input
event segment

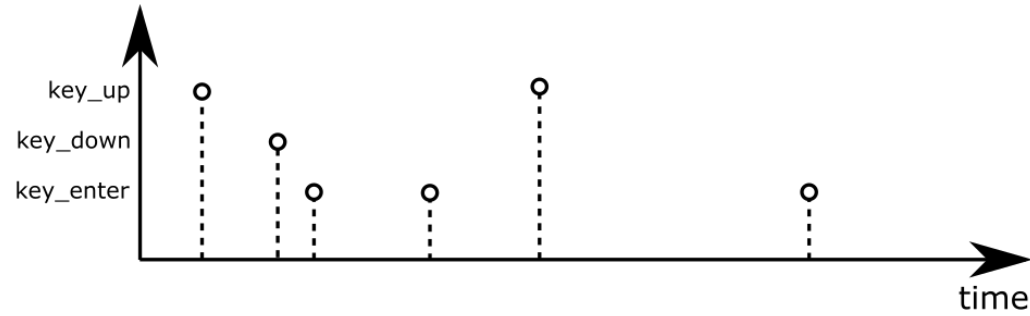

output
event segment

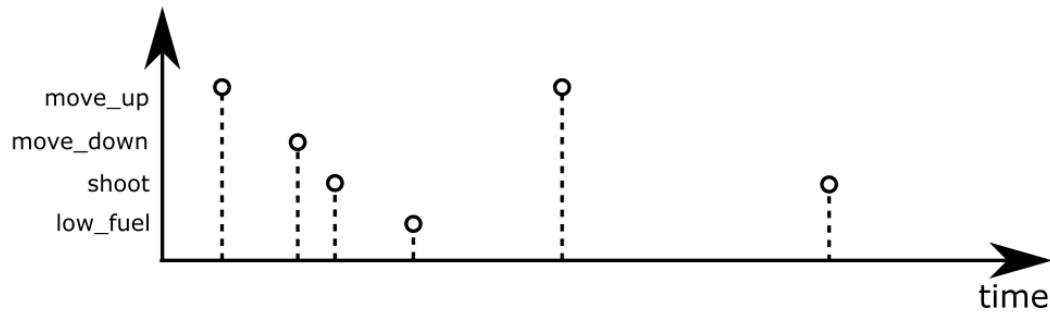

Discrete-Event Abstraction

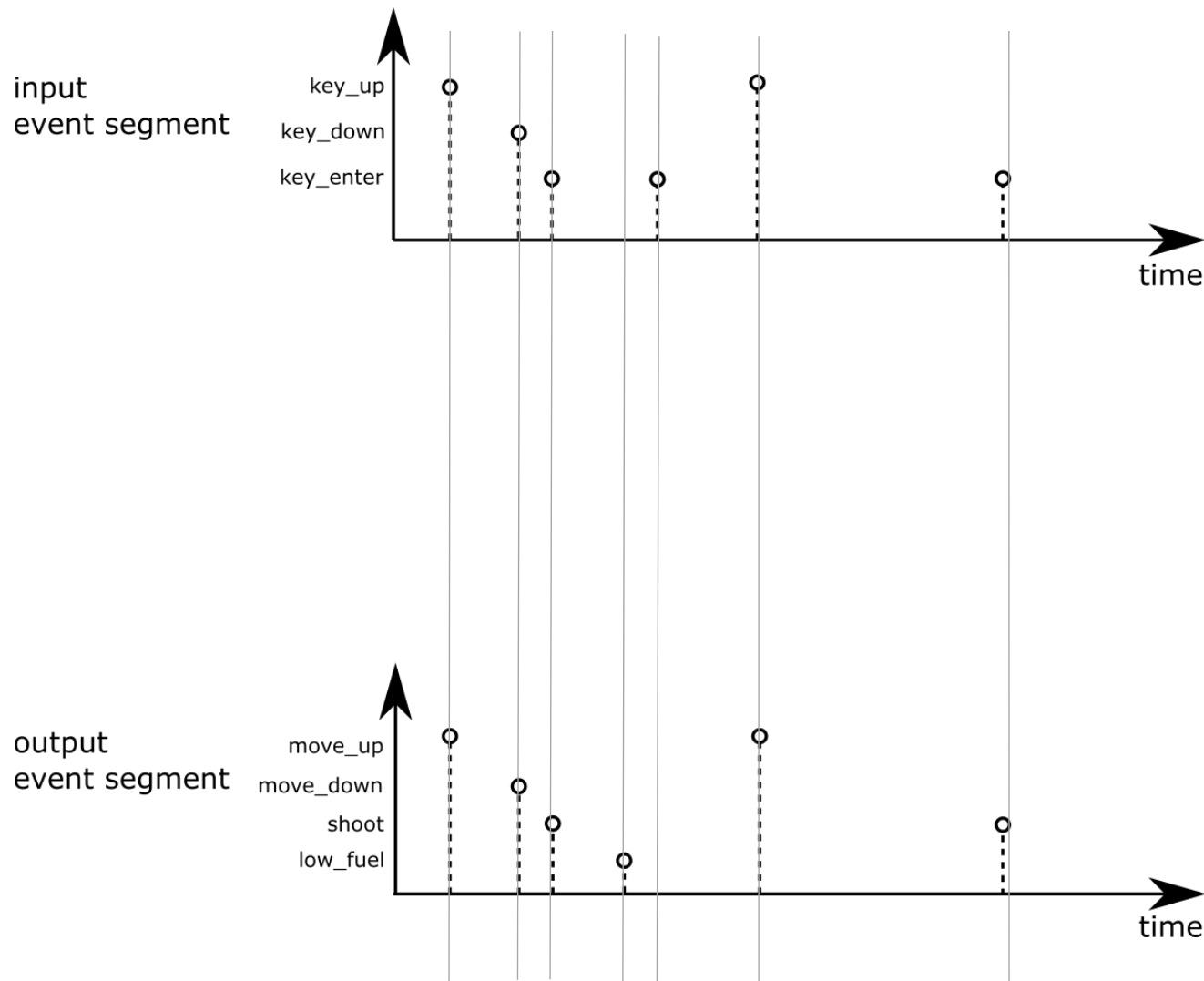

Discrete-Event Abstraction



input
event segment

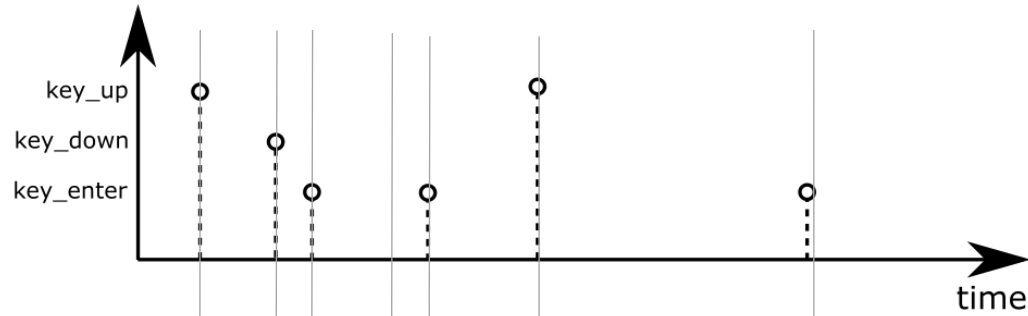

system
state trajectory

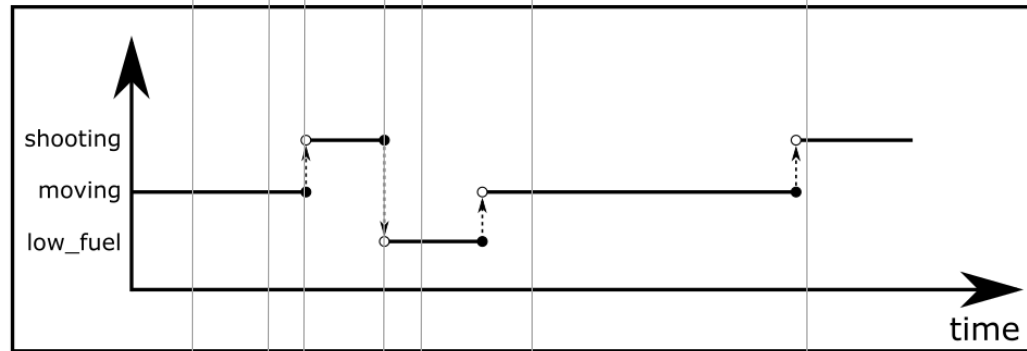

output
event segment

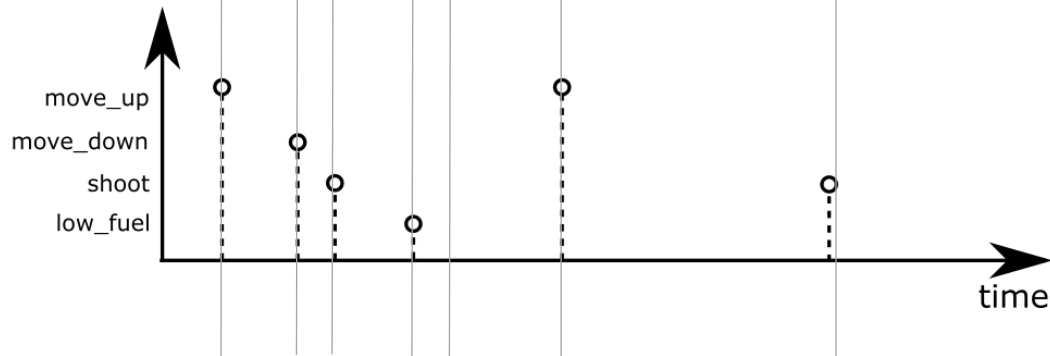

Discrete-Event Abstraction



input
event segment

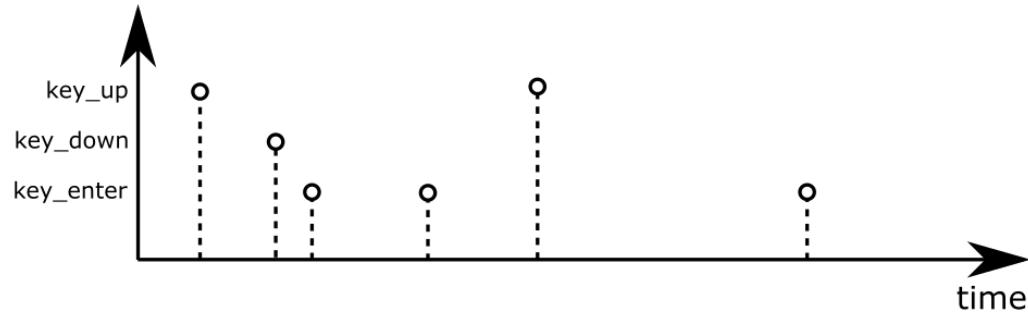

behavioural
model

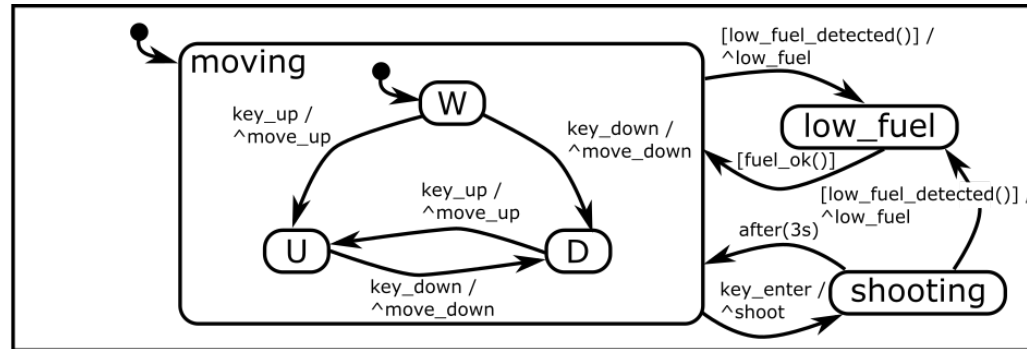

output
event segment

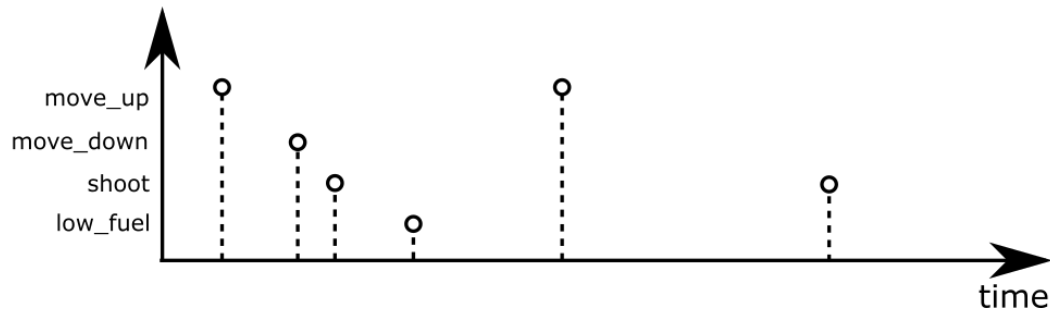

State Diagrams



VB1-2

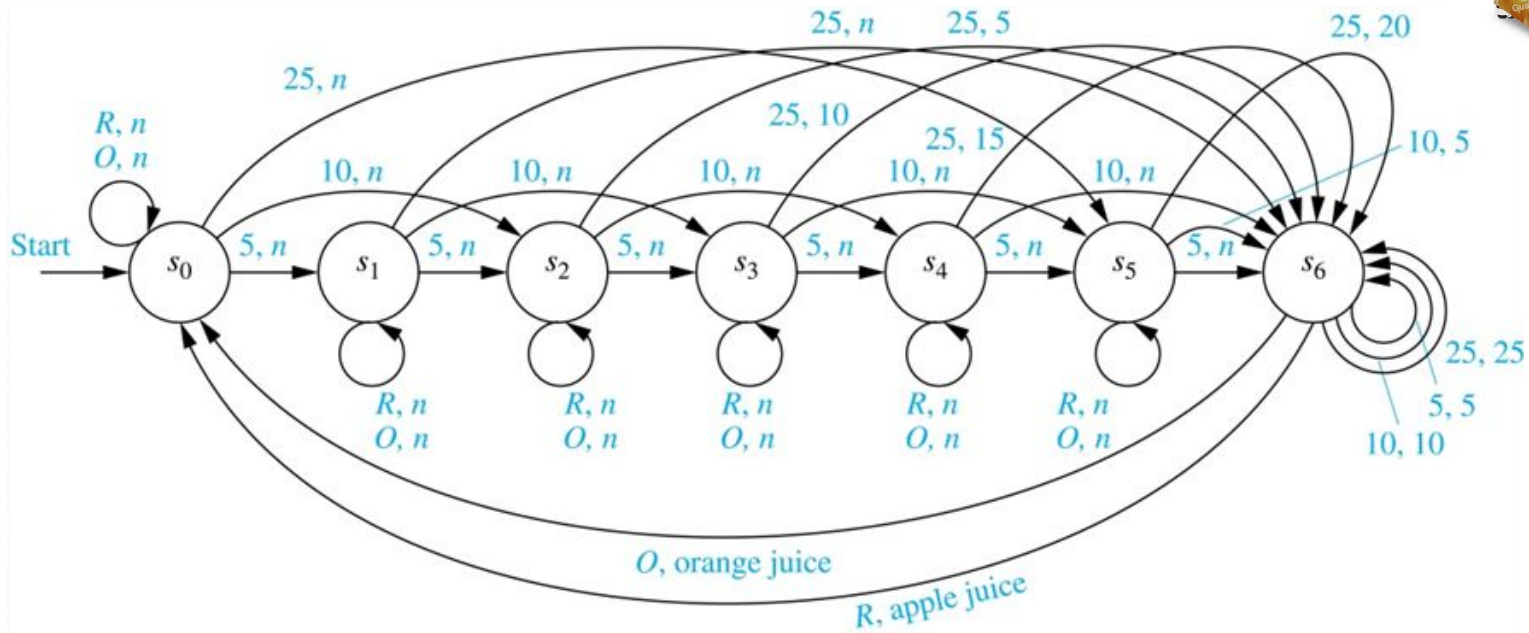

State Diagrams



VB1-2

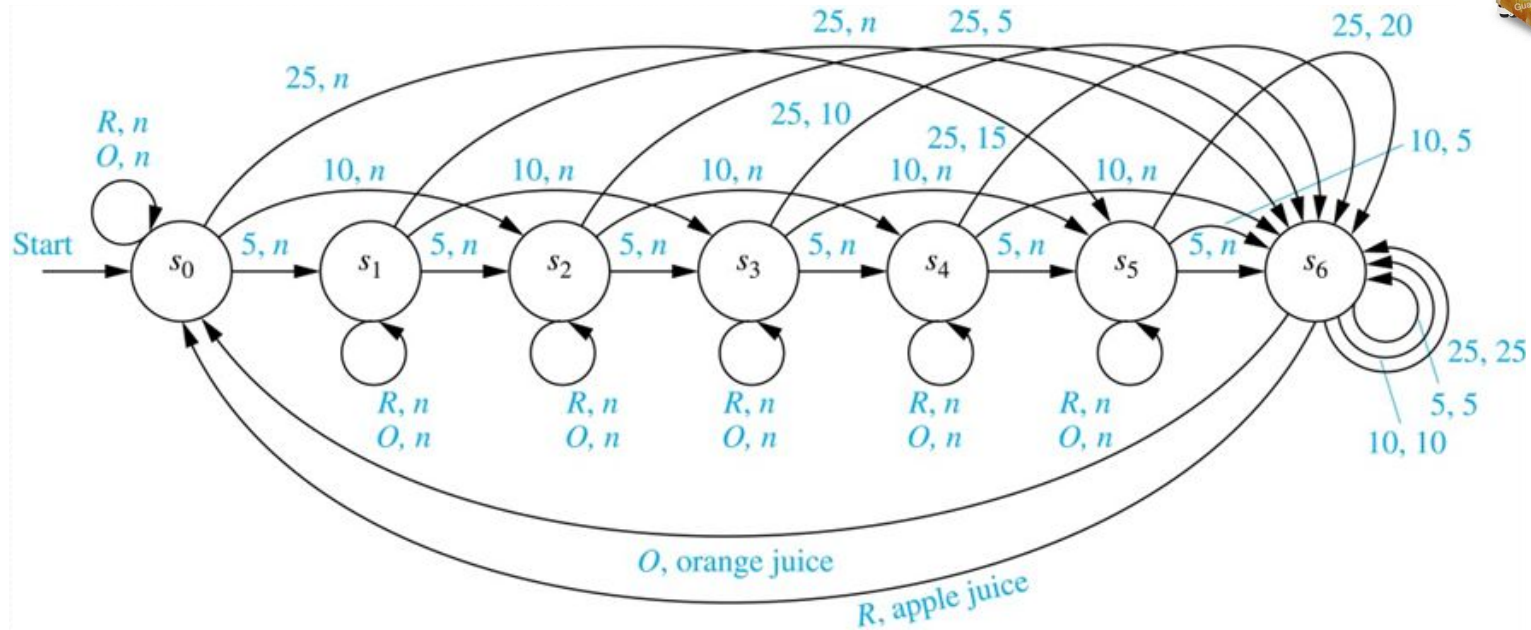

- All states are explicitly represented (unlike Petrinets, for example)

State Diagrams



VB1-2

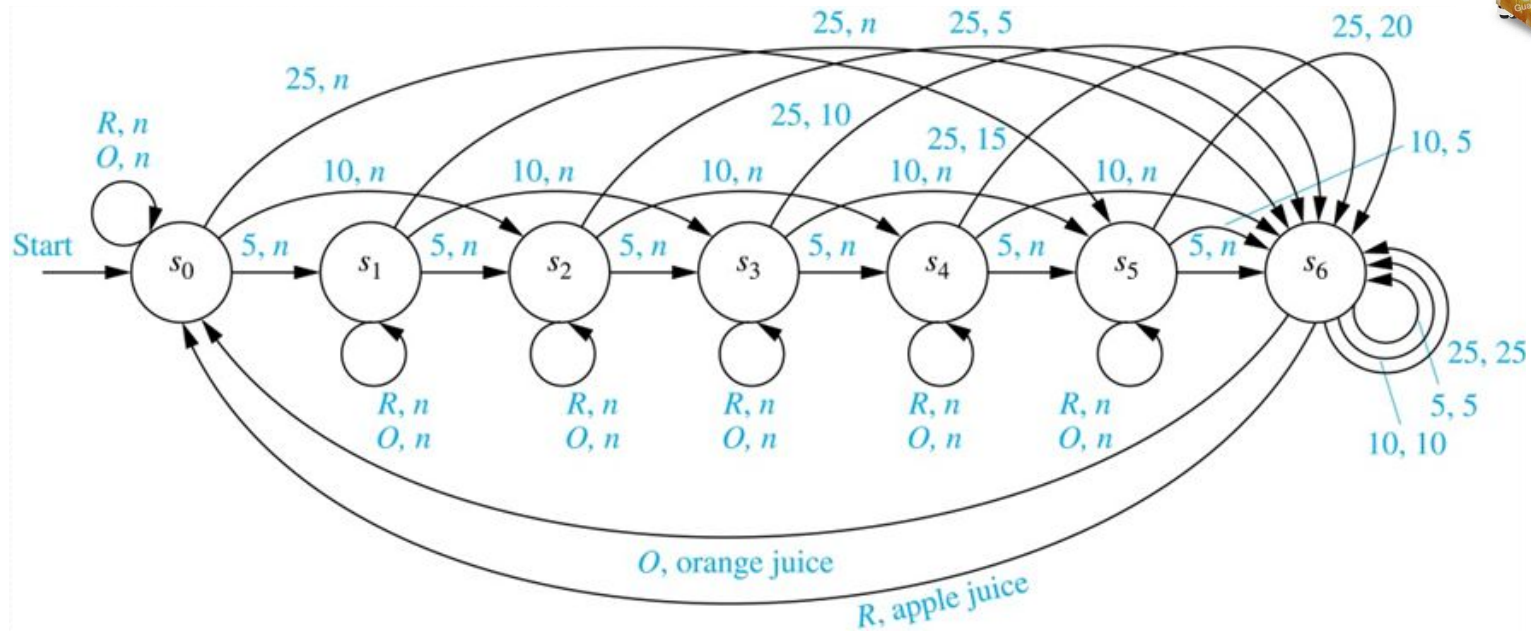

- All states are explicitly represented (unlike Petrinets, for example)
- Flat representation (no hierarchy)

State Diagrams



VB1-2

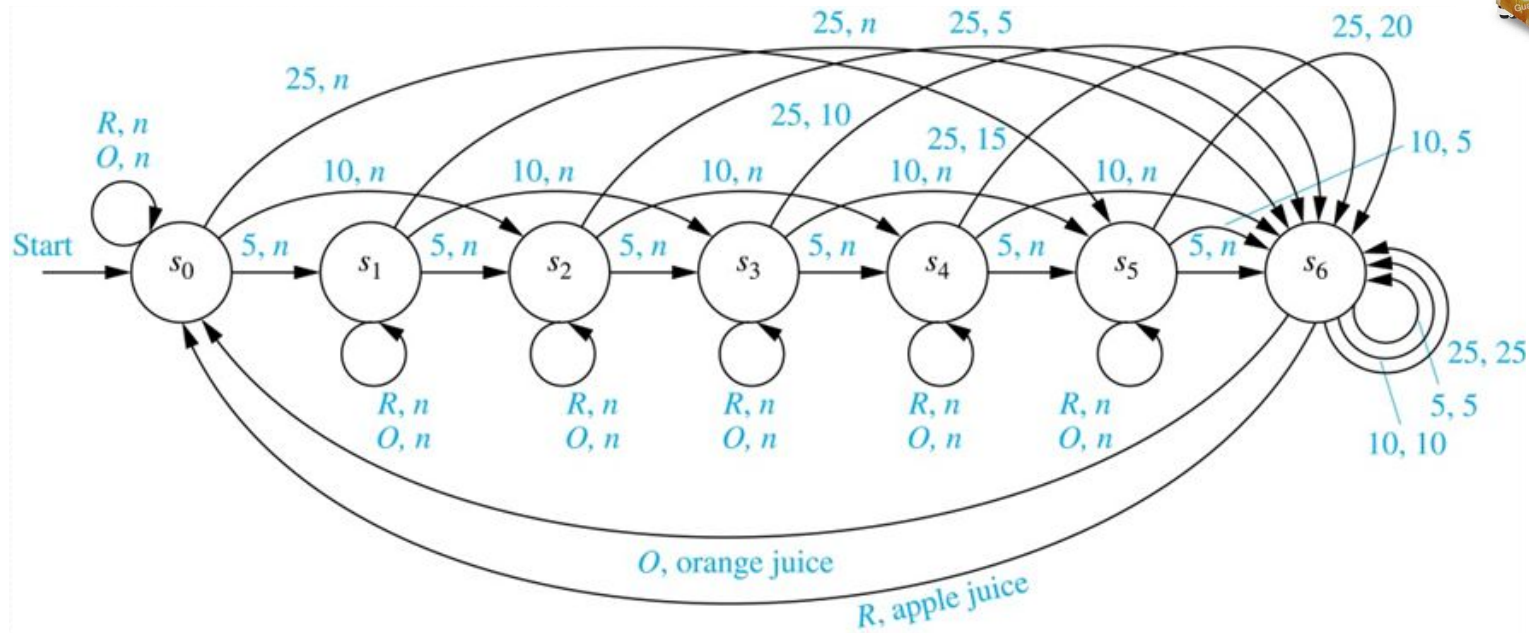

- All states are explicitly represented (unlike Petrinets, for example)
- Flat representation (no hierarchy)
- Does not scale well: becomes too large too quickly to be usable (by humans)

Alternative Representation: Parnas Tables

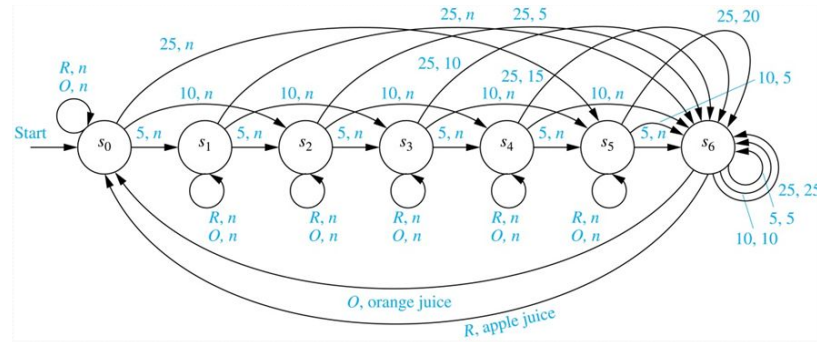

event \ state	s_0	s_1	s_2	s_3	s_4	s_5	s_6
5	s_1, n	s_2, n	s_3, n	s_4, n	s_5, n	s_6, n	$s_6, 5$
10	s_2, n	s_3, n	s_4, n	s_5, n	s_6, n	$s_6, 5$	$s_6, 10$
25	s_5, n	s_6, n	$s_6, 5$	$s_6, 10$	$s_6, 15$	$s_6, 20$	$s_6, 25$
O	s_0, n	s_1, n	s_2, n	s_3, n	s_4, n	s_5, n	$s_0, \text{orange juice}$
R	s_0, n	s_1, n	s_2, n	s_3, n	s_4, n	s_5, n	$s_0, \text{apple juice}$

Mealy and Moore Machines

FSA: $(Q, q_0, \Sigma, O, \delta, \lambda)$

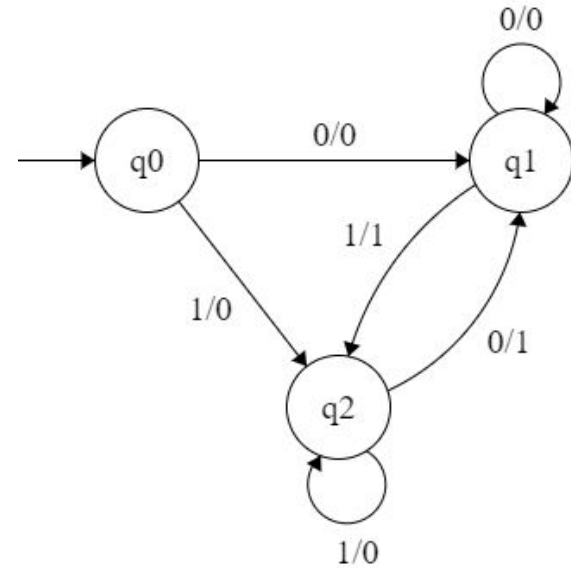
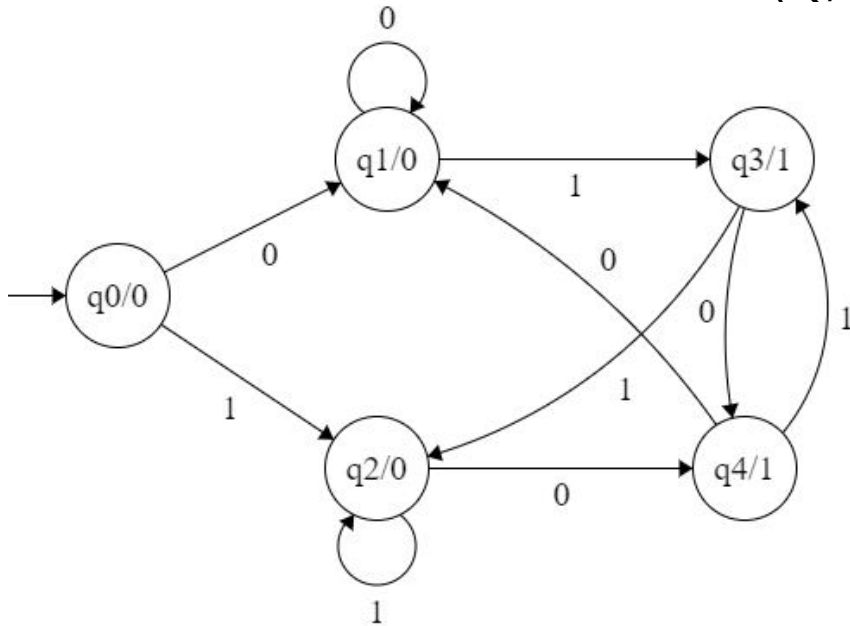

Moore Machines

- Output only depends on current state.
 $\lambda: Q \rightarrow O$
- Input stream: 00 \rightarrow
Output stream: 111

Mealy Machines

- Output depends on current state and on current input.
 $\lambda: Q \times \Sigma \rightarrow O$
- Input stream: 00 \rightarrow
Output stream: 11

FSAs: Expressiveness

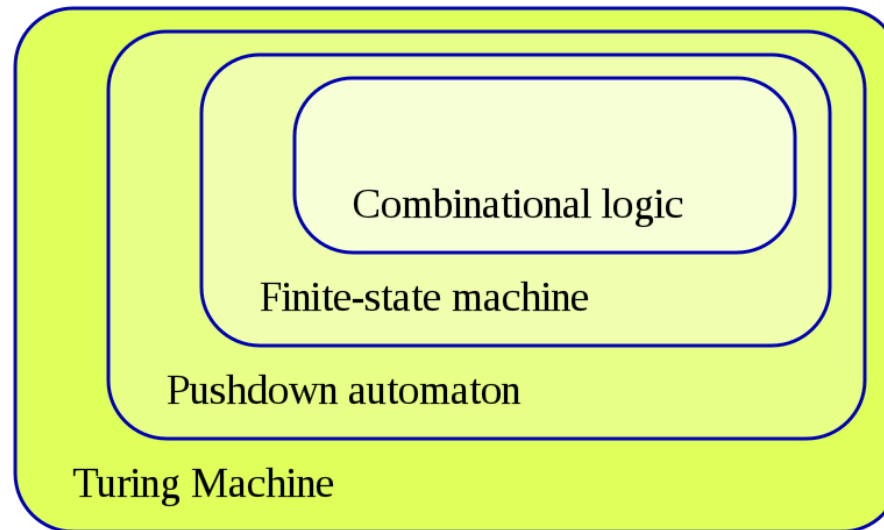
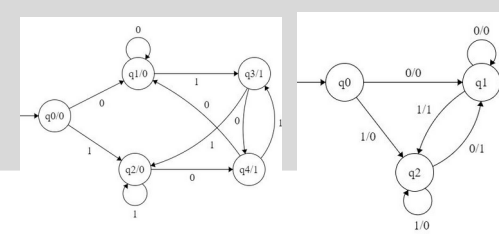

- Can be made Turing-complete
 - data memory, control flow, branching
- Extend FSAs
 - borrow semantics from Mealy and Moore machines

Higraphs

Higraphs

Euler Diagrams

All A are B .

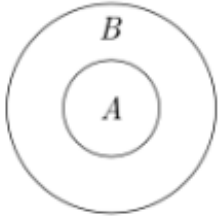

No A is B .



Some A is in B .

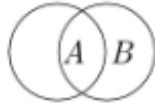

Some A is not in B .

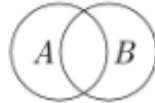

topological notions for set union, difference, intersection

Higraphs

Euler Diagrams

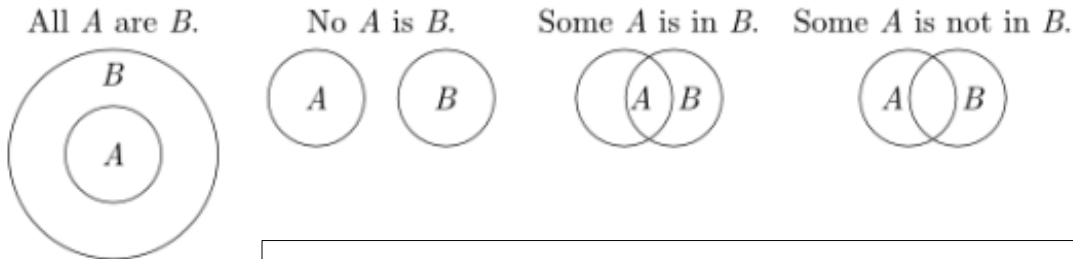

topological notions for set union, difference, intersection

Hypergraphs

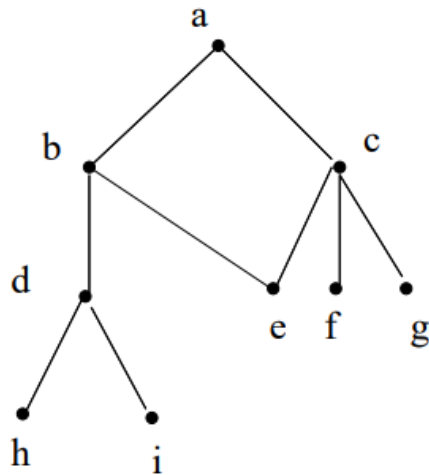

a graph

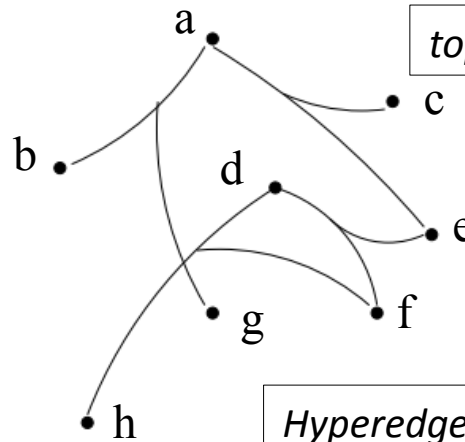

topological notion (syntax): connectedness

Hyperedges: $\subseteq 2^X$ (undirected), $\subseteq 2^X \times 2^X$ (directed).

a hypergraph

$X = \{a, b, \dots, h\}$

Higraphs

Euler Diagrams

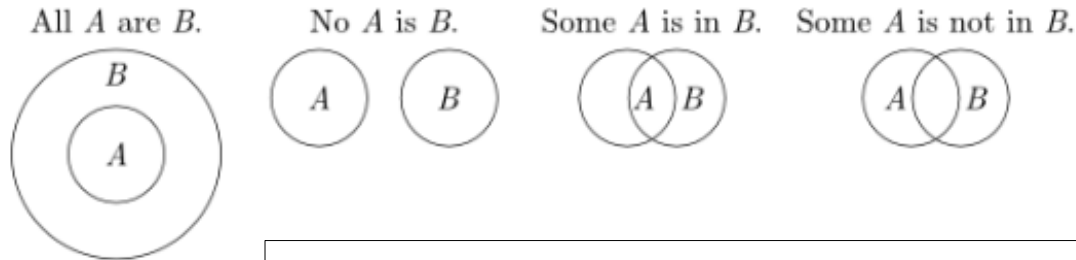

topological notions for set union, difference, intersection

Unordered Cartesian Product

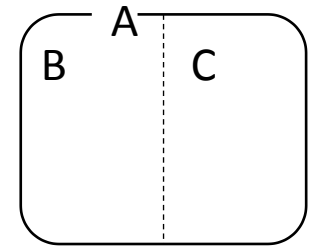

$$A = B \otimes C$$

Hypergraphs

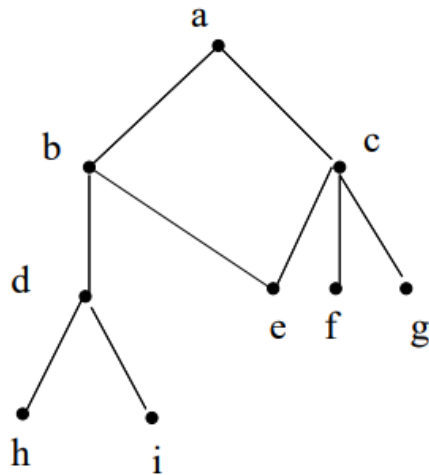

a graph

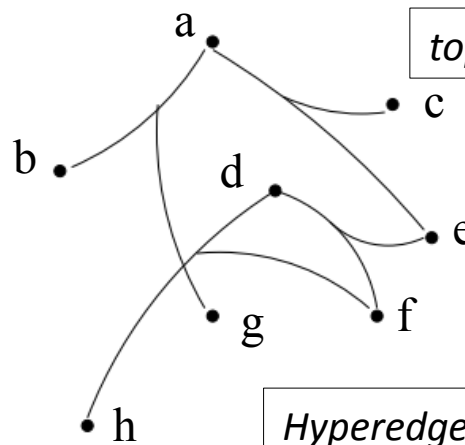

a hypergraph

topological notion (syntax): connectedness

Hyperedges: $\subseteq 2^X$ (undirected), $\subseteq 2^X \times 2^X$ (directed).

$$X = \{a, b, \dots, h\}$$

Higraphs

Euler Diagrams

+

Hypergraphs

+

Unordered Cartesian Product

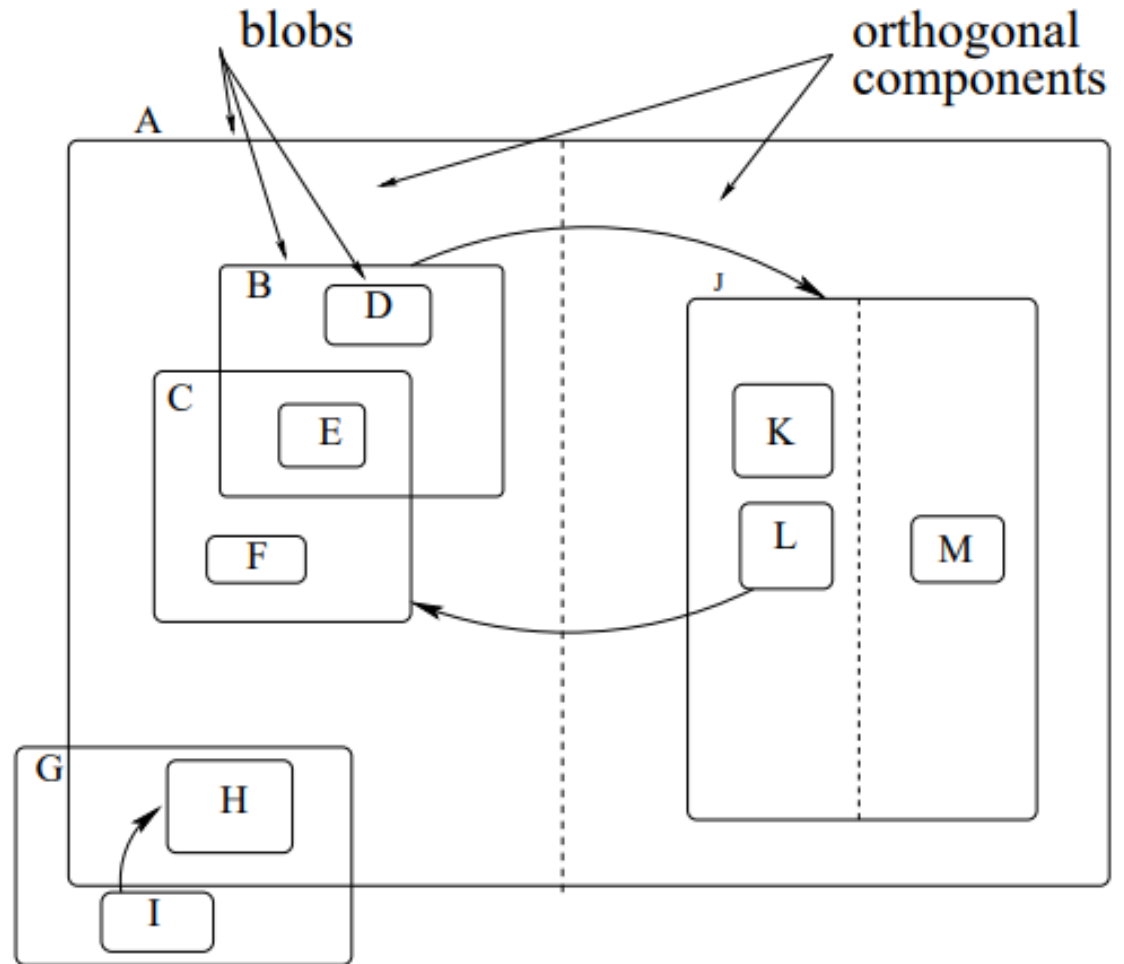

Higraph: Examples

- Clique

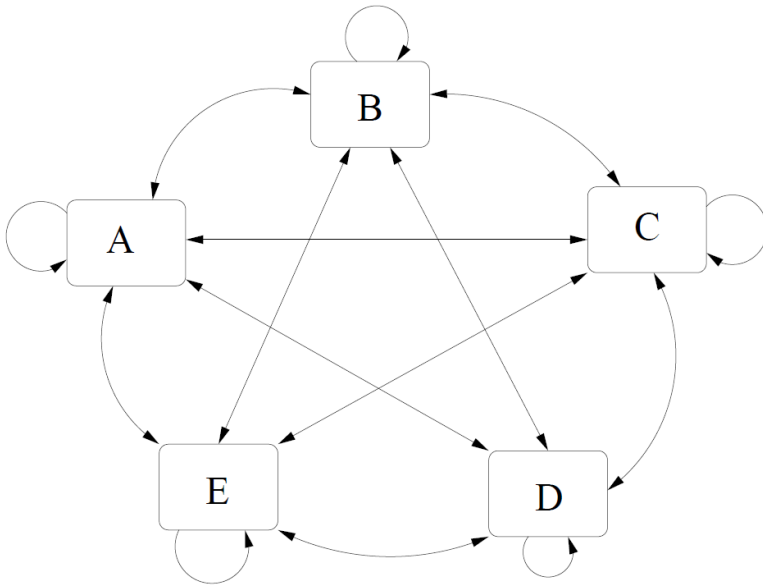

Higraph: Examples

- Clique

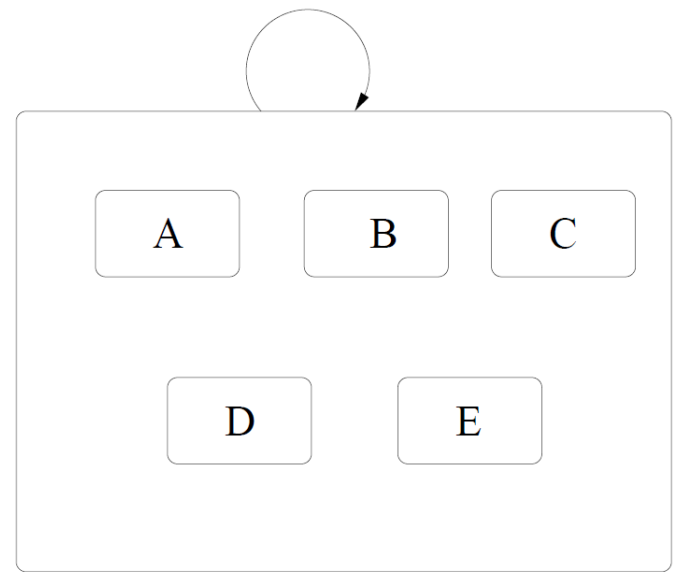
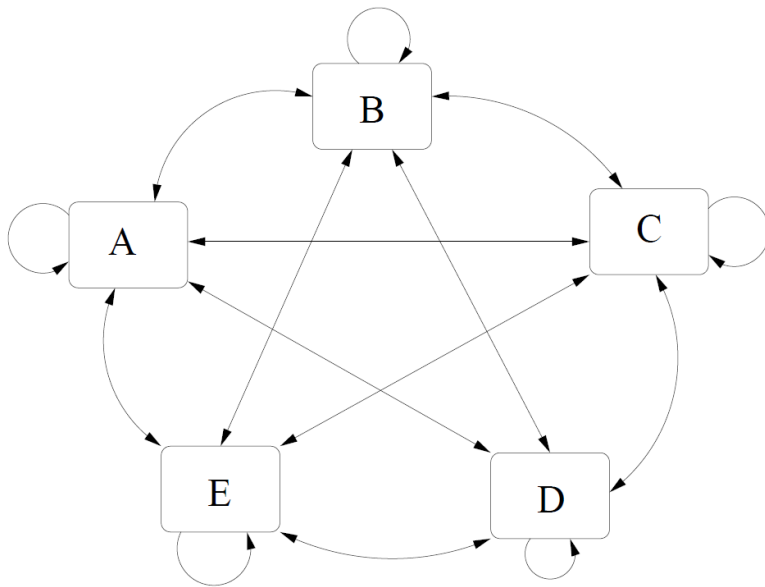

Higraphs: Examples

- ER-Diagrams

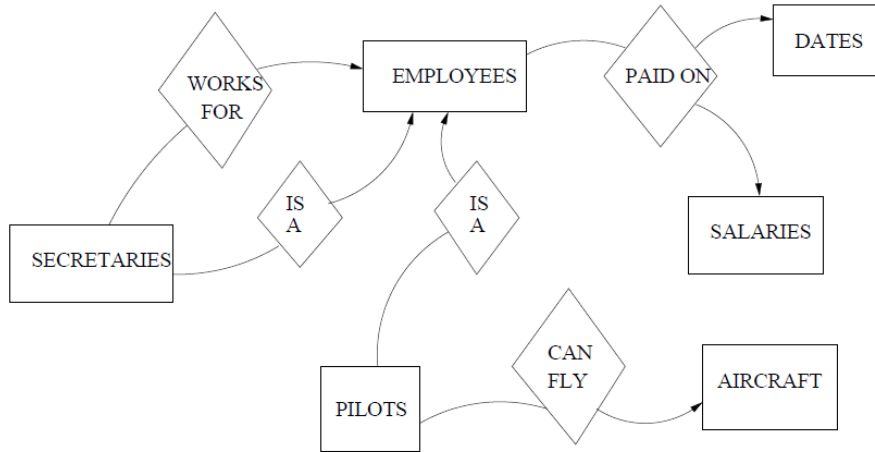

Higraphs: Examples

- ER-Diagrams

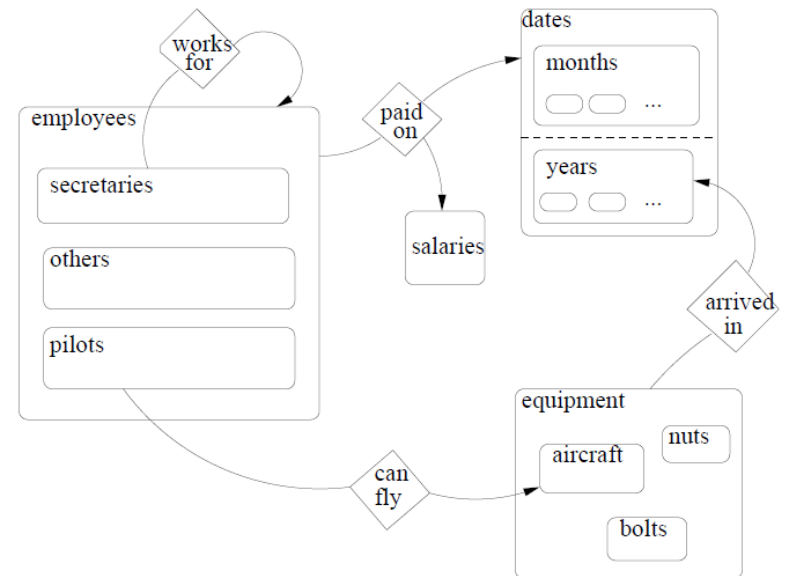
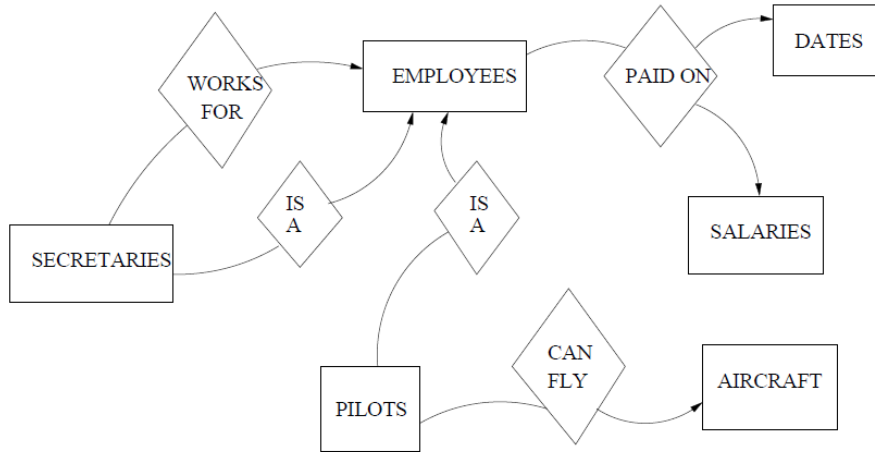

Higraphs: Formal Definition

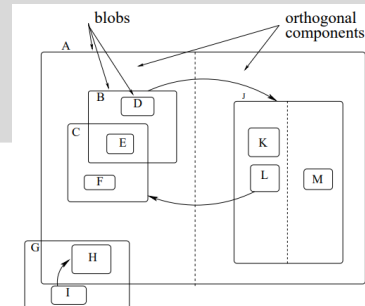

- A higraph H is a quadruple

$$H = (B, E, \sigma, \pi)$$

- B is a finite set of all unique *blobs*
- E is a set of *hyperedges*

$$\subseteq 2^B \times 2^B$$

- The subblob function σ

$$\sigma: B \rightarrow 2^B$$

$$\sigma^0(x) = \{x\}, \quad \sigma^{i+1}(x) = \bigcup_{y \in \sigma^i(x)} \sigma(y), \quad \sigma^+(x) = \bigcup_{i=1} \sigma^i(x)$$

Higraphs: Formal Definition

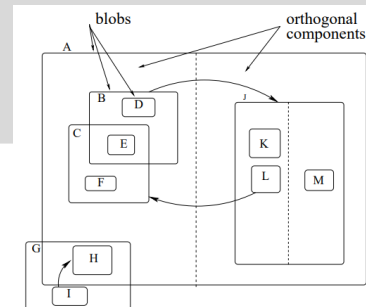

- Subblobs relation cycle-free

$$x \notin \sigma^+(x)$$

- The partitioning function π associates an *equivalence relationship* with x

$$\pi : B \rightarrow 2^{B \times B}$$

- Equivalence classes π_i are orthogonal components of x

$$\pi_1(x), \pi_2(x), \dots, \pi_{k_x}(x)$$

- $k_x = 1$ means a single orthogonal component

- Blobs in different orthogonal components of x are disjoint

$$\forall y, z \in \sigma(x) : \sigma^+(y) \cap \sigma^+(z) = \emptyset$$

Higraphs Applications

- Apply syntactic constructs to an existing modelling language.
- Add specific meaning to these constructs.
- Examples:
 - E-R diagrams
 - Dataflow/Activity Diagrams
 - Inheritance
 - **Statecharts**

Statecharts

Statecharts

- Visual (topological, not geometric) formalism

Statecharts

- Visual (topological, not geometric) formalism
- Precisely defined syntax and semantics

Statecharts

- Visual (topological, not geometric) formalism
- Precisely defined syntax and semantics
- Many uses:
 - Documentation (for human communication)
 - Analysis (of behavioural properties)
 - Simulation
 - Code synthesis
 - ... and derived, such as testing, optimization, ...

Statecharts

- Visual (topological, not geometric) formalism
- Precisely defined syntax and semantics
- Many uses:
 - Documentation (for human communication)
 - ~~Analysis (of behavioural properties)~~
 - Simulation
 - Code synthesis
 - ... and derived, such as testing, optimization, ...

Statecharts History

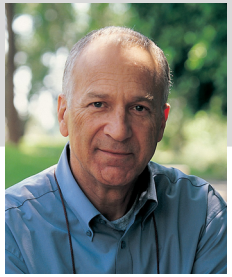

- Introduced by David Harel in 1987

Statecharts History

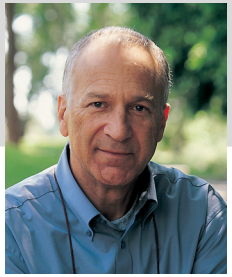

- Introduced by David Harel in 1987
- Notation based on higraphs = hypergraphs + Euler diagrams + unordered Cartesian product

Statecharts History

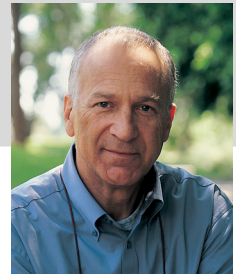

- Introduced by David Harel in 1987
- Notation based on higraphs = hypergraphs + Euler diagrams + unordered Cartesian product
- Semantics extends deterministic finite state automata with:
 - Depth (Hierarchy)
 - Orthogonality
 - Broadcast Communication
 - Time
 - History
 - Syntactic sugar, such as enter/exit actions

Statecharts History

- Incorporated in UML: State Machines (1995)
- More recent: xUML for semantics of UML subset (2002)
- W3 Recommendation: State Chart XML (SCXML) (2015)
<https://www.w3.org/TR/scxml/>
- Standard: Precise Semantics for State Machines (2019)
<https://www.omg.org/spec/PSSM/>

Statechart (Variants) Tools

STATEMATE: A Working Environment for the Development of Complex Reactive Systems

Rational software

<https://www.ibm.com/us-en/marketplace/systems-design-rhapsody>



Matlab

Simulink

Stateflow

<https://www.mathworks.com/products/stateflow.html>

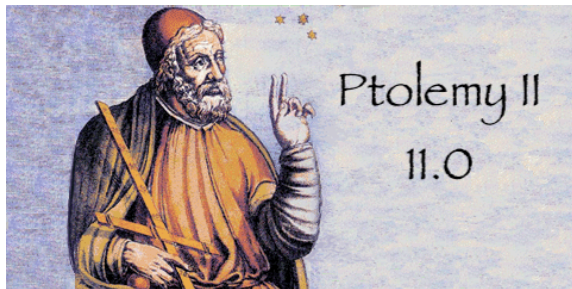

<https://ptolemy.berkeley.edu/ptolemyII/ptII11.0/index.htm>



<https://www.itemis.com/en/yakindu/state-machine/>



<https://www.eclipse.org/papyrus-rt/>

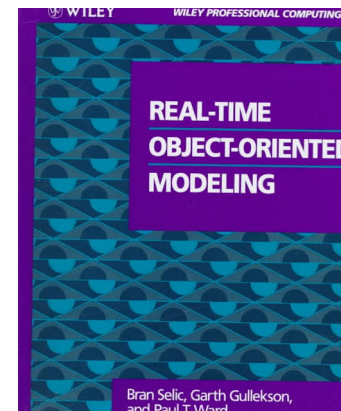

<https://www.eclipse.org/etrice/>

Running Example

(Physical) Plant



Running Example

Controller

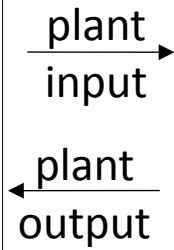

(Physical) Plant



Running Example

System

Controller



plant
input →
←
plant
output

(Physical) Plant



Running Example

System

Environment

Controller

(Physical) Plant



plant
input →
←
plant
output



<<sense>>

<<sense>>

<<act>>



Running Example

System

Environment

Controller

(Physical) Plant



plant
input →
←
plant
output

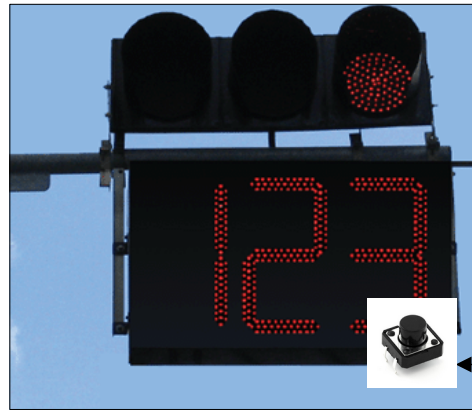

<<sense>>

<<sense>>

<<act>>



What are we developing?

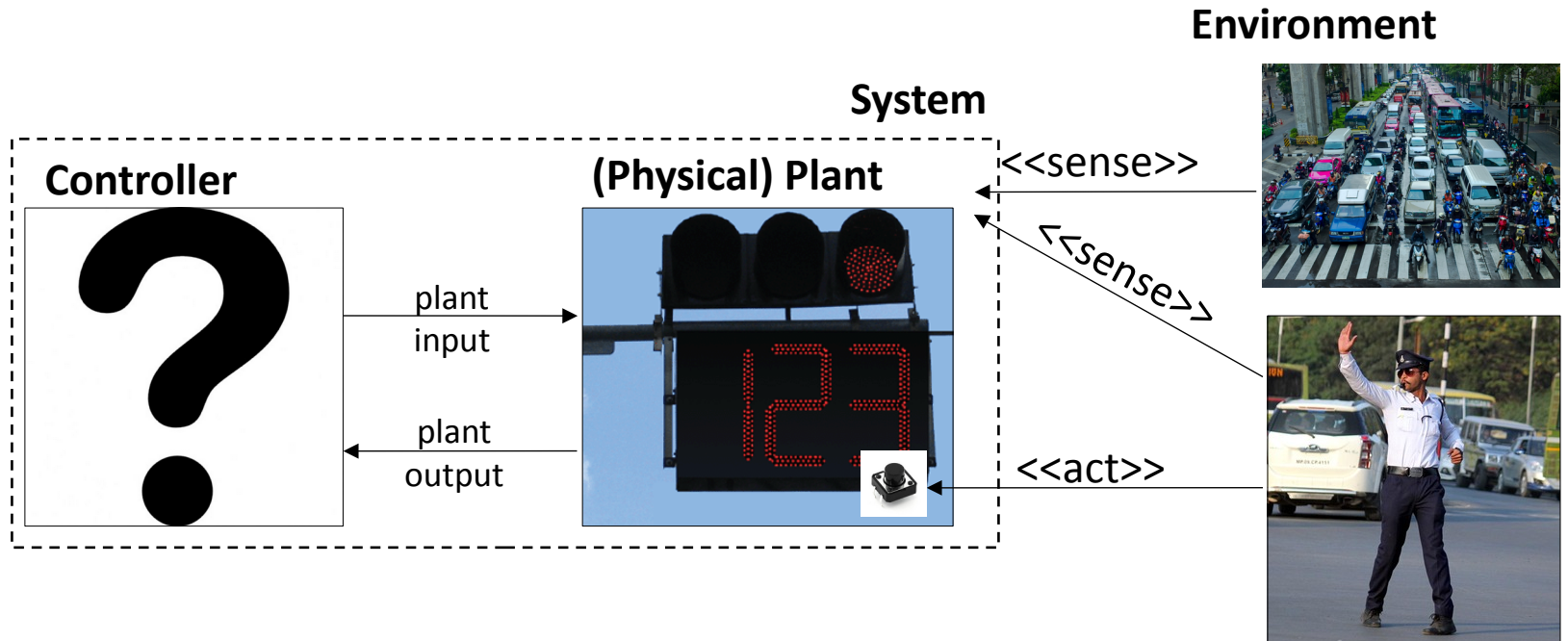

What are we developing?

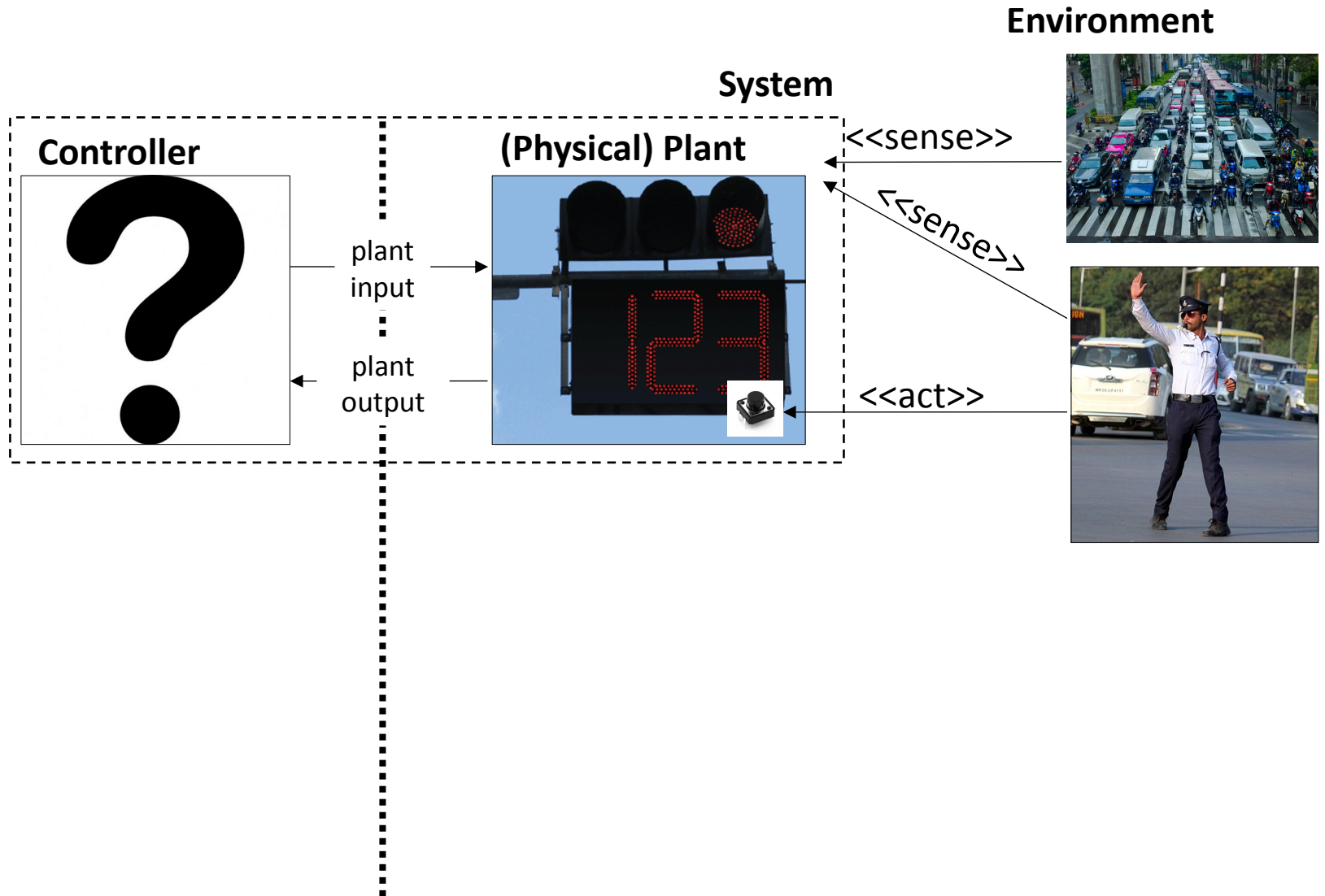

What are we developing?

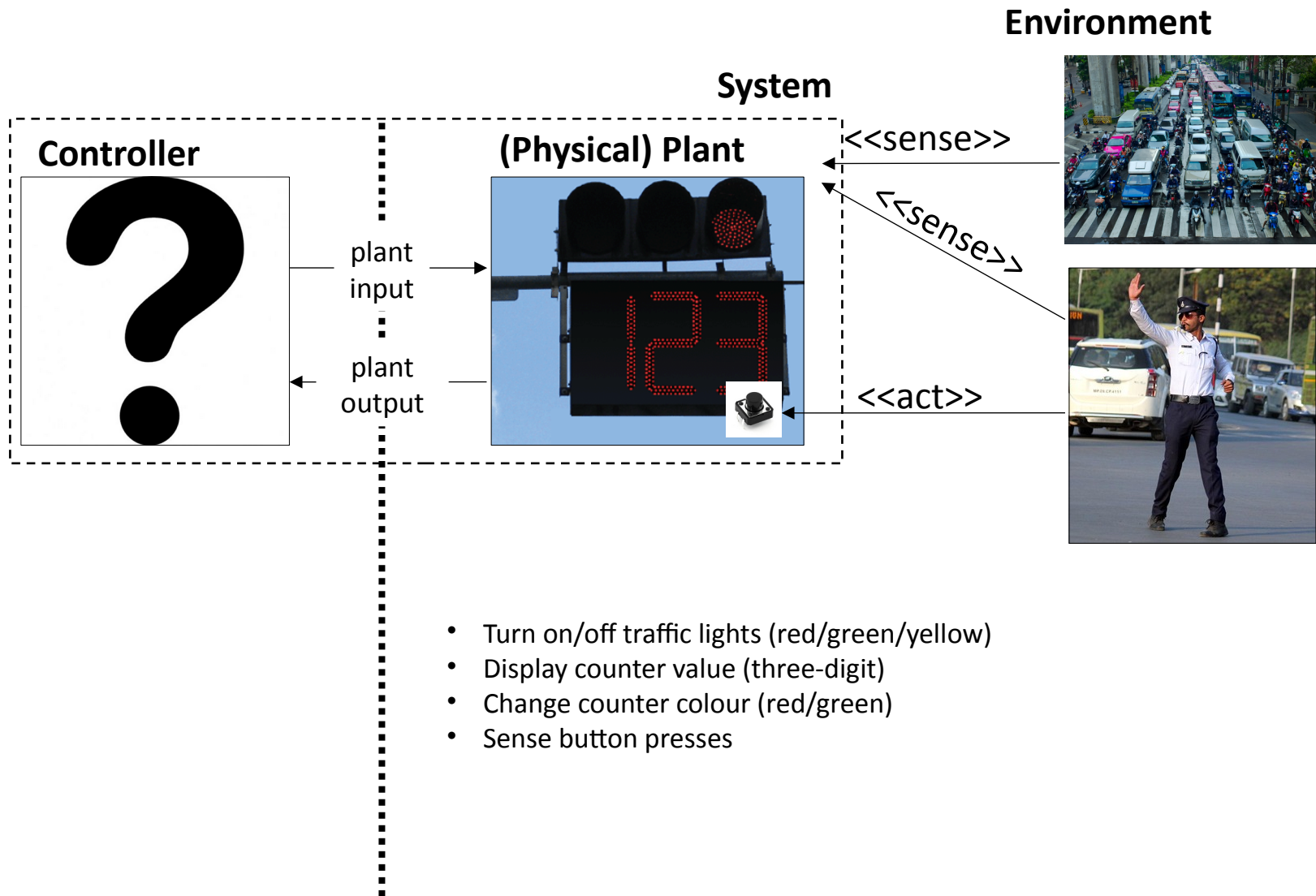

What are we developing?

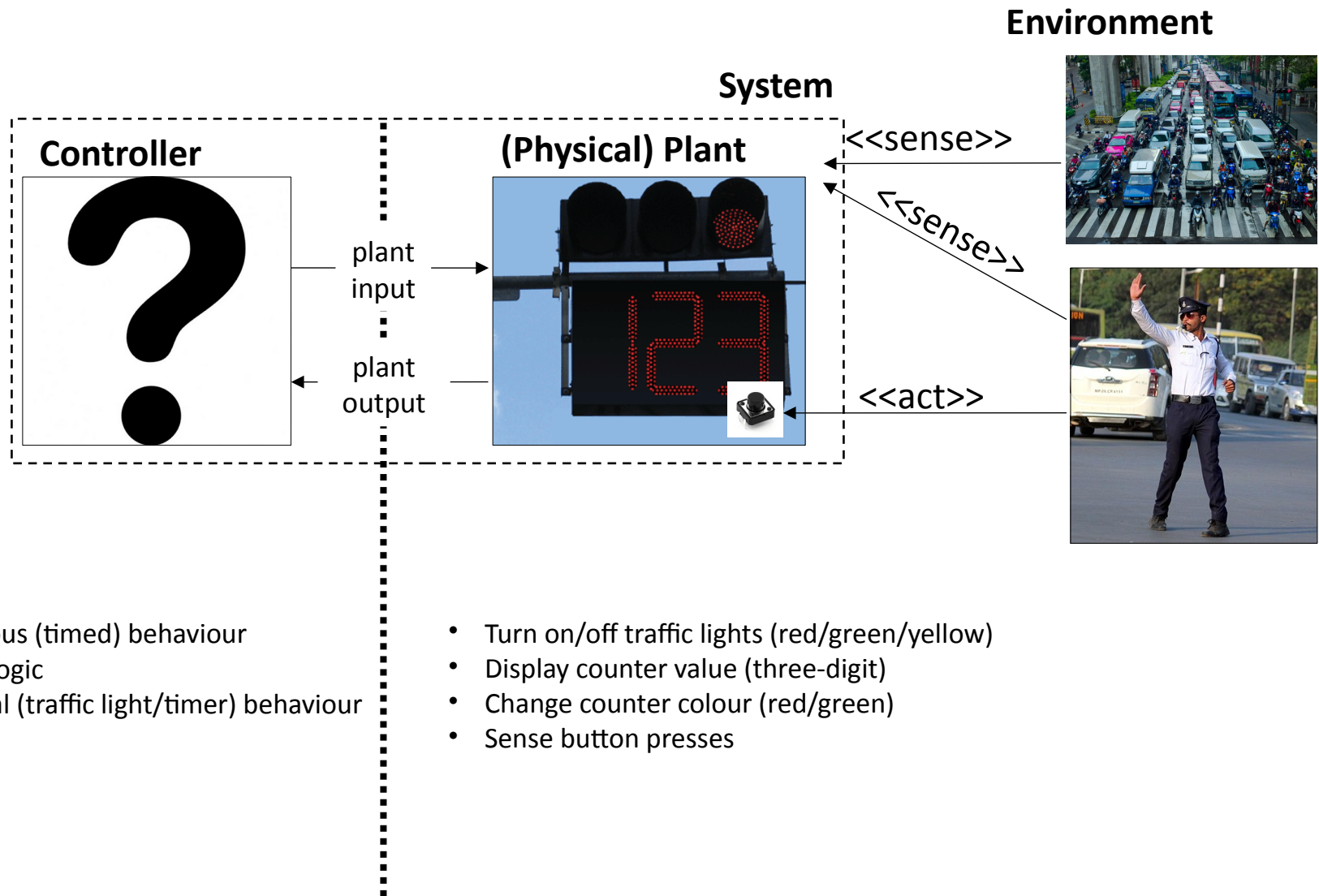

- Autonomous (timed) behaviour
- Interrupt logic
- Orthogonal (traffic light/timer) behaviour

- Turn on/off traffic lights (red/green/yellow)
- Display counter value (three-digit)
- Change counter colour (red/green)
- Sense button presses

What are we developing?

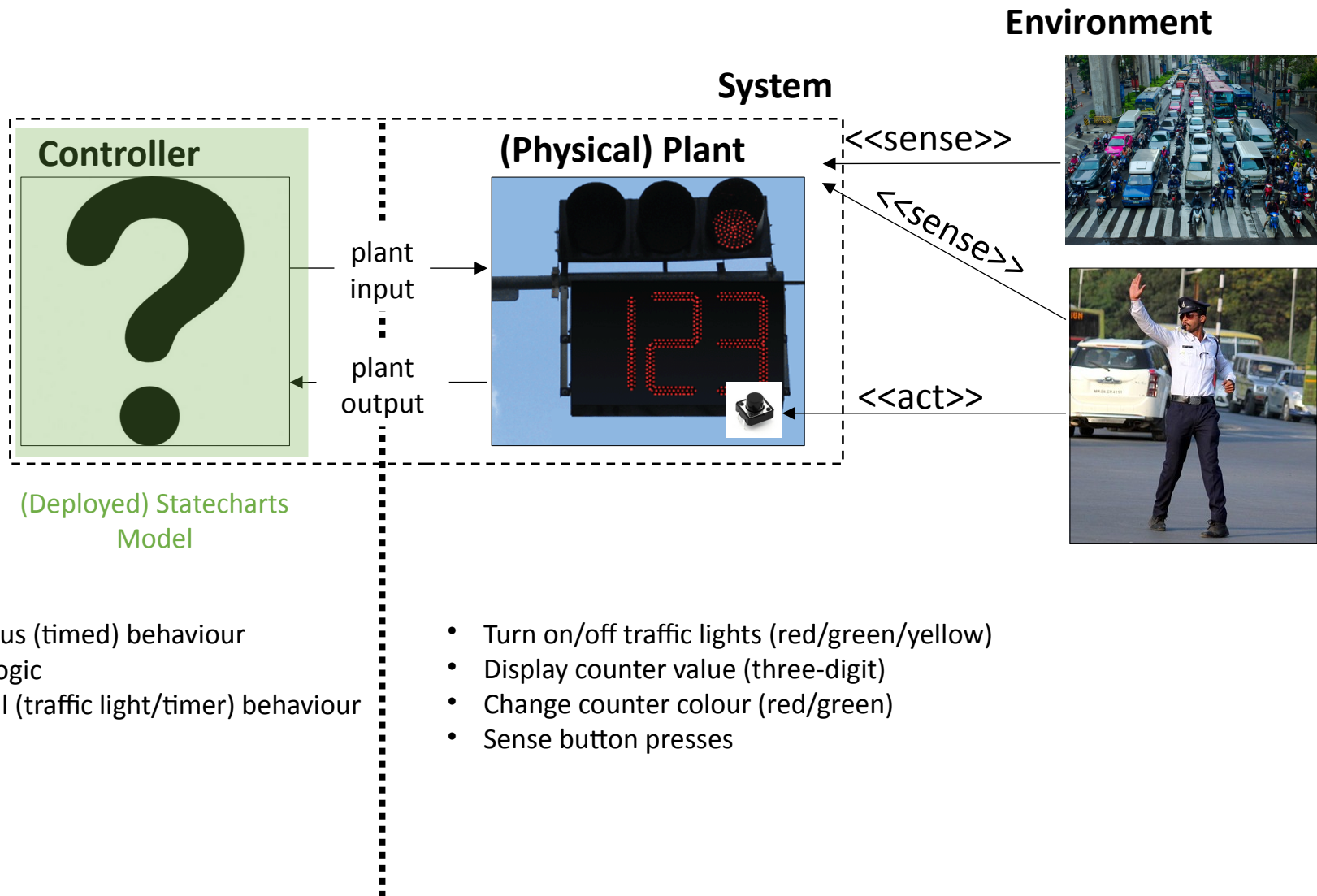

- Autonomous (timed) behaviour
- Interrupt logic
- Orthogonal (traffic light/timer) behaviour

- Turn on/off traffic lights (red/green/yellow)
- Display counter value (three-digit)
- Change counter colour (red/green)
- Sense button presses

What are we developing?

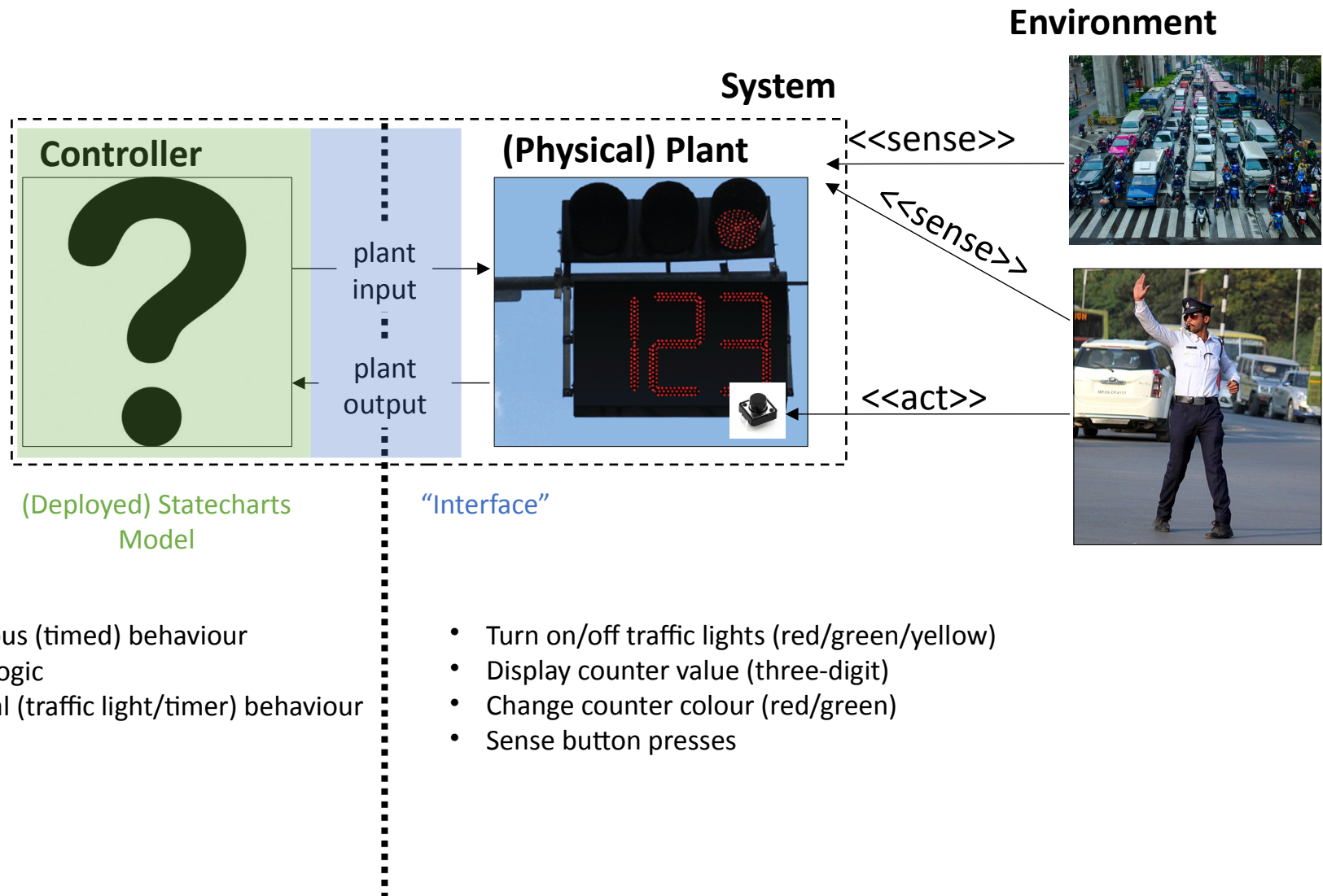

- Autonomous (timed) behaviour
- Interrupt logic
- Orthogonal (traffic light/timer) behaviour

- Turn on/off traffic lights (red/green/yellow)
- Display counter value (three-digit)
- Change counter colour (red/green)
- Sense button presses

Deployment (Simulation)

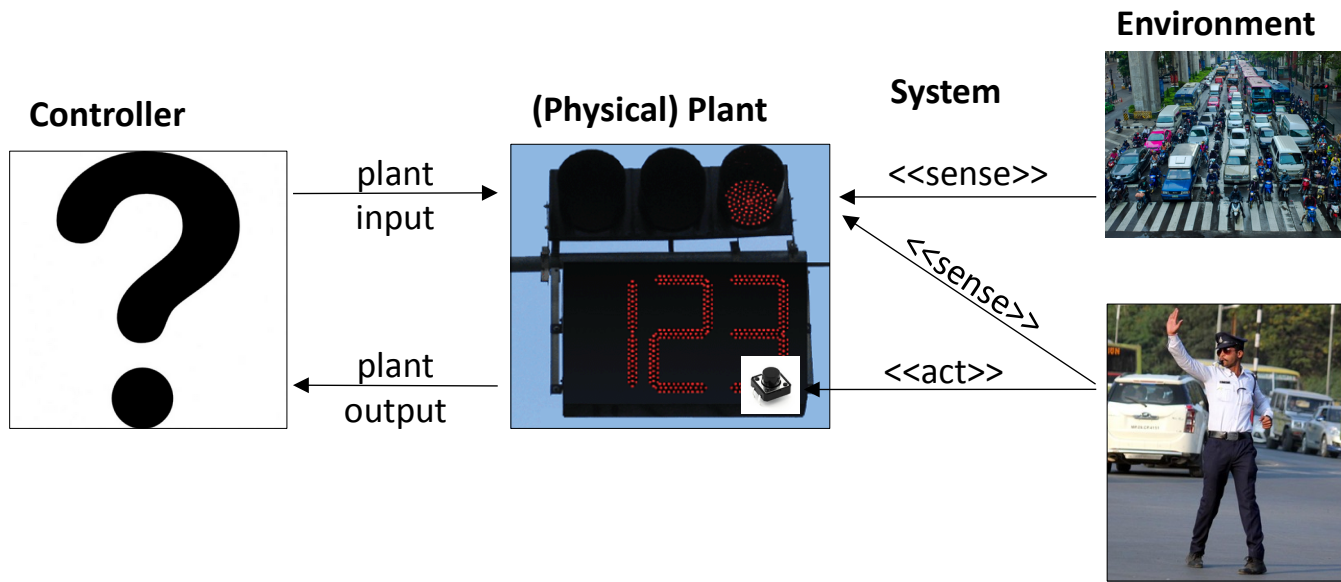

Deployment (Simulation)

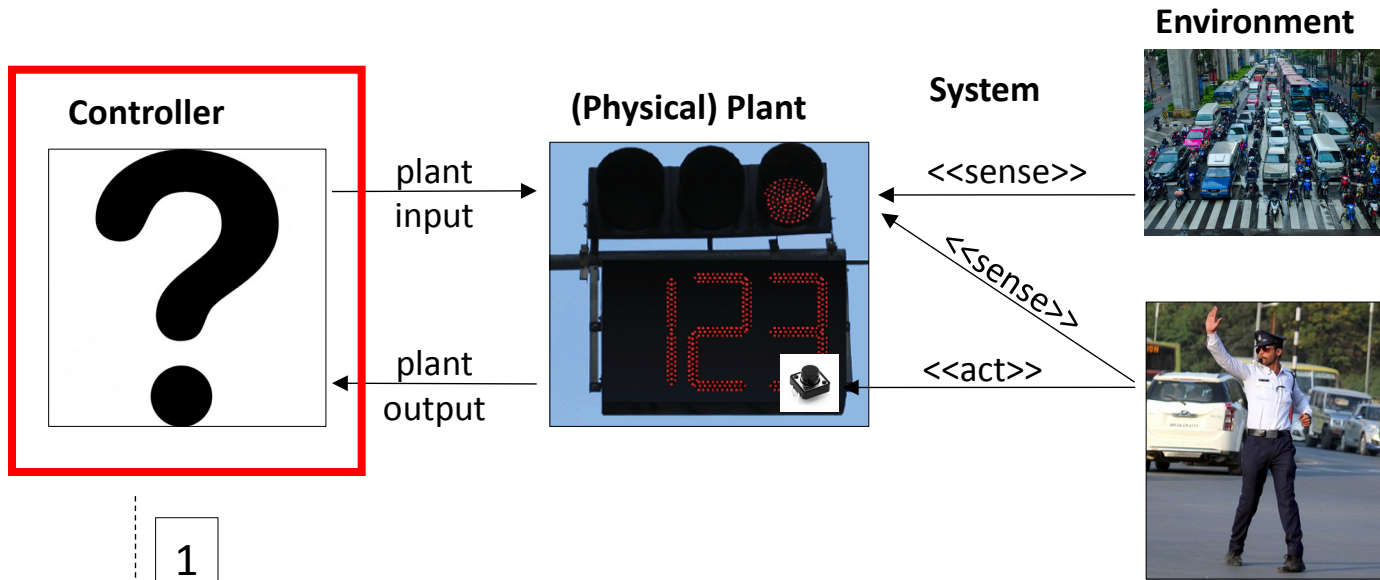

1

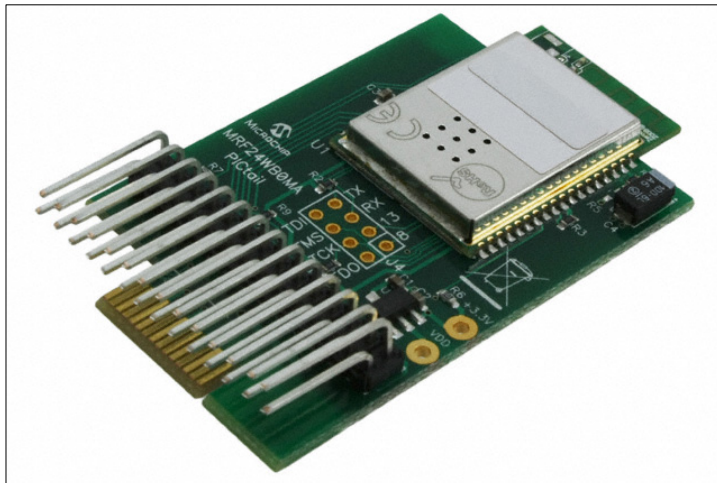

Deployment (Simulation)

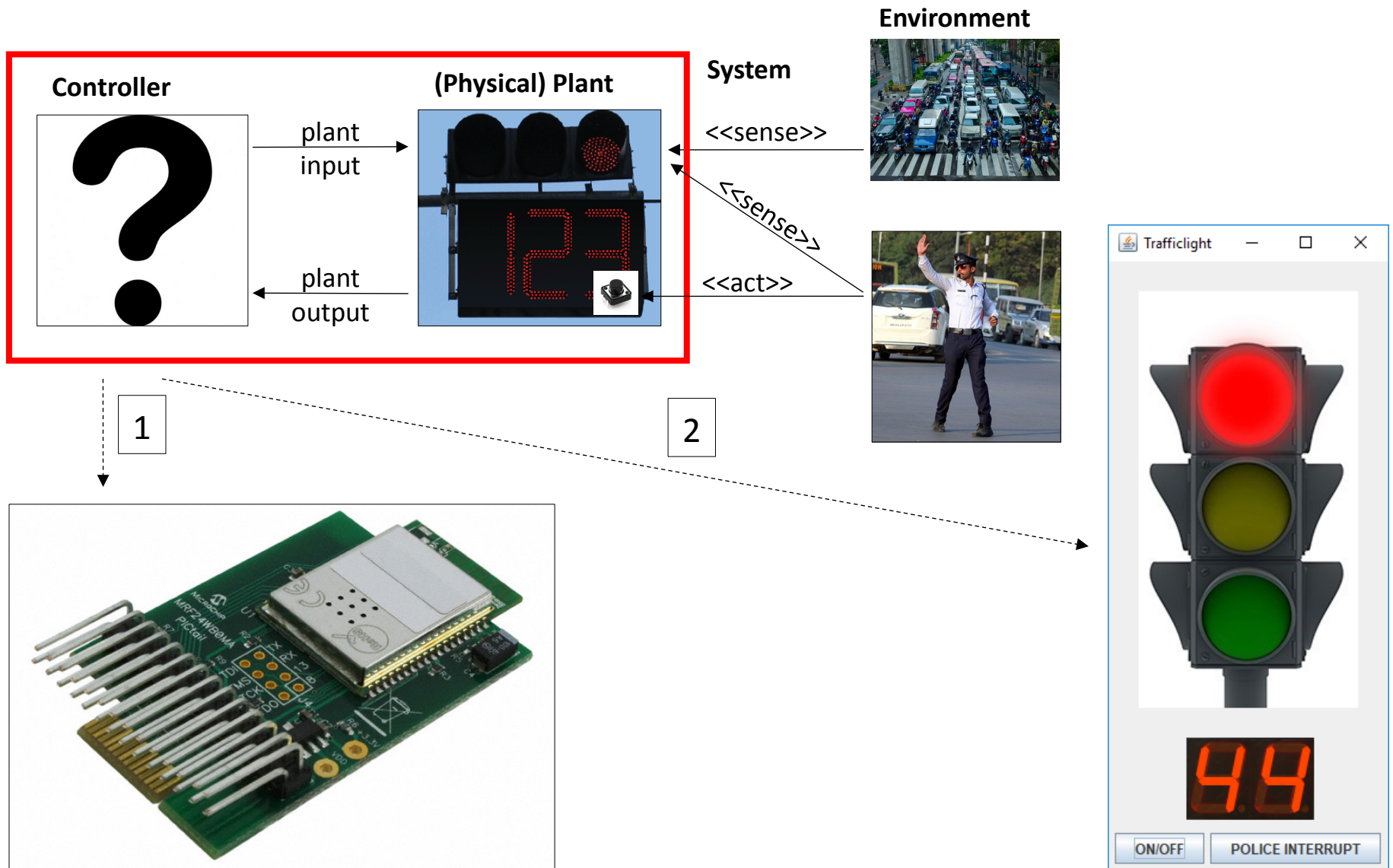

Deployment (Simulation)

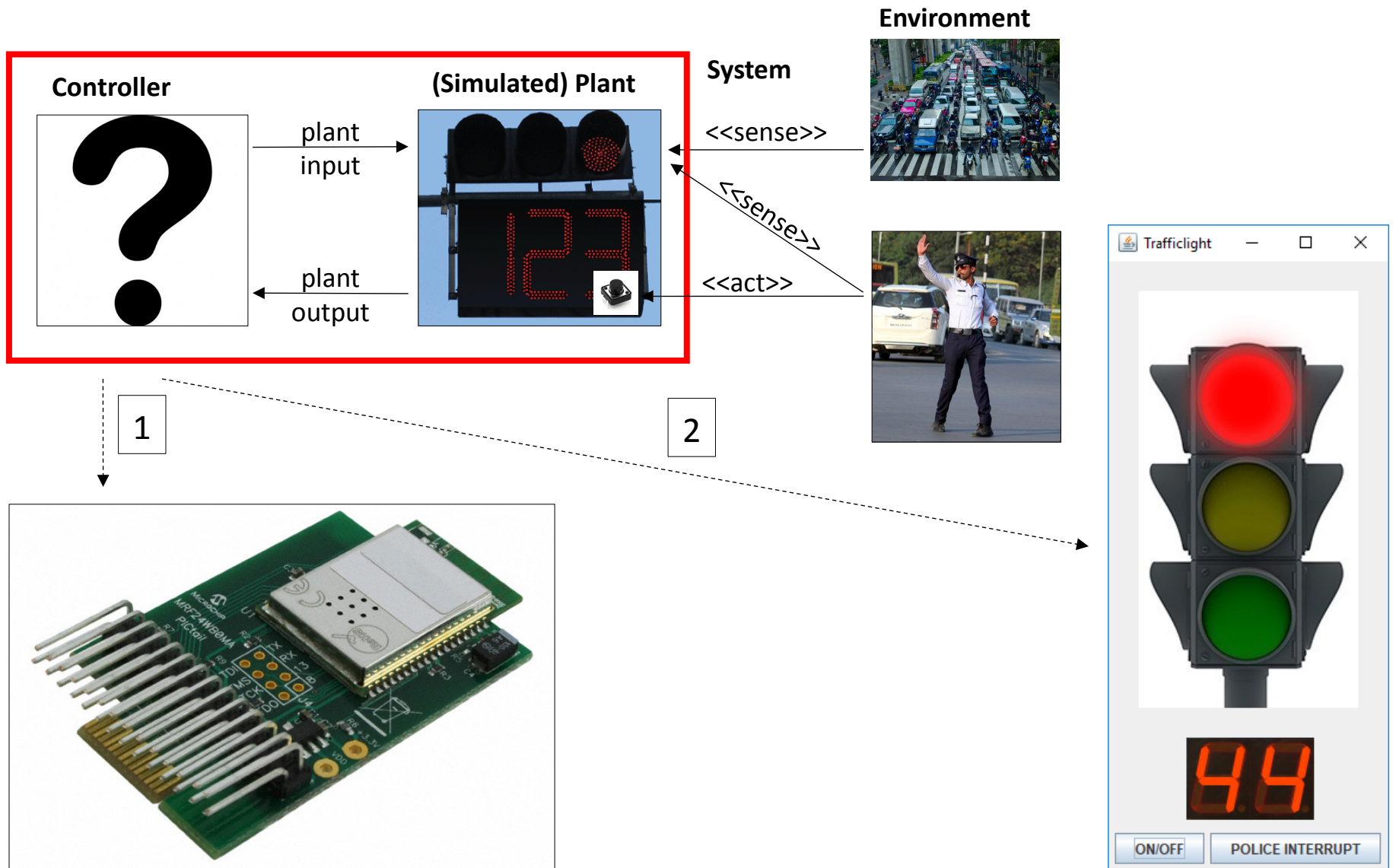

Deployment (Simulation)

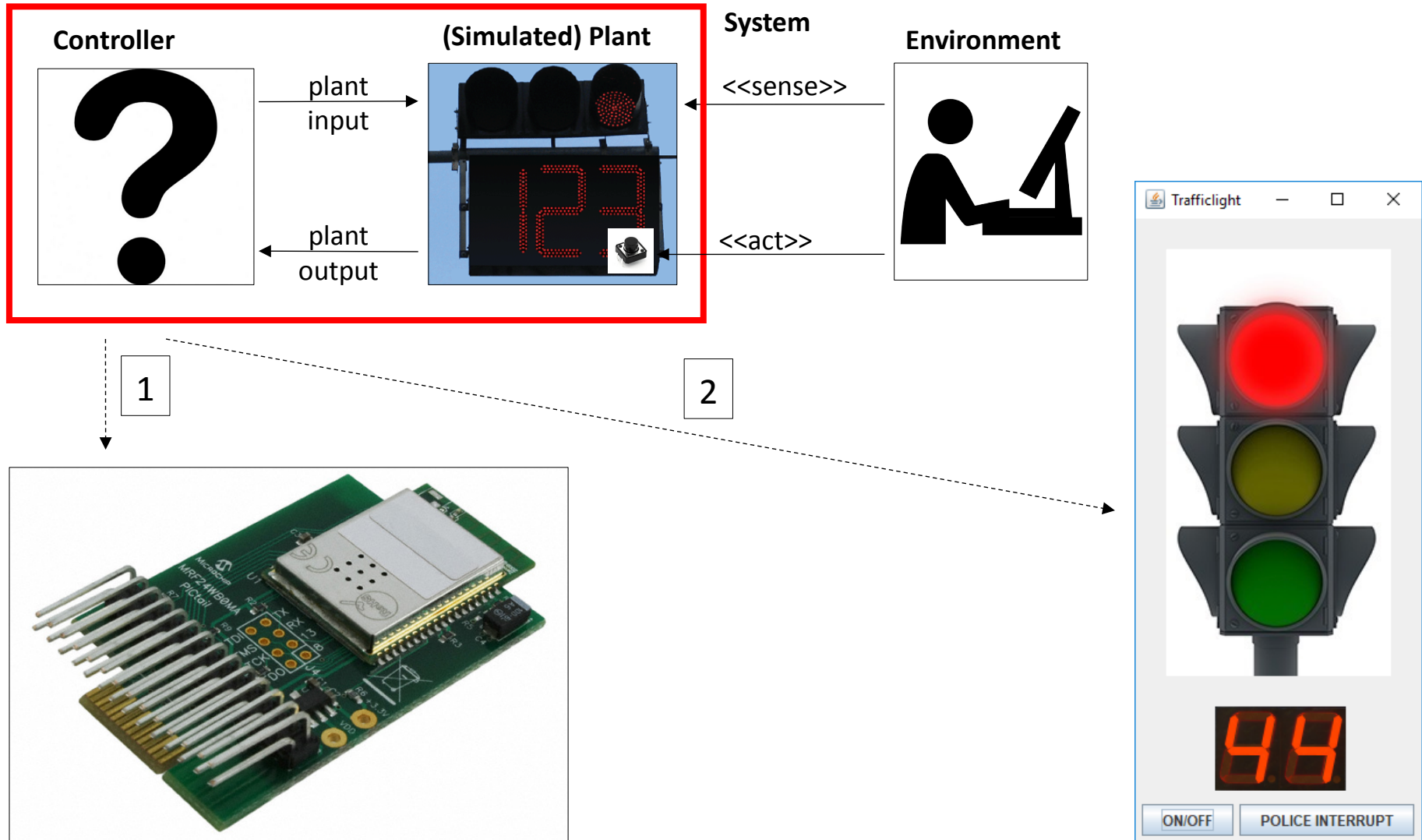

Deployment (Hardware)

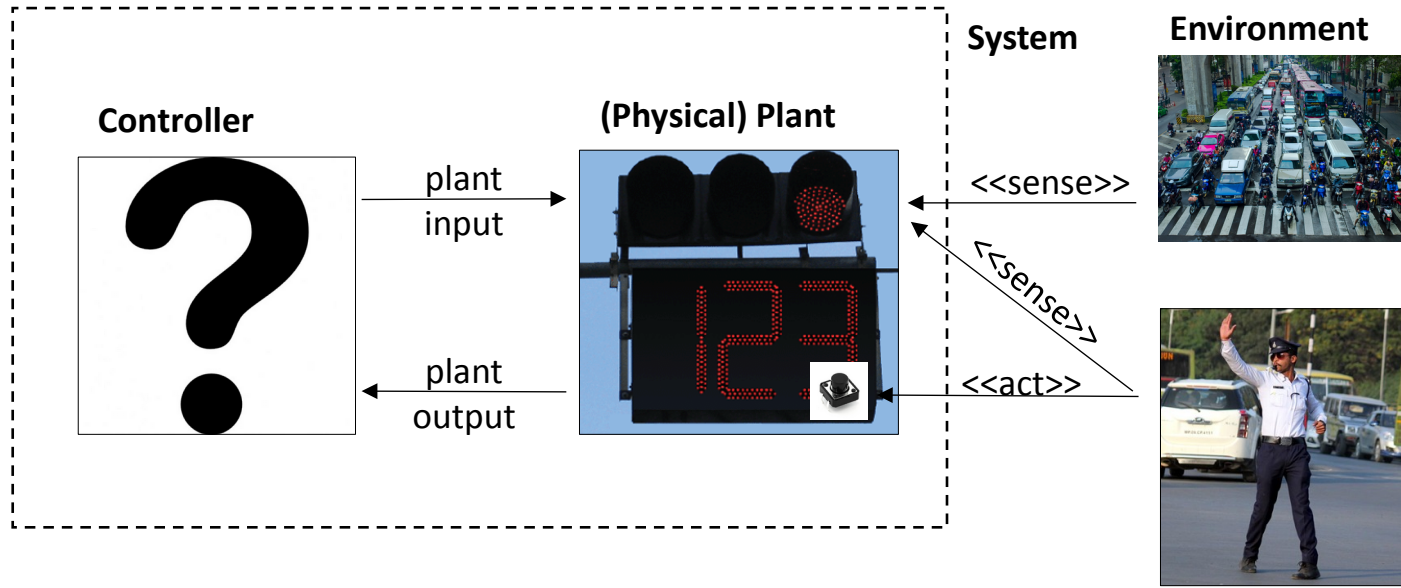

Deployment (Hardware)

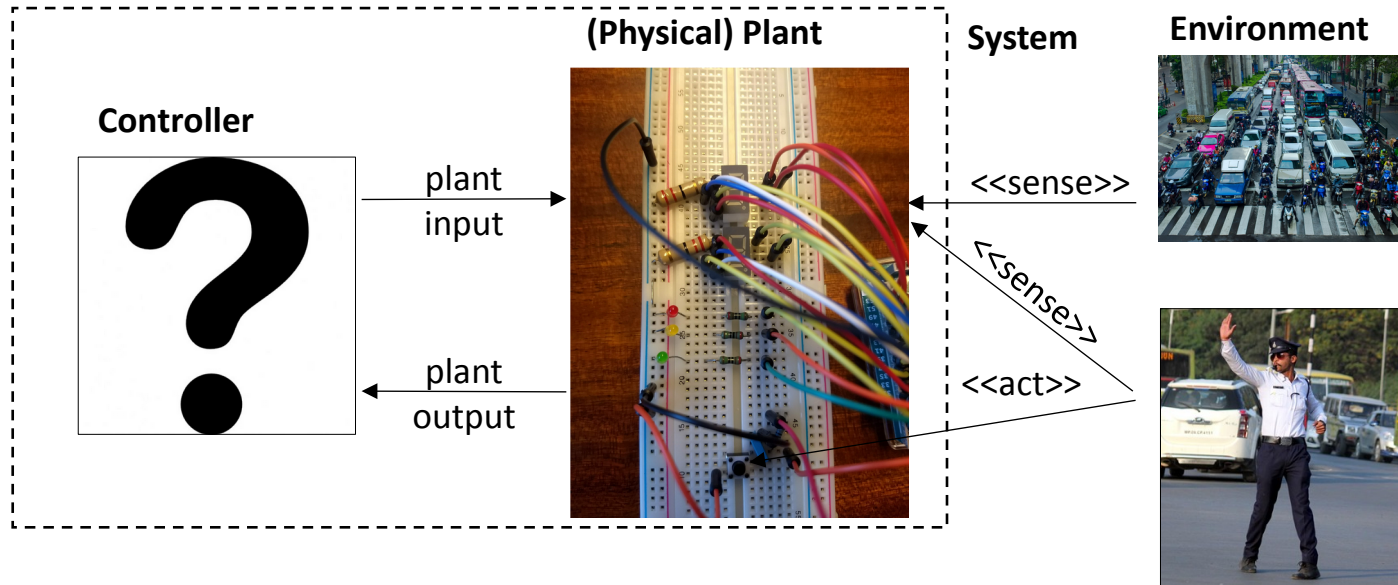

Deployment (Hardware)

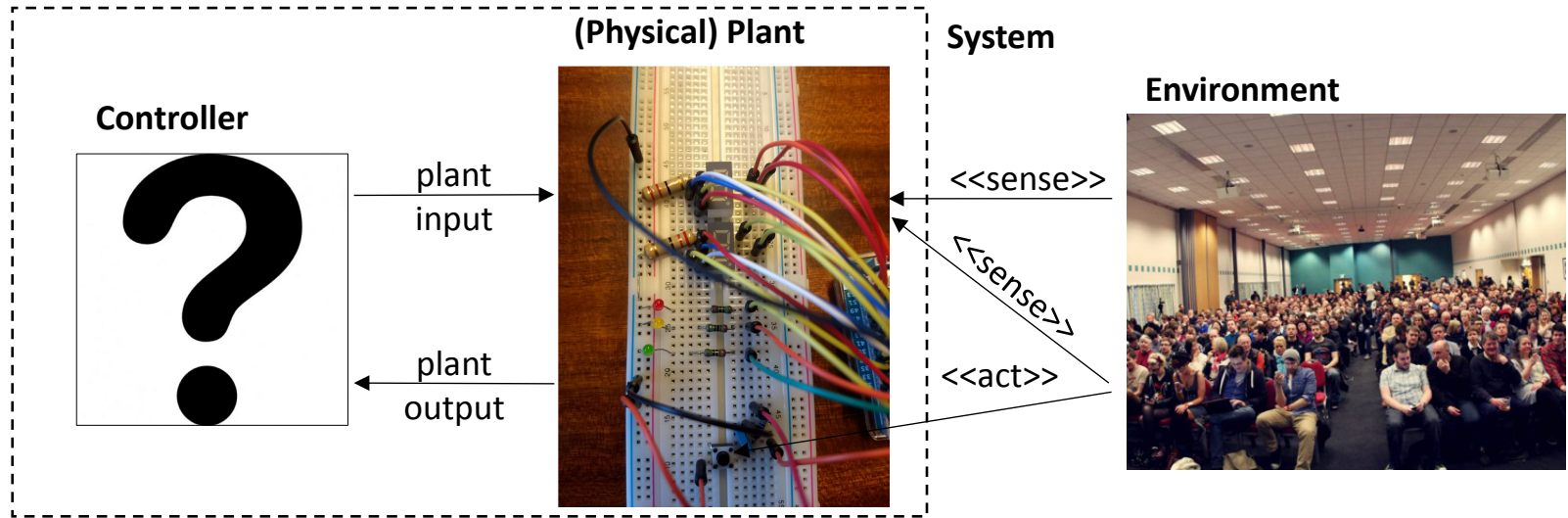

Deployment (Hardware)

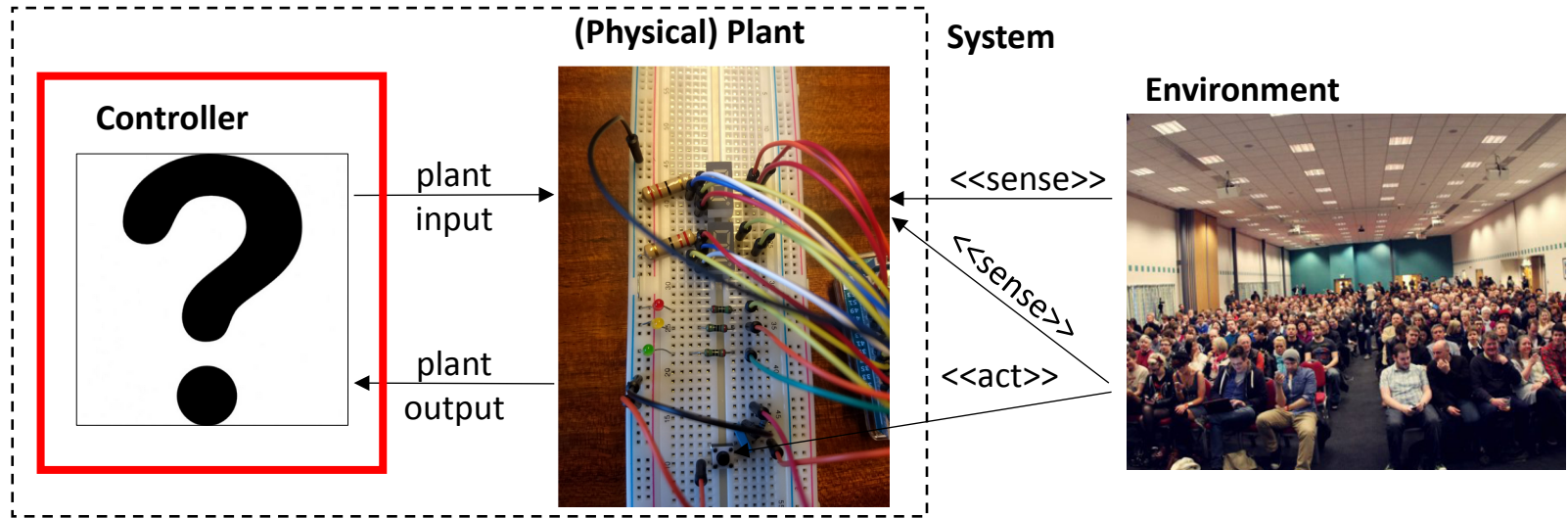

Deployment (Hardware)

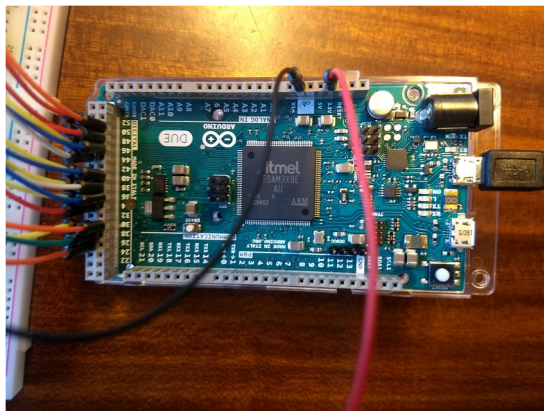
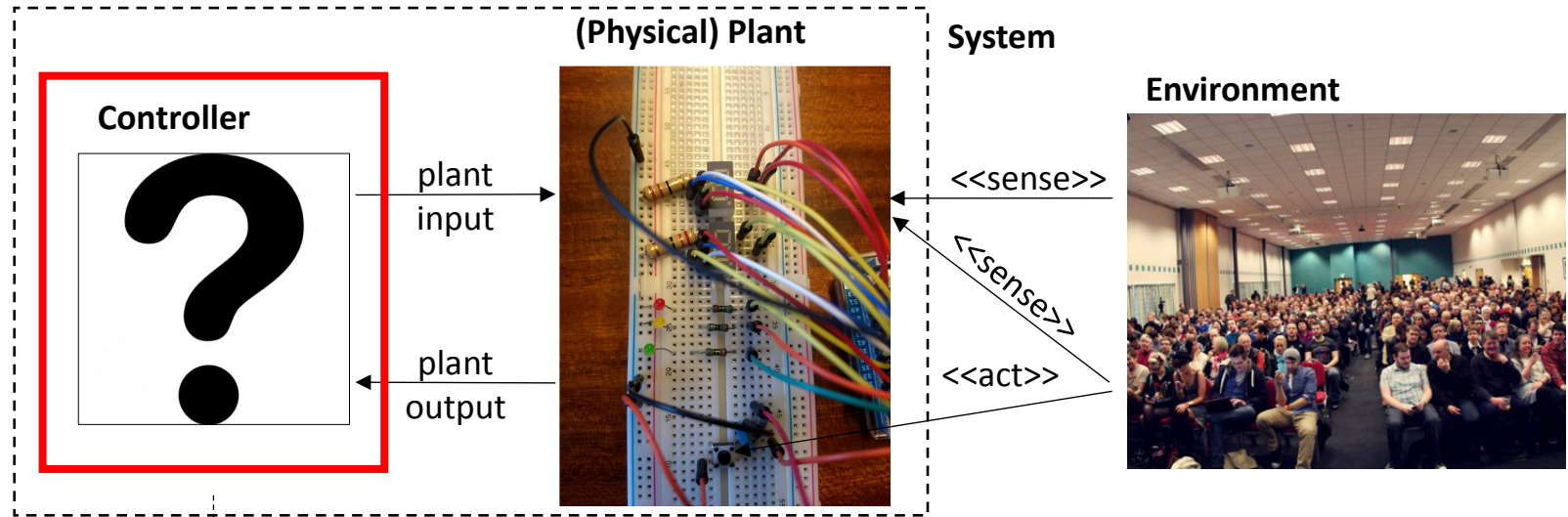

Deployment (Hardware)

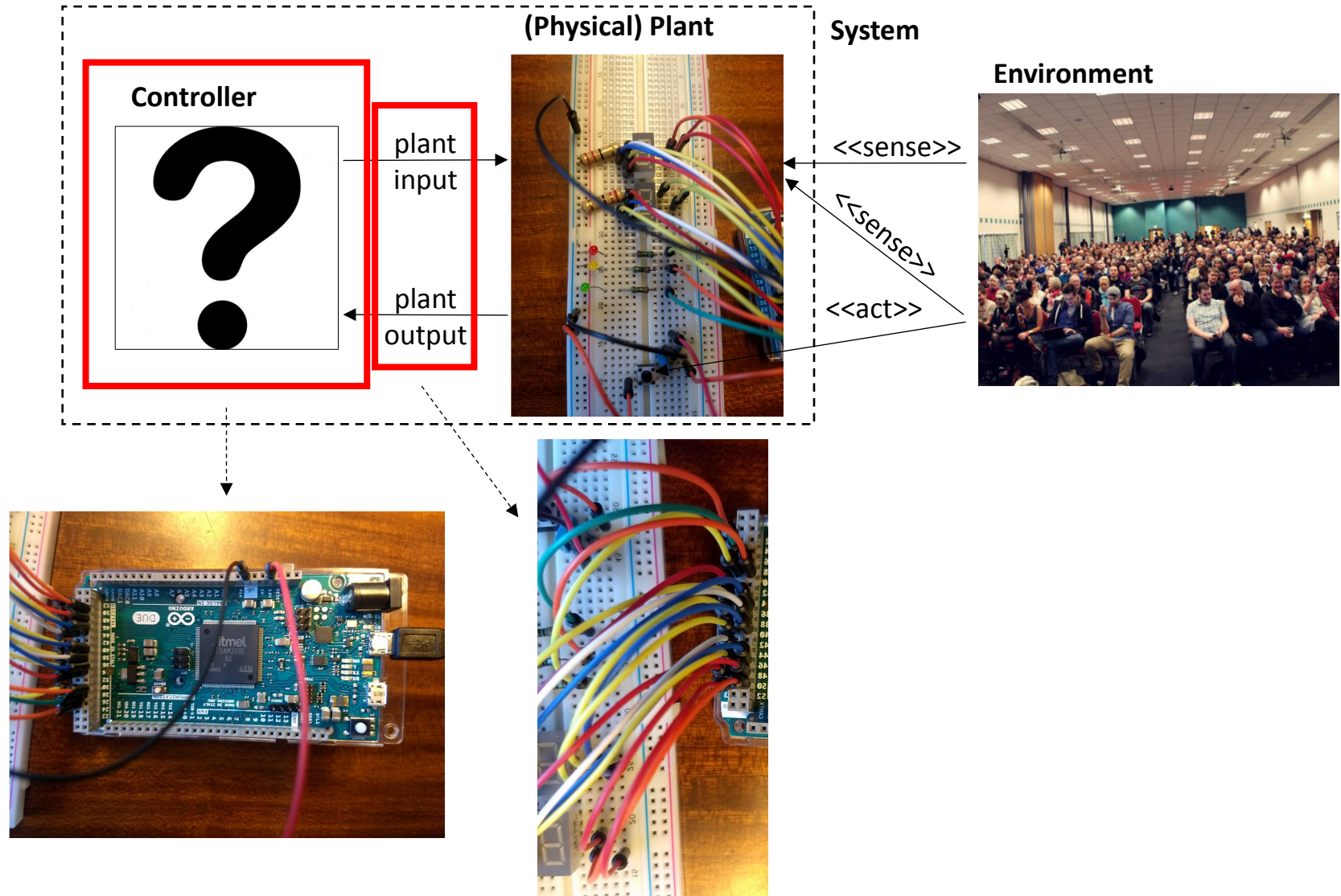

Workflow

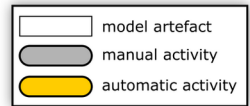
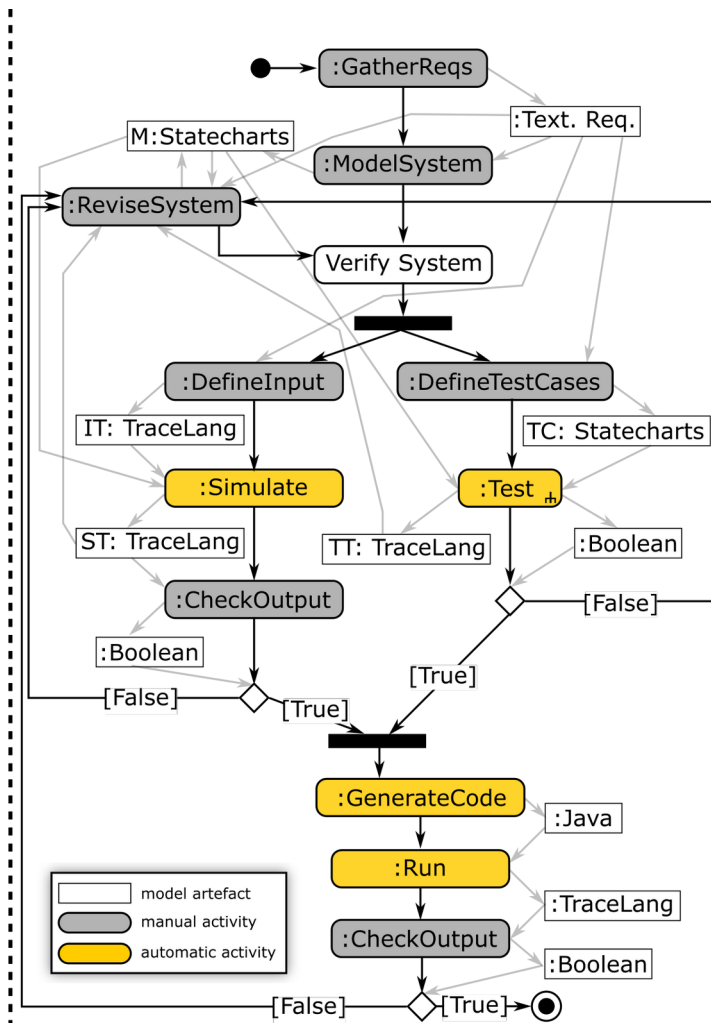
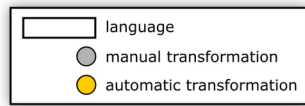
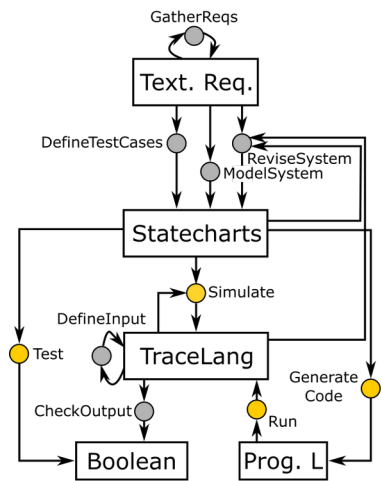

Hans Vangheluwe and Ghislain C. Vansteenkiste. A multi-paradigm modeling and simulation methodology: Formalisms and languages. In European Simulation Symposium (ESS), pages 168-172. Society for Computer Simulation International (SCS), October 1996. Genoa, Italy.

Levi Lúcio, Sadaf Mustafiz, Joachim Denil, Hans Vangheluwe, Maris Jukss. FTG+PM: An Integrated Framework for Investigating Model Transformation Chains. System Design Languages Forum (SDL) 2013, Montreal, Quebec. LNCS Volume 7916, pp 182-202, 2013.

Workflow

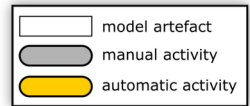
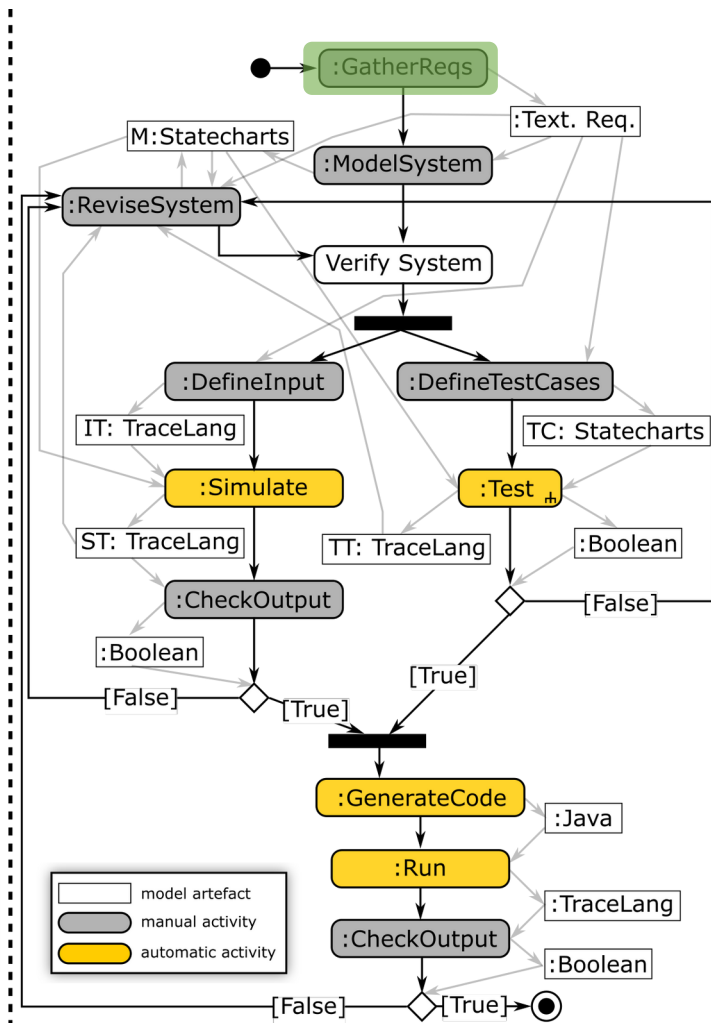
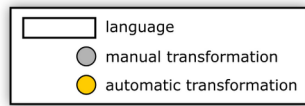
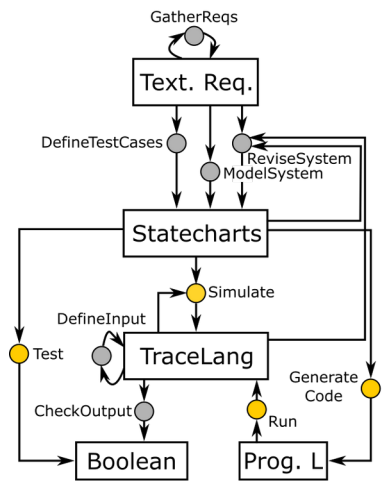

Hans Vangheluwe and Ghislain C. Vansteenkiste. A multi-paradigm modeling and simulation methodology: Formalisms and languages. In European Simulation Symposium (ESS), pages 168-172. Society for Computer Simulation International (SCS), October 1996. Genoa, Italy.

Levi Lúcio, Sadaf Mustafiz, Joachim Denil, Hans Vangheluwe, Maris Jukss. FTG+PM: An Integrated Framework for Investigating Model Transformation Chains. System Design Languages Forum (SDL) 2013, Montreal, Quebec. LNCS Volume 7916, pp 182-202, 2013.

Requirements

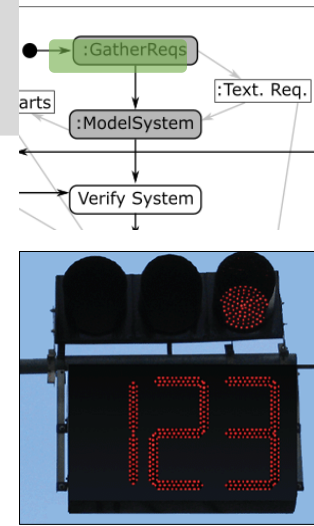

Requirements

- R1: three differently coloured lights: red, green, yellow

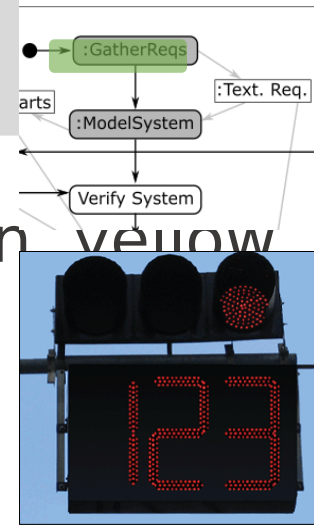

Requirements

- R1: three differently coloured lights: red, green and yellow
- R2: at most one light is on at any point in time

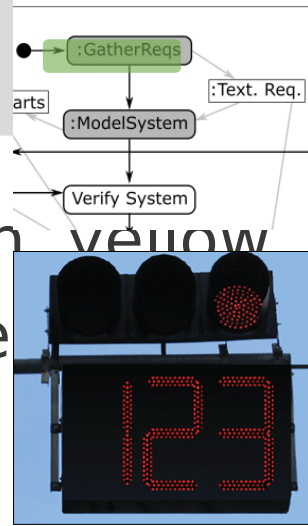

Requirements

- R1: three differently coloured lights: red, green and yellow
- R2: at most one light is on at any point in time
- R3: at system start-up, the red light is on

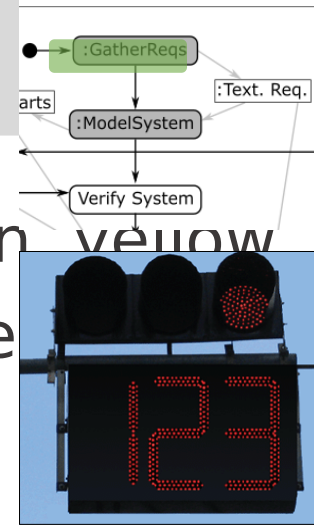

Requirements

- R1: three differently coloured lights: red, green and yellow
- R2: at most one light is on at any point in time
- R3: at system start-up, the red light is on
- R4: cycles through red on, green on, and yellow on

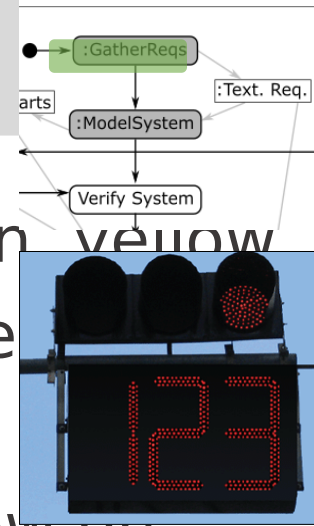

Requirements

- R1: three differently coloured lights: red, green and yellow
- R2: at most one light is on at any point in time
- R3: at system start-up, the red light is on
- R4: cycles through red on, green on, and yellow on
- R5: red is on for 60s, green is on for 55s, yellow is on for 5s

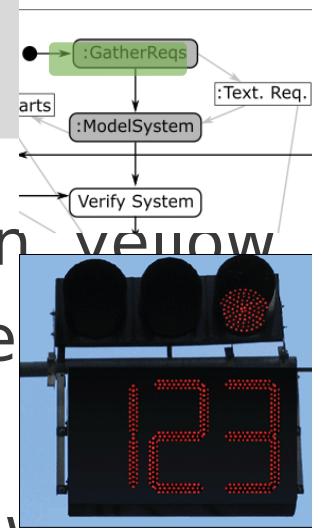

Requirements

- R1: three differently coloured lights: red, green and yellow
- R2: at most one light is on at any point in time
- R3: at system start-up, the red light is on
- R4: cycles through red on, green on, and yellow on
- R5: red is on for 60s, green is on for 55s, yellow is on for 5s
- R6: time periods of different phases are configurable.

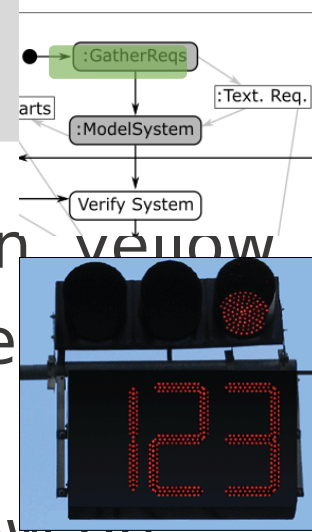

Requirements

- R1: three differently coloured lights: red, green and yellow
- R2: at most one light is on at any point in time
- R3: at system start-up, the red light is on
- R4: cycles through red on, green on, and yellow on
- R5: red is on for 60s, green is on for 55s, yellow is on for 5s
- R6: time periods of different phases are configurable.
- R7: police can interrupt autonomous operation

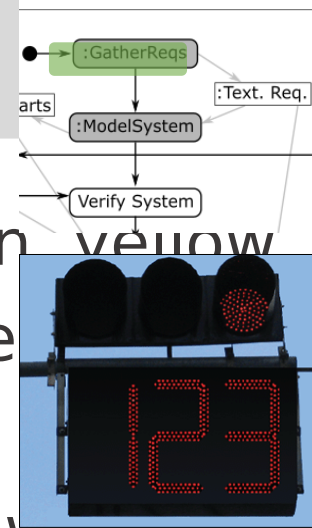

Requirements

- R1: three differently coloured lights: red, green and yellow
- R2: at most one light is on at any point in time
- R3: at system start-up, the red light is on
- R4: cycles through red on, green on, and yellow on
- R5: red is on for 60s, green is on for 55s, yellow is on for 5s
- R6: time periods of different phases are configurable.
- R7: police can interrupt autonomous operation
 - Result = blinking yellow light (on -> 1s, off -> 1s)

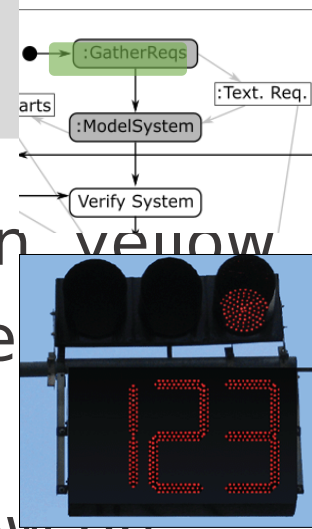

Requirements

- R1: three differently coloured lights: red, green and yellow
- R2: at most one light is on at any point in time
- R3: at system start-up, the red light is on
- R4: cycles through red on, green on, and yellow on
- R5: red is on for 60s, green is on for 55s, yellow is on for 5s
- R6: time periods of different phases are configurable.
- R7: police can interrupt autonomous operation
 - Result = blinking yellow light (on -> 1s, off -> 1s)
- R8: police can resume an interrupted traffic light

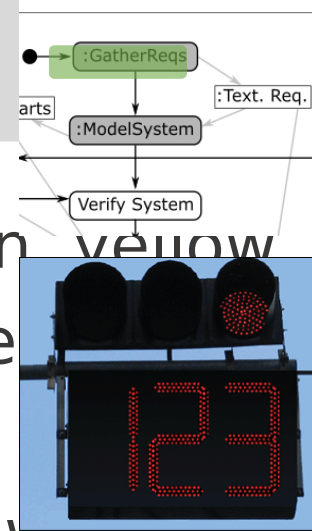

Requirements

- R1: three differently coloured lights: red, green and yellow
- R2: at most one light is on at any point in time
- R3: at system start-up, the red light is on
- R4: cycles through red on, green on, and yellow on
- R5: red is on for 60s, green is on for 55s, yellow is on for 5s
- R6: time periods of different phases are configurable.
- R7: police can interrupt autonomous operation
 - Result = blinking yellow light (on -> 1s, off -> 1s)
- R8: police can resume an interrupted traffic light
 - Result = light which was on at time of interrupt is turned on again

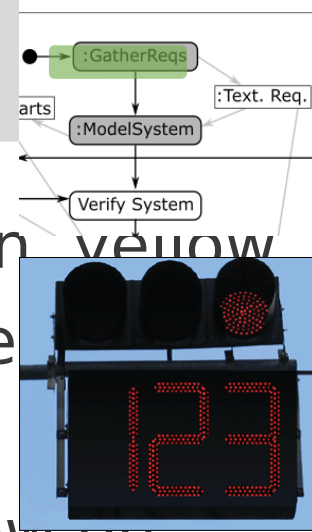

Requirements

- R1: three differently coloured lights: red, green, yellow
- R2: at most one light is on at any point in time
- R3: at system start-up, the red light is on
- R4: cycles through red on, green on, and yellow on
- R5: red is on for 60s, green is on for 55s, yellow is on for 5s
- R6: time periods of different phases are configurable.
- R7: police can interrupt autonomous operation
 - Result = blinking yellow light (on -> 1s, off -> 1s)
- R8: police can resume an interrupted traffic light
 - Result = light which was on at time of interrupt is turned on again
- R9: traffic light can be switched on and off and restores its state

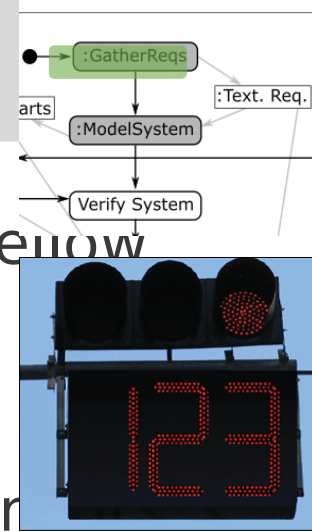

Requirements

- R1: three differently coloured lights: red, green, yellow
- R2: at most one light is on at any point in time
- R3: at system start-up, the red light is on
- R4: cycles through red on, green on, and yellow on
- R5: red is on for 60s, green is on for 55s, yellow is on for 5s
- R6: time periods of different phases are configurable.
- R7: police can interrupt autonomous operation
 - Result = blinking yellow light (on -> 1s, off -> 1s)
- R8: police can resume an interrupted traffic light
 - Result = light which was on at time of interrupt is turned on again
- R9: traffic light can be switched on and off and restores its state
- R10: a timer displays the remaining time while the light is red or green; this timer decreases and displays its value every second. The colour of the timer reflects the colour of the traffic light.

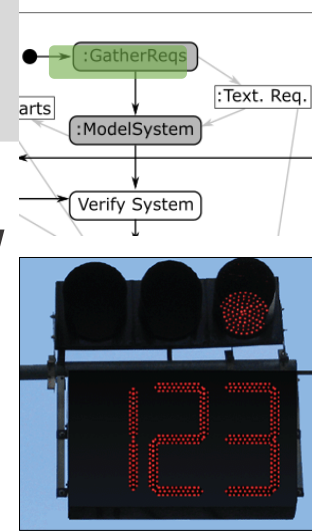



YAKINDU Statechart Tools

Statecharts made easy...



What are YAKINDU Statechart Tools?

YAKINDU Statechart Tools provides an **integrated modeling environment** for the specification and development of **reactive, event-driven systems** based on the concept of statecharts.

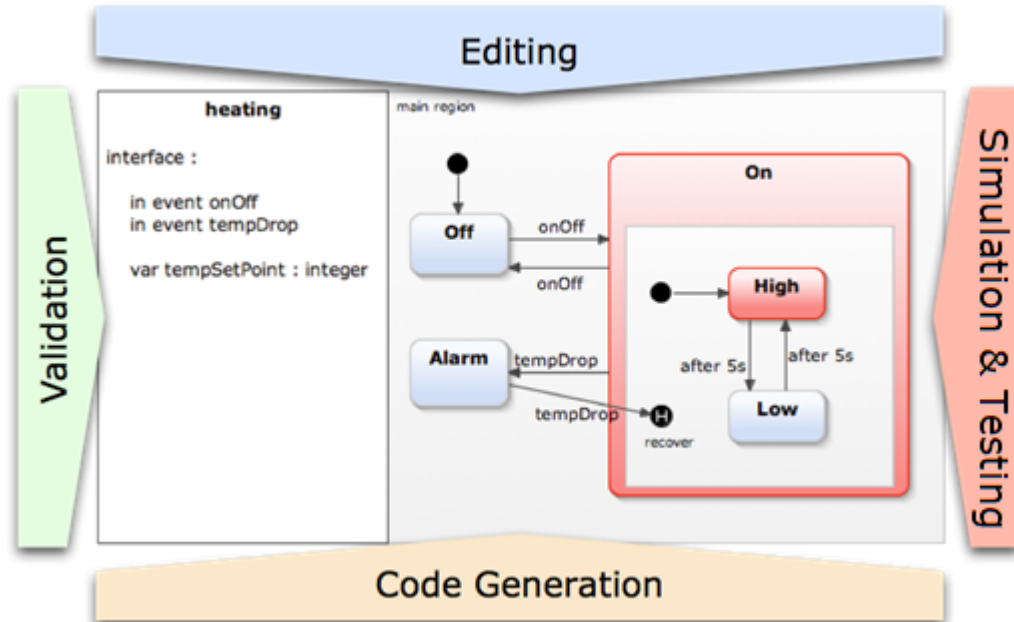

The Statecharts Language

States



being **in** a state
= state <<*name*>> is
active
= the system is in
configuration <<*name*>>

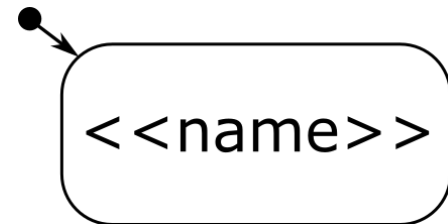

initial state
exactly one per
model
“entry point”

Transitions

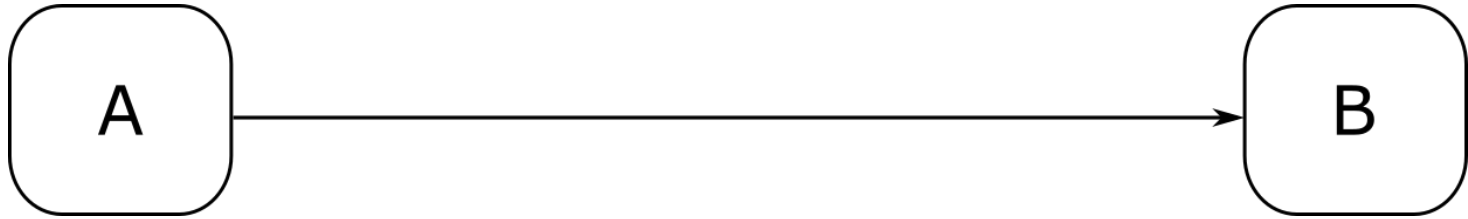

- Model the **dynamics** of the system:

Transitions

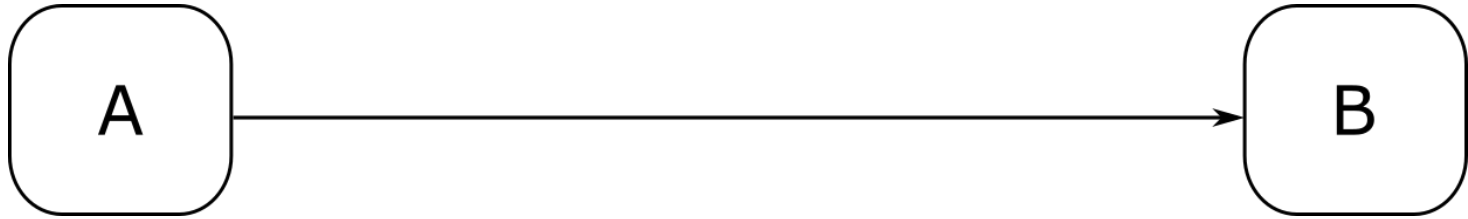

- Model the **dynamics** of the system:
 - *if*

Transitions

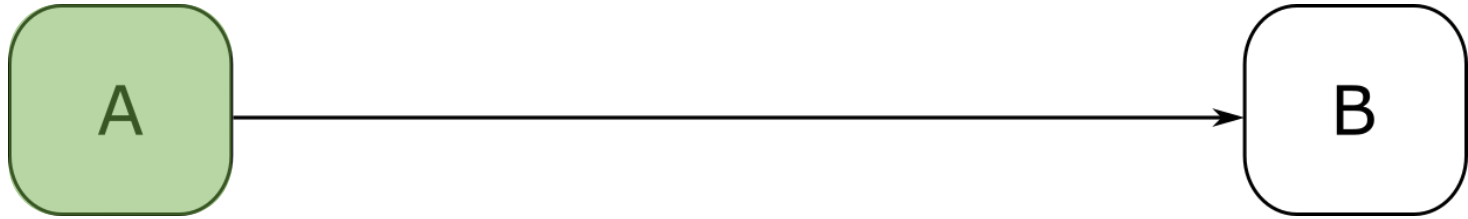

- Model the **dynamics** of the system:
 - *if*
 - the system is **in state A**

Transitions

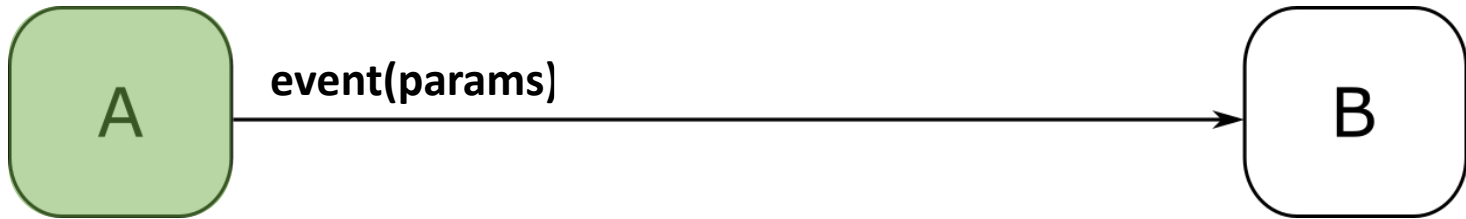

- Model the **dynamics** of the system:
 - *if*
 - the system is **in state A**
 - and **event** is **processed**

Transitions

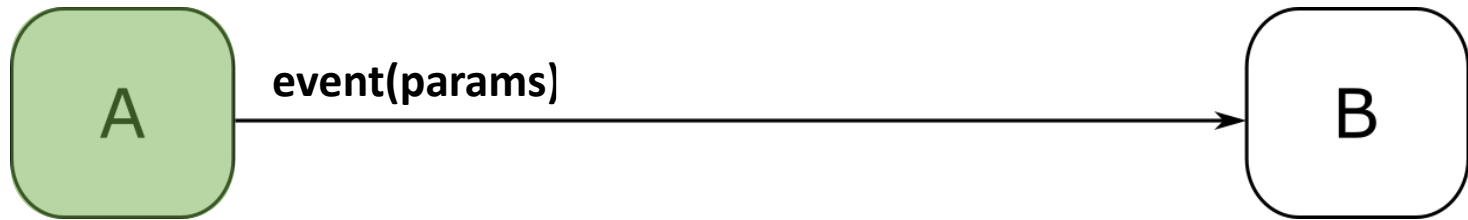

- Model the **dynamics** of the system:
 - *if*
 - the system is **in state A**
 - and **event** is **processed**
 - *then*

Transitions

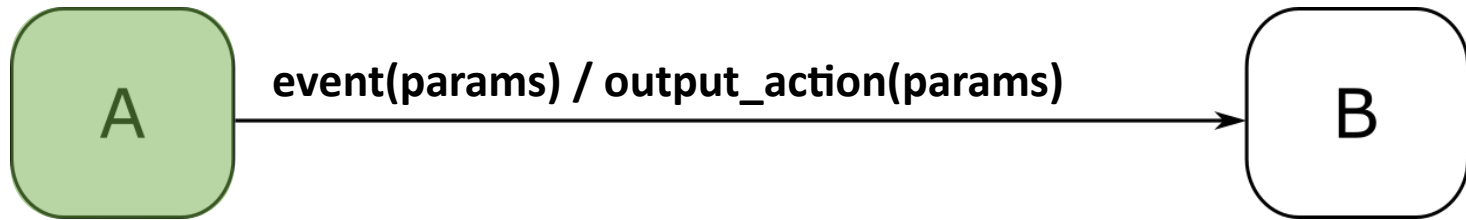

- Model the **dynamics** of the system:
 - *if*
 - the system is **in state A**
 - and **event** is **processed**
 - *then*
 1. **output_action** is evaluated

Transitions

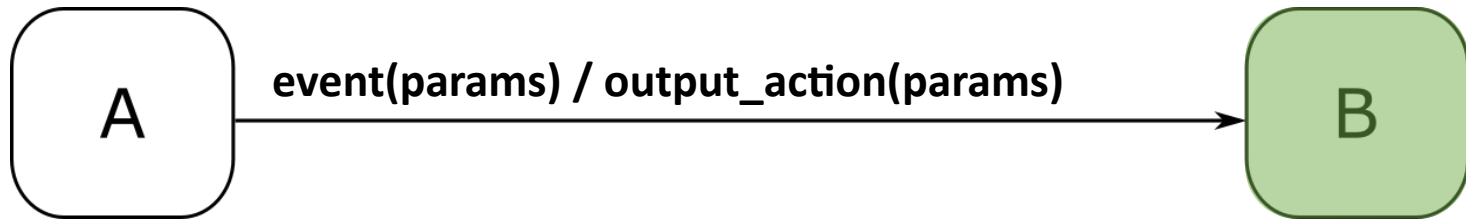

- Model the **dynamics** of the system:
 - *if*
 - the system is **in state A**
 - and **event** is **processed**
 - *then*
 1. **output_action** is evaluated
 2. and the new **active state** is B

Transitions: Events

event(in_params) / output_action(out_params)

Transitions: Events

`event(in_params) / output_action(out_params)`

- Spontaneous

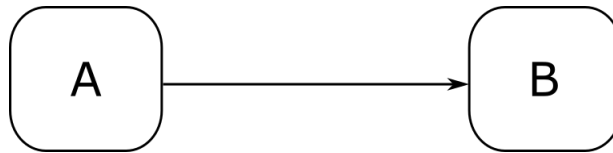

Transitions: Events

`event(in_params) / output_action(out_params)`

- Spontaneous

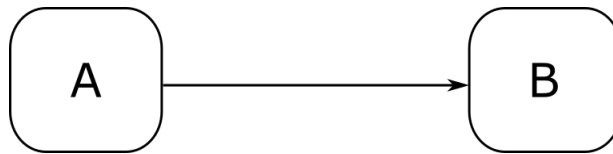

- Input Event

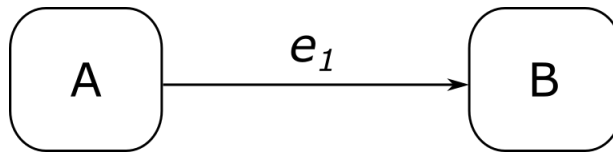

Transitions: Events

`event(in_params) / output_action(out_params)`

- Spontaneous

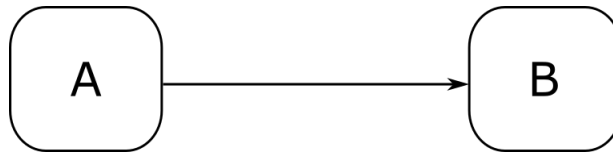

- Input Event

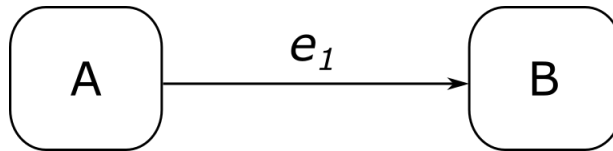

queue of event notices

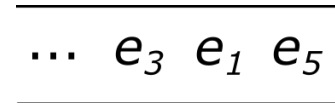

processing

An upward-pointing arrow originates from the word "processing" and points to the event notice e_1 in the queue above.

Transitions: Events

`event(in_params) / output_action(out_params)`

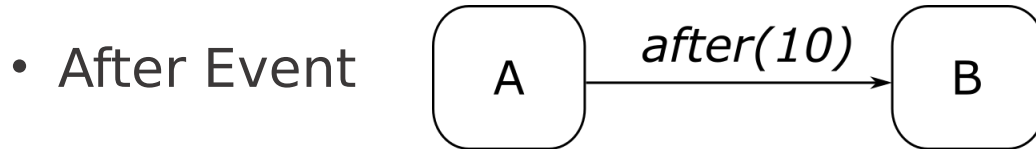
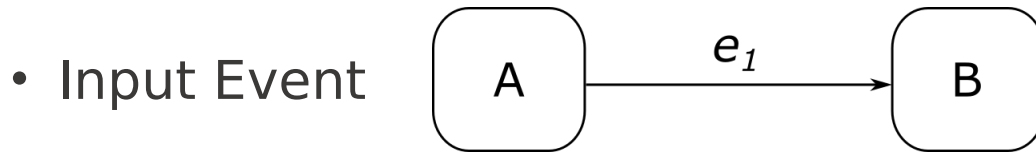
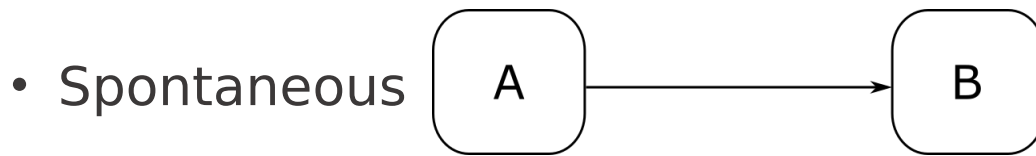

queue of event notices

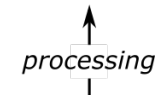
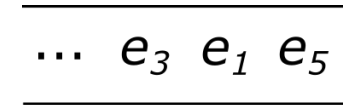

Transitions: Events

event(in_params) / output_action(out_params)

- Spontaneous

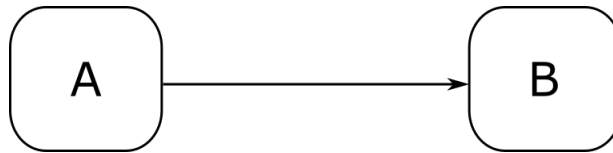

- Input Event

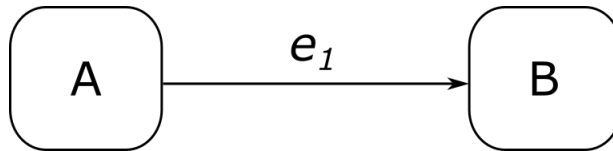

queue of event notices

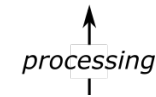
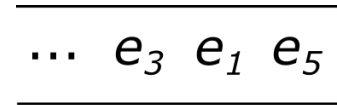

- After Event

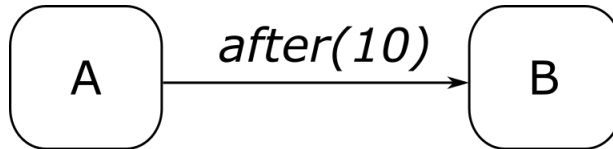

queue of event notices

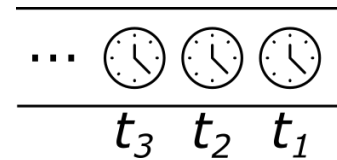
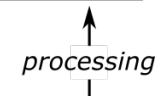

Transitions: Events

event(in_params) / output_action(out_params)

- Spontaneous

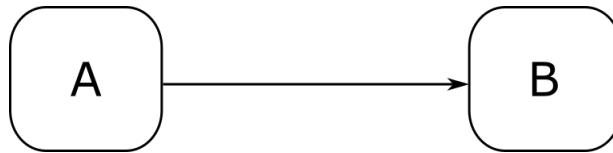

- Input Event

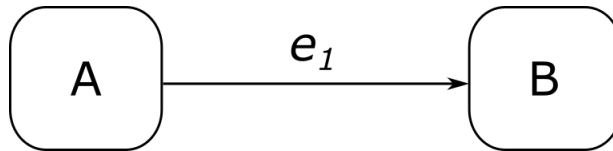

- After Event

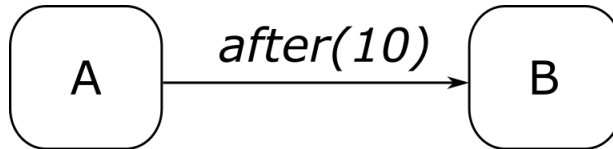

queue of event notices

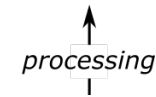
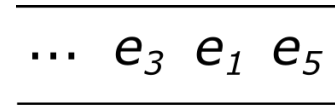

queue of event notices

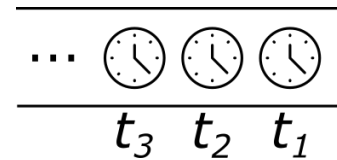
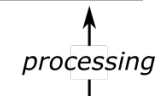

<<when triggered>>:

Transitions: Events

event(in_params) / output_action(out_params)

- Spontaneous

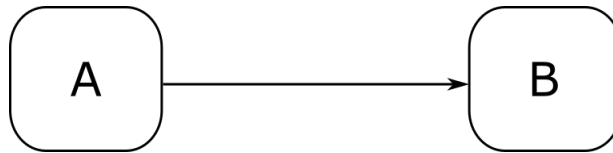

- Input Event

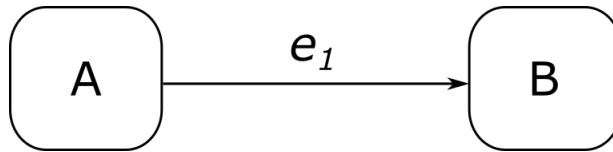

- After Event

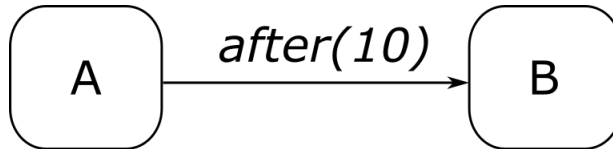

queue of event notices

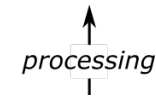
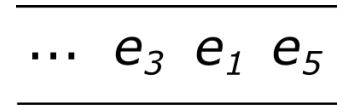

queue of event notices

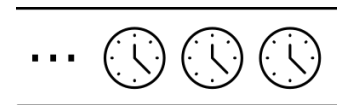
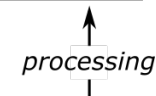
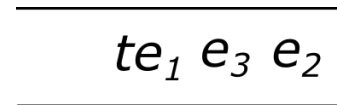

<<when triggered>>: <<insert event>>

Transitions: Events

event(in_params) / output_action(out_params)

- Spontaneous

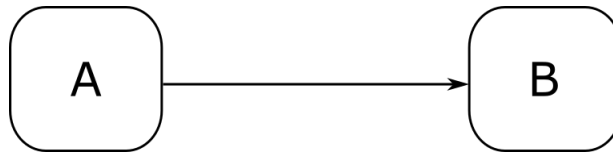

- Input Event

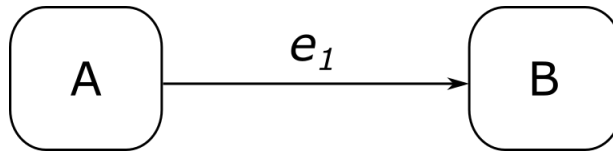

- After Event

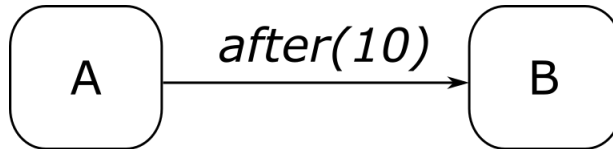

queue of event notices

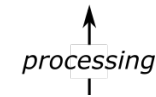
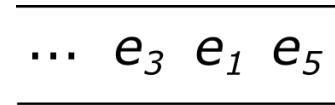

queue of event notices

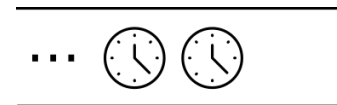
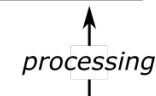
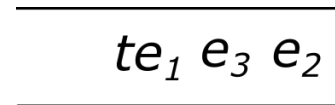

<<when triggered>>: <<insert event>>
<<remove timer>>

Transitions: Raising Output Events

`event(in_params) / output_action(out_params)`

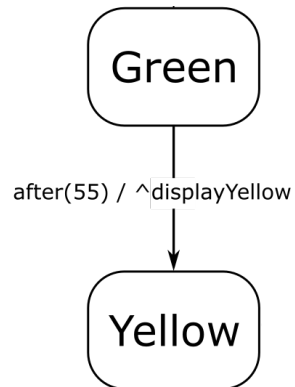

Syntax for output action:

^output_event

means “raise the event *output_event* (to the environment)”

Exercise 1 - Requirements

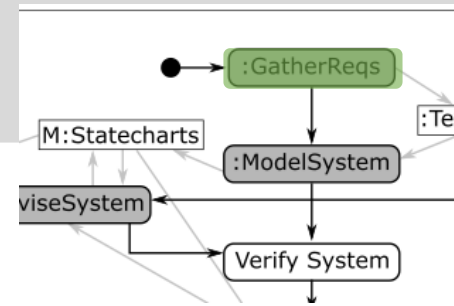

Your model here.

- R1: three differently coloured lights: red (R), green (G), yellow (Y)
- R2: at most one light is on at any point in time
- R3: at system start-up, the red light is on
- R4: cycles through red on, green on, and yellow on
- R5: red is on for 60s, green is on for 55s, yellow is on for 5s

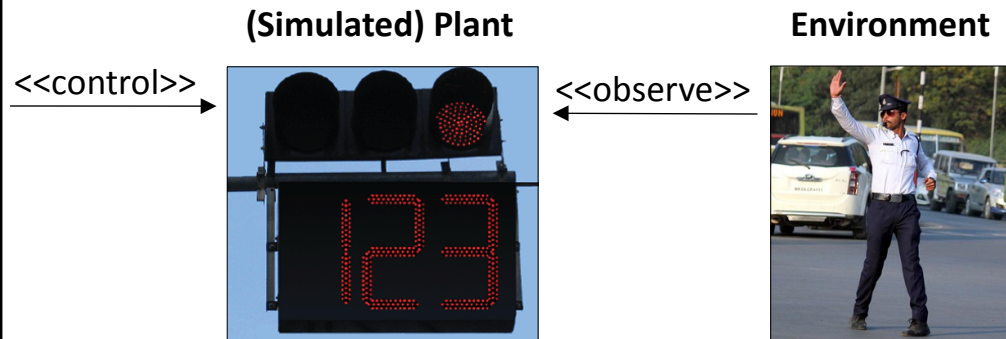

Exercise 1 - Solution

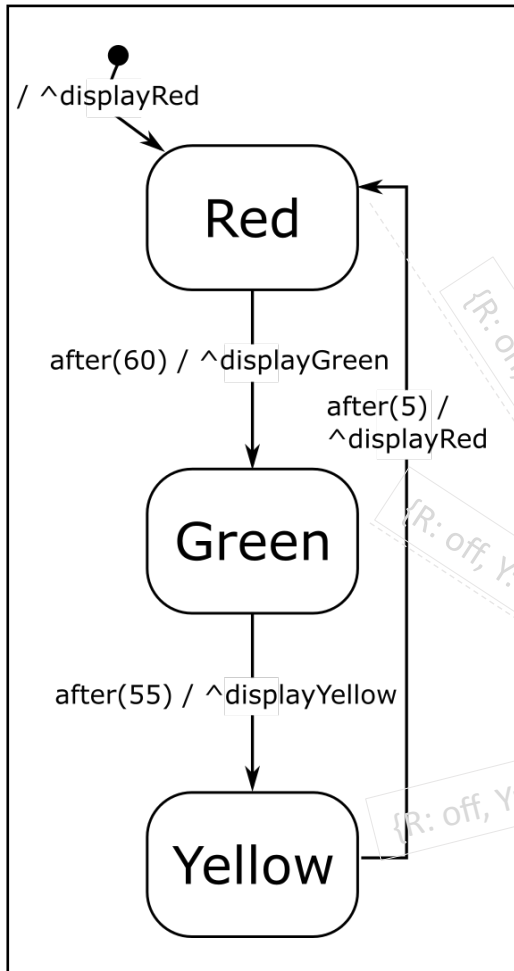
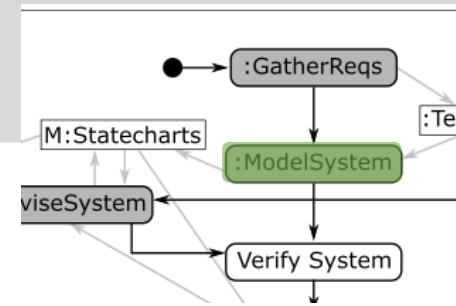

- R1: three differently coloured **lights**: red (R), green (G), yellow (Y)
- R2: at most one light is on at any point in time
- R3: at system start-up, the **red** light is on
- R4: cycles through red on, green on, and yellow on
- R5: **red** is on for 60s, **green** is on for 55s, **yellow** is on for 5s

{R: on, Y: off, G: on}

{R: off, Y: off, G: on}

{R: off, Y: on, G: off}

(Simulated) Plant



Environment



<<observe>>



Exercise 1 - Solution

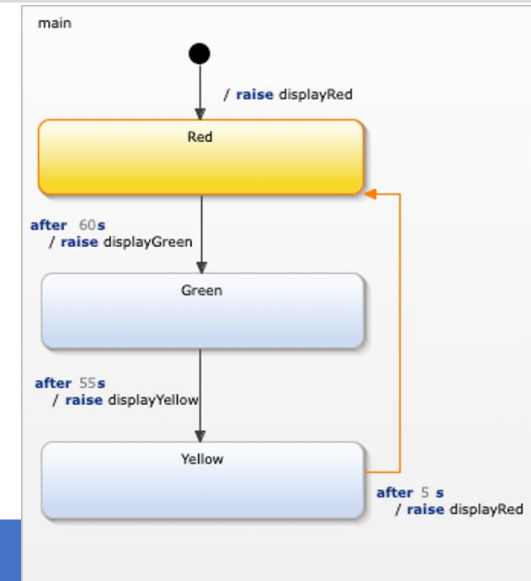

requirement

modelling approach

R1: three differently coloured **lights**: red (R), green (G), yellow (Y)

For each colour a **state** is defined. Transitions that lead to a state raise the proper out event which interacts with the plant.

R2: at most one light is on at any point in time

The states are all contained in a single region and thus are exclusive to each other (“or” states).

R3: at system start-up, the red light is on

The entry node points to state Red and the entry transition raises the event displayRed.

R4: cycles through red on, green on, and yellow on

The transitions define this cycle.

R5: red is on for 60s, green is on for 55s, yellow is on for 5s

Time events are specified on the transitions.

Data Store

Full System State

<<name>>

being **in** a state

= state <<*name*>> is
active

= the system is in
configuration <<*name*>>

Full System State

<<name>>

+

DataStore
- var ₁ : t ₁ = val ₁
- var ₂ : t ₂ = val ₂
...
- var _n : t _n = val _n

being **in** a state
= state <<*name*>> is
active
= the system is in
configuration <<*name*>>

data store **snapshot**
= variable values

Full System State

<<name>>

+

DataStore
- var ₁ : t ₁ = val ₁
- var ₂ : t ₂ = val ₂
...
- var _n : t _n = val _n

being **in** a state
= state <<*name*>> is
active
= the system is in
configuration <<*name*>>

data store **snapshot**
= variable values

=

full system state

Full System State: Initialization

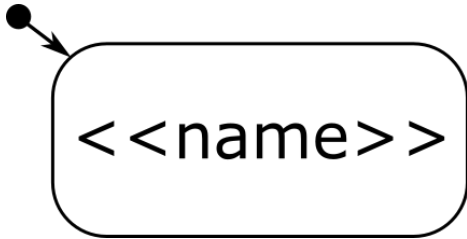

initial state
exactly one per
model
“entry point”

Full System State: Initialization

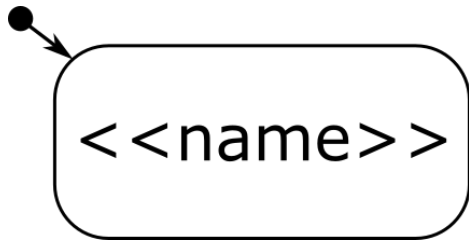

DataStore
- var ₁ : t ₁ = val ₁
- var ₂ : t ₂ = val ₂
...
- var _n : t _n = val _n

initial state
exactly one per
model
“entry point”

provide **default
value** for each
variable
“initial snapshot”

Full System State: Initialization

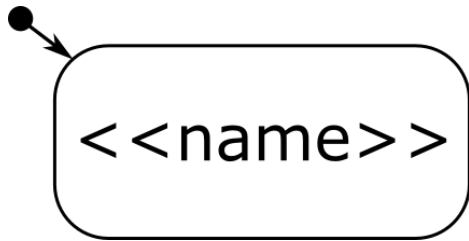

DataStore
- var ₁ : t ₁ = val ₁
- var ₂ : t ₂ = val ₂
...
- var _n : t _n = val _n

```
1 int main() {  
2  
3 }
```

initial state
exactly one per
model
“entry point”

provide **default
value** for each
variable
“initial snapshot”

Compare:
C++ initialization
implicit state
(program counter)
+ **data store**

Transitions: Guards

event(in_params) [guard] / output_action(out_params)

Modelled by “guard expression” (evaluates to Boolean) in some appropriate language

Transitions: Guards

`event(in_params) [guard] / output_action(out_params)`

Modelled by “guard expression” (evaluates to Boolean) in some appropriate language

- Spontaneous [True]

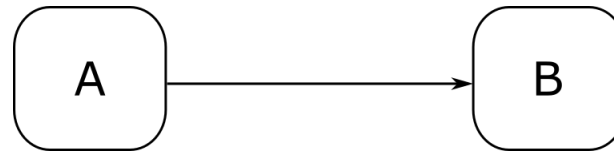

Transitions: Guards

`event(in_params) [guard] / output_action(out_params)`

Modelled by “guard expression” (evaluates to Boolean) in some appropriate language

- Spontaneous [True]

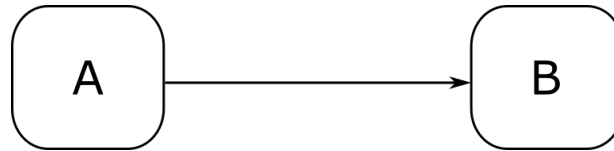

- Data Store
Variable Value

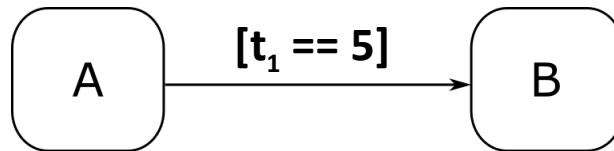

DataStore
- var ₁ : t ₁ = val ₁
- var ₂ : t ₂ = val ₂
...
- var _n : t _n = val _n

Transitions: Guards

`event(in_params) [guard] / output_action(out_params)`

Modelled by “guard expression” (evaluates to Boolean) in some appropriate language

- Spontaneous [True]

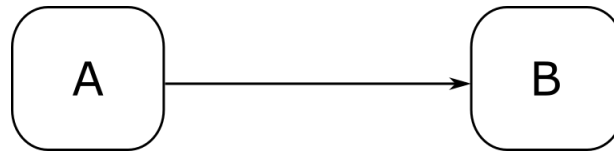

- Data Store Variable Value

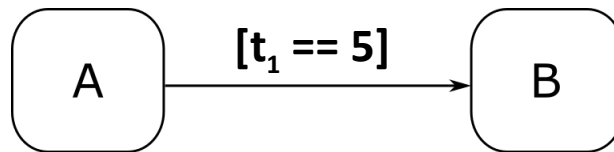

DataStore
- var ₁ : t ₁ = val ₁
- var ₂ : t ₂ = val ₂
...
- var _n : t _n = val _n

- Parameter Value

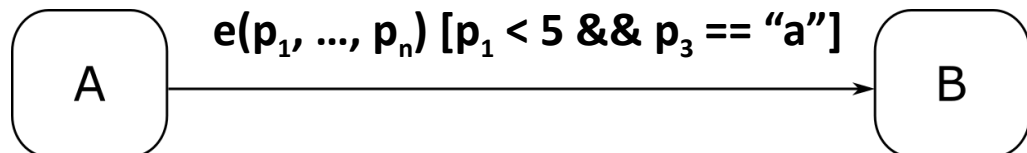

Transitions: Output Actions

event(params) [guard] / output_action(params)

Transitions: Output Actions

event(params) [guard] / output_action(params)

Output Event

$\wedge output_event(p_1, p_2, \dots, p_n)$

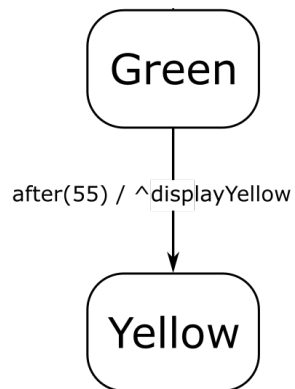

Transitions: Output Actions

`event(params) [guard] / output_action(params)`

Output Event

$\wedge output_event(p_1, p_2, \dots, p_n)$

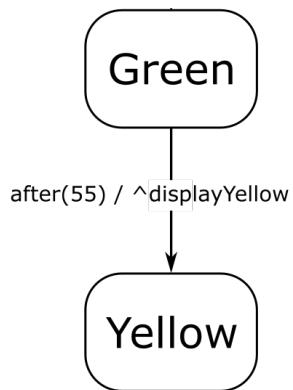

Assignment (to the non-modal part of the state)

- by action code in some appropriate language

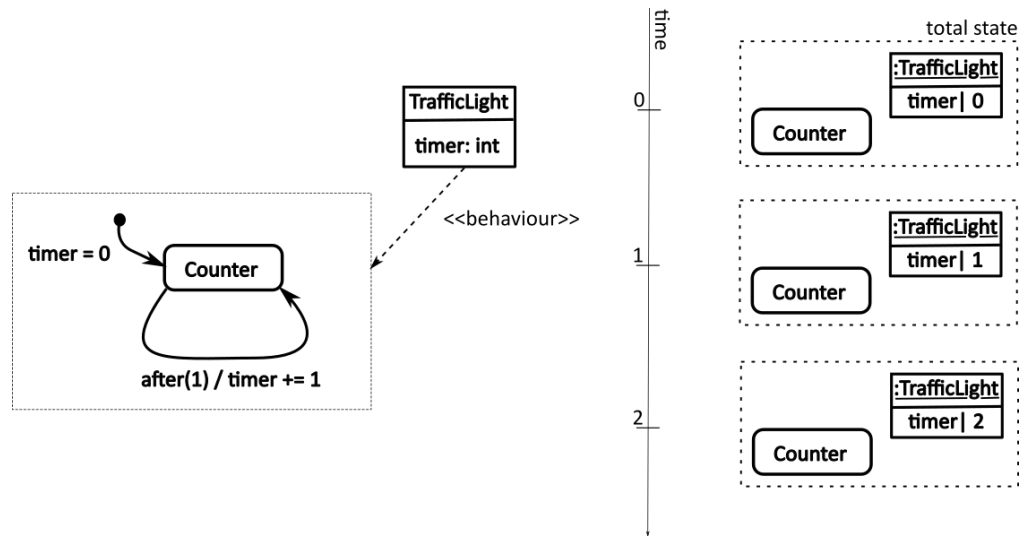

Transitions

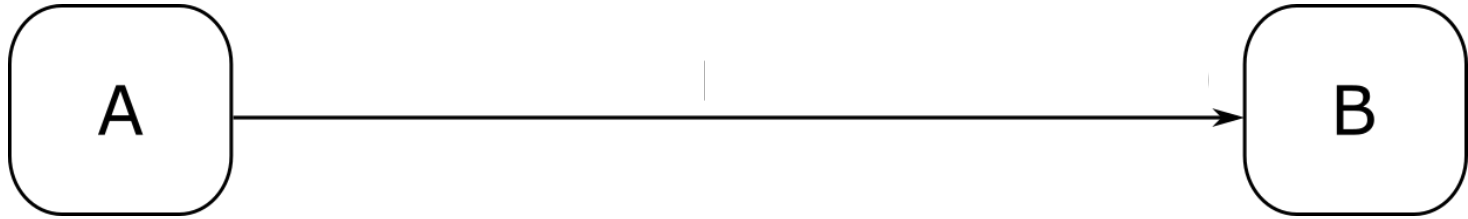

- Model the **dynamics** of the system:

Transitions

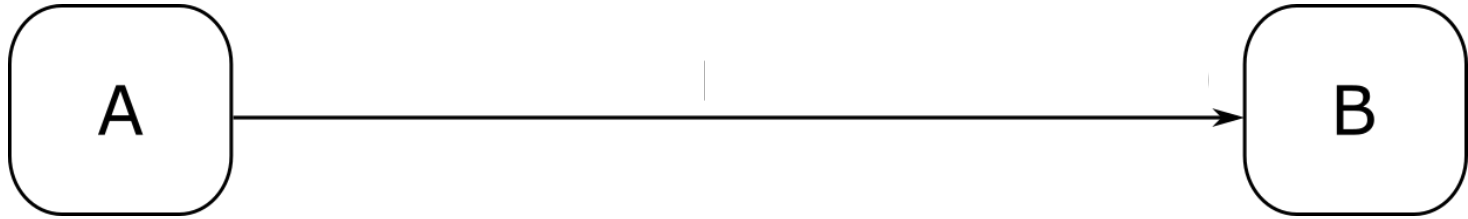

- Model the **dynamics** of the system:
 - *if*

Transitions

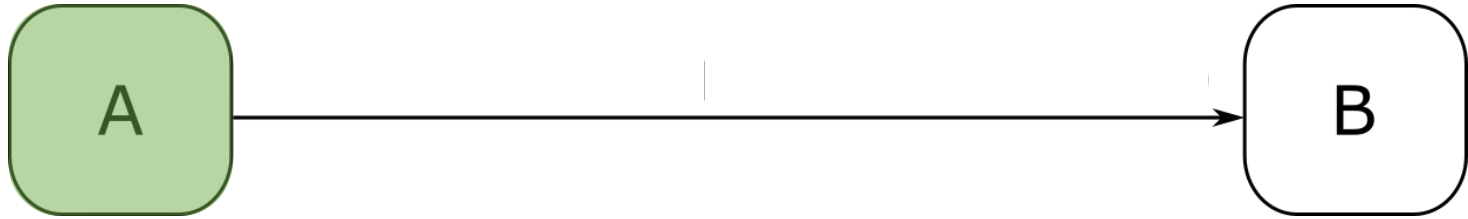

- Model the **dynamics** of the system:
 - *if*
 - the system is **in state A**

Transitions

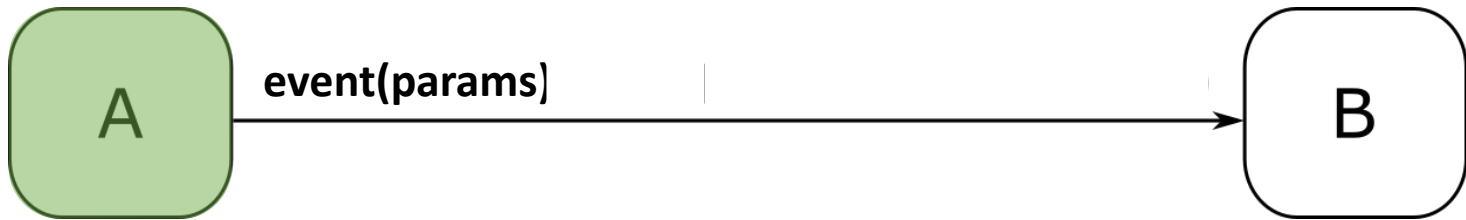

- Model the **dynamics** of the system:
 - *if*
 - the system is **in state A**
 - and **event is processed**

Transitions

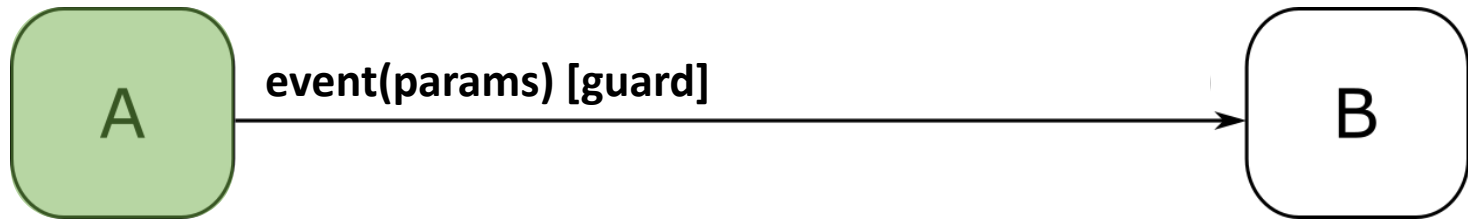

- Model the **dynamics** of the system:
 - *if*
 - the system is **in state A**
 - and **event is processed**
 - and **guard** evaluates to **True**

Transitions

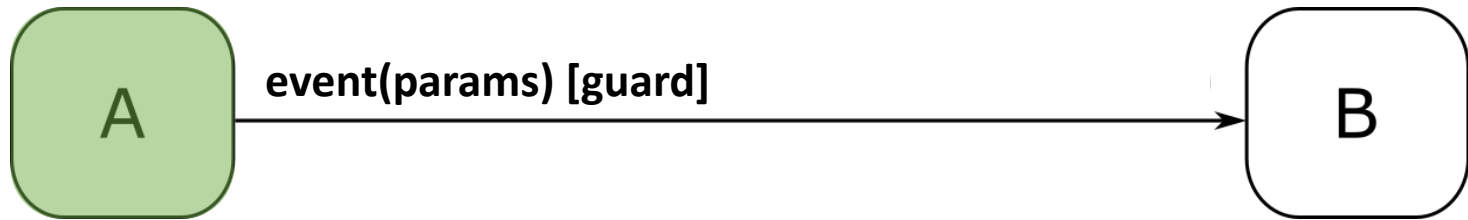

- Model the **dynamics** of the system:
 - *if*
 - the system is **in state A**
 - and **event is processed**
 - and **guard** evaluates to **True**
 - *then*

Transitions

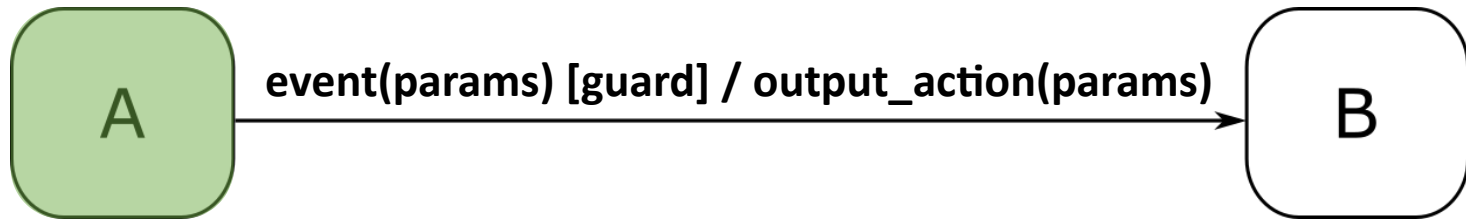

- Model the **dynamics** of the system:
 - *if*
 - the system is **in state A**
 - and **event is processed**
 - and **guard** evaluates to **True**
 - *then*
 1. **output_action** is evaluated

Transitions

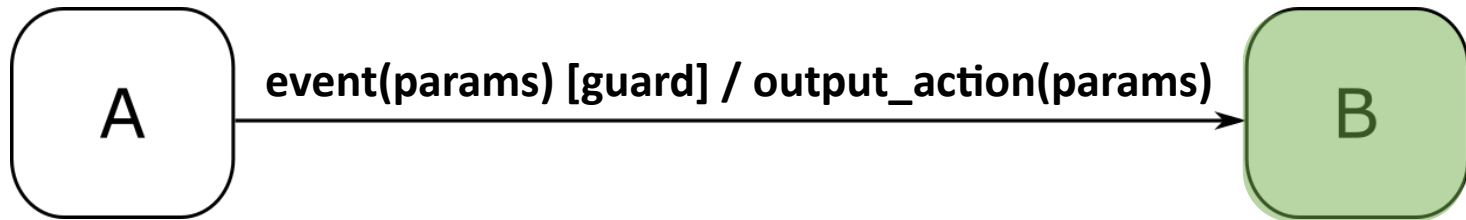

- Model the **dynamics** of the system:
 - *if*
 - the system is **in state A**
 - and **event is processed**
 - and **guard** evaluates to **True**
 - *then*
 1. **output_action** is evaluated
 2. and the new **active state** is B

Exercise 2

Add data stores

Exercise 2 - Requirements

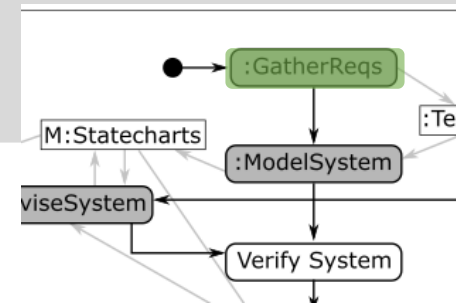

Your model here.

- R6': During the last 6 seconds of red being on, the traffic light announces to go to green by blinking its yellow light (1s on, 1s off) while leaving its red light on.
- R6: The time period of the different phases should be configurable.

TrafficLight

- counter: Integer = 0
- green: Boolean = false
- red: Boolean = false
- yellow: Boolean = false



Exercise 2 - Requirements

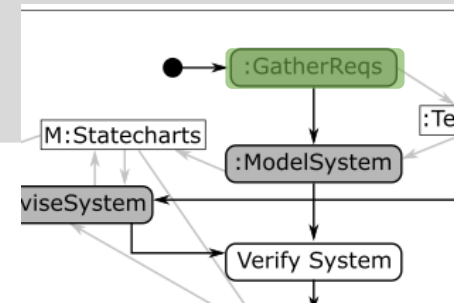

Your model here.

- R6': During the last 6 seconds of red being on, the traffic light announces to go to green by blinking its yellow light (1s on, 1s off) while leaving its red light on.
- R6: The time period of the different phases should be configurable.

TrafficLight

- counter: Integer = 0
- green: Boolean = false
- red: Boolean = false
- yellow: Boolean = false

Make sure that:

- **the values of the variables reflect which lights are on/off**
- **you use at least one conditional transition**

<<behavior>>

Exercise 2: Solution

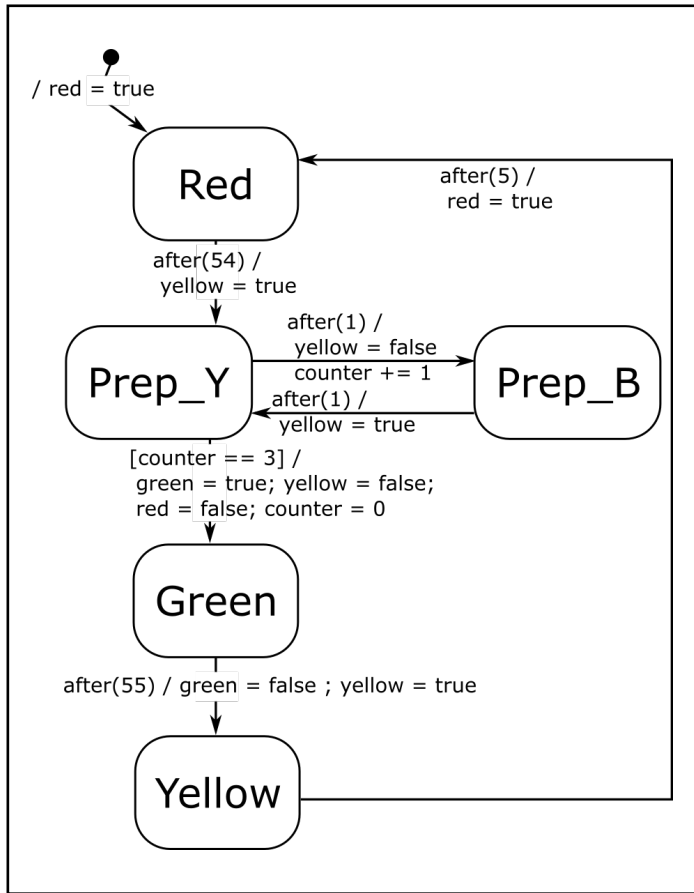
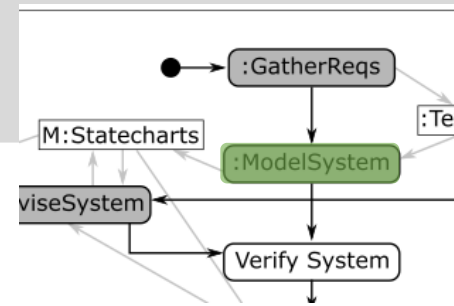

- R6': During the last 6 seconds of red being on, the traffic light announces to go to green by blinking its yellow light (1s on, 1s off) while leaving its red light on.
- R6: The time period of the different phases should be configurable.

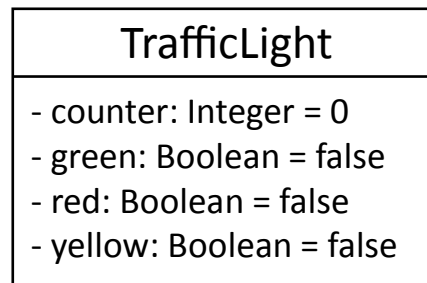

Exercise 2: Solution

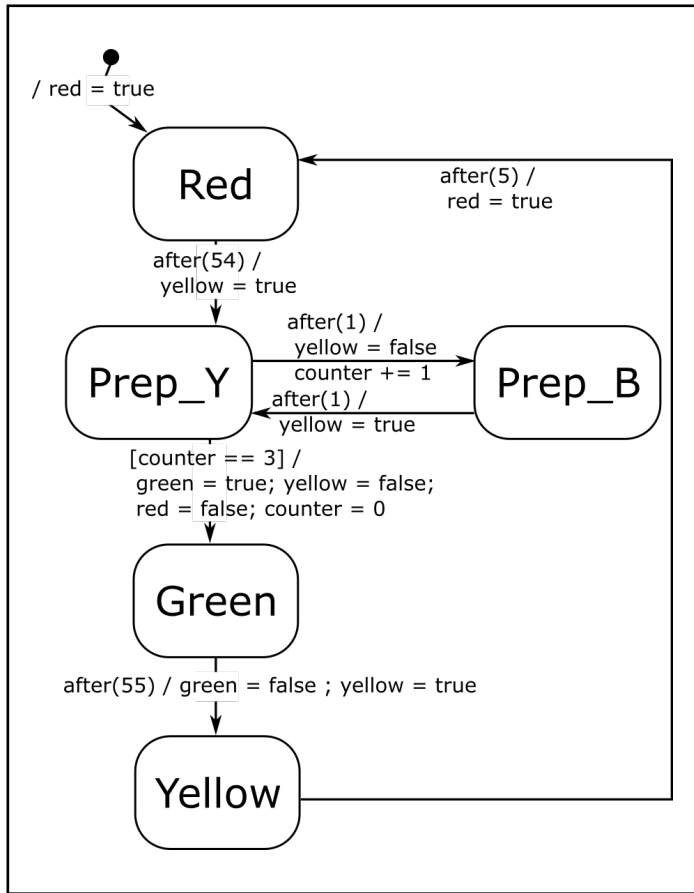
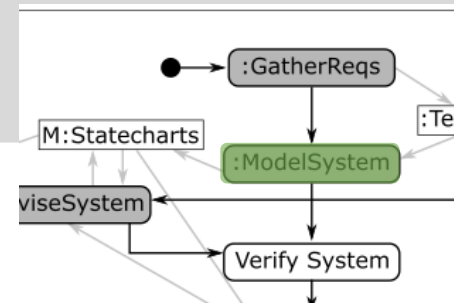

- R6': During the last 6 seconds of red being on, the traffic light announces to go to green by blinking its yellow light (1s on, 1s off) while leaving its red light on.
- R6: The time period of the different phases should be configurable.

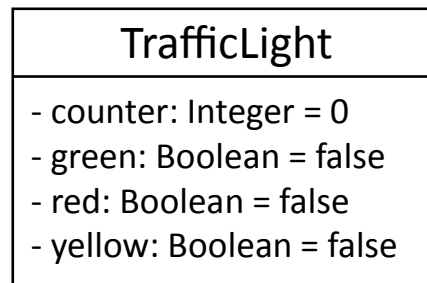

<<behavior>>

Statechart Execution

Run-To-Completion Step

- A Run-To-Completion (RTC) step is an *atomic execution step* of a state machine.
- It transitions the state machine from a *valid state configuration* into the next *valid state configuration*.
- RTC steps are executed one after the other - they must *not interleave*.
- New incoming events *cannot interrupt* the processing of the current event and must be stored in an *event queue*

Flat Statecharts: Simulation Algorithm (1)

```
1 simulate(sc: Statechart) {
```

```
18 }
```

Flat Statecharts: Simulation Algorithm (1)

```
1 simulate(sc: Statechart) {  
2     input_events = initialize_queue()  
3     output_events = initialize_queue()  
4     timers      = initialize_set()  
5     curr_state  = sc.initial_state  
6     for (var in sc.variables) {  
7         var.value = var.initial_value  
8     }
```

Flat Statecharts: Simulation Algorithm (1)

```
1 simulate(sc: Statechart) {  
2     input_events = initialize_queue()  
3     output_events = initialize_queue()  
4     timers = initialize_set()  
5     curr_state = sc.initial_state  
6     for (var in sc.variables) {  
7         var.value = var.initial_value  
8     }  
9     while (not finished()) {
```

```
17     }  
18 }
```

Flat Statecharts: Simulation Algorithm (1)

```
1  simulate(sc: Statechart) {
2      input_events = initialize_queue()
3      output_events = initialize_queue()
4      timers = initialize_set()
5      curr_state = sc.initial_state
6      for (var in sc.variables) {
7          var.value = var.initial_value
8      }
9      while (not finished()) {
10         curr_event = input_events.get()
11         enabled_transitions = find_enabled_transitions(curr_state, curr_event, sc.variables)
12
13
14
15
16     }
17 }
18 }
```

Flat Statecharts: Simulation Algorithm (1)

```
1 simulate(sc: Statechart) {
2     input_events = initialize_queue()
3     output_events = initialize_queue()
4     timers = initialize_set()
5     curr_state = sc.initial_state
6     for (var in sc.variables) {
7         var.value = var.initial_value
8     }
9     while (not finished()) {
10        curr_event = input_events.get()
11        enabled_transitions = find_enabled_transitions(curr_state, curr_event, sc.variables)
12        chosen_transition = choose_one_transition(enabled_transitions)
17    }
18 }
```

Flat Statecharts: Simulation Algorithm (1)

```
1 simulate(sc: Statechart) {
2     input_events = initialize_queue()
3     output_events = initialize_queue()
4     timers = initialize_set()
5     curr_state = sc.initial_state
6     for (var in sc.variables) {
7         var.value = var.initial_value
8     }
9     while (not finished()) {
10        curr_event = input_events.get()
11        enabled_transitions = find_enabled_transitions(curr_state, curr_event, sc.variables)
12        chosen_transition = choose_one_transition(enabled_transitions)
14        curr_state = chosen_transition.target
17    }
18 }
```

Flat Statecharts: Simulation Algorithm (1)

```
1 simulate(sc: Statechart) {
2     input_events = initialize_queue()
3     output_events = initialize_queue()
4     timers = initialize_set()
5     curr_state = sc.initial_state
6     for (var in sc.variables) {
7         var.value = var.initial_value
8     }
9     while (not finished()) {
10        curr_event = input_events.get()
11        enabled_transitions = find_enabled_transitions(curr_state, curr_event, sc.variables)
12        chosen_transition = choose_one_transition(enabled_transitions)
13
14        curr_state = chosen_transition.target
15        chosen_transition.action.execute(sc.variables, output_events)
16
17    }
18 }
```

Flat Statecharts: Simulation Algorithm (1)

```
1 simulate(sc: Statechart) {
2     input_events = initialize_queue()
3     output_events = initialize_queue()
4     timers = initialize_set()
5     curr_state = sc.initial_state
6     for (var in sc.variables) {
7         var.value = var.initial_value
8     }
9     while (not finished()) {
10        curr_event = input_events.get()
11        enabled_transitions = find_enabled_transitions(curr_state, curr_event, sc.variables)
12        chosen_transition = choose_one_transition(enabled_transitions)
13        cancel_timers(curr_state, timers)
14        curr_state = chosen_transition.target
15        chosen_transition.action.execute(sc.variables, output_events)
16        start_timers(curr_state, timers)
17    }
18 }
```

Flat Statecharts: Simulation Algorithm (2)

```
1 simulate(sc: Statechart) {
2     input_events = initialize_queue()
3     output_events = initialize_queue()
4     timers = initialize_set()
5     curr_state = sc.initial_state
6     for (var in sc.variables) {
7         var.value = var.initial_value
8     }
9     while (not finished()) {
10        curr_event = input_events.get()
11        while (not quiescent()) {
12            enabled_transitions = find_enabled_transitions(curr_state, curr_event, sc.variables)
13            chosen_transition = choose_one_transition(enabled_transitions)
14            cancel_timers(curr_state, timers)
15            curr_state = chosen_transition.target
16            chosen_transition.action.execute(sc.variables, output_events)
17            start_timers(curr_state, timers)
18        }
19    }
20 }
```

Flat Statecharts: Simulation Algorithm (3)

```
1  simulate(sc: Statechart) {
2      input_events = initialize_queue()
3      output_events = initialize_queue()
4      timers = initialize_set()
5      curr_state = sc.initial_state
6      for (var in sc.variables) {
7          var.value = var.initial_value
8      }
9      while (not finished()) {
10         curr_event = input_events.get()
11         enabled_transitions = find_enabled_transitions(curr_state, curr_event, sc.variables)
12         while (not quiescent()) {
13             chosen_transition = choose_one_transition(enabled_transitions)
14             cancel_timers(curr_state, timers)
15             curr_state = chosen_transition.target
16             chosen_transition.action.execute(sc.variables, output_events)
17             start_timers(curr_state, timers)
18             enabled_transitions = find_enabled_transitions(curr_state, sc.variables)
19         }
20     }
21 }
```

Testing Statecharts

Testing Statecharts

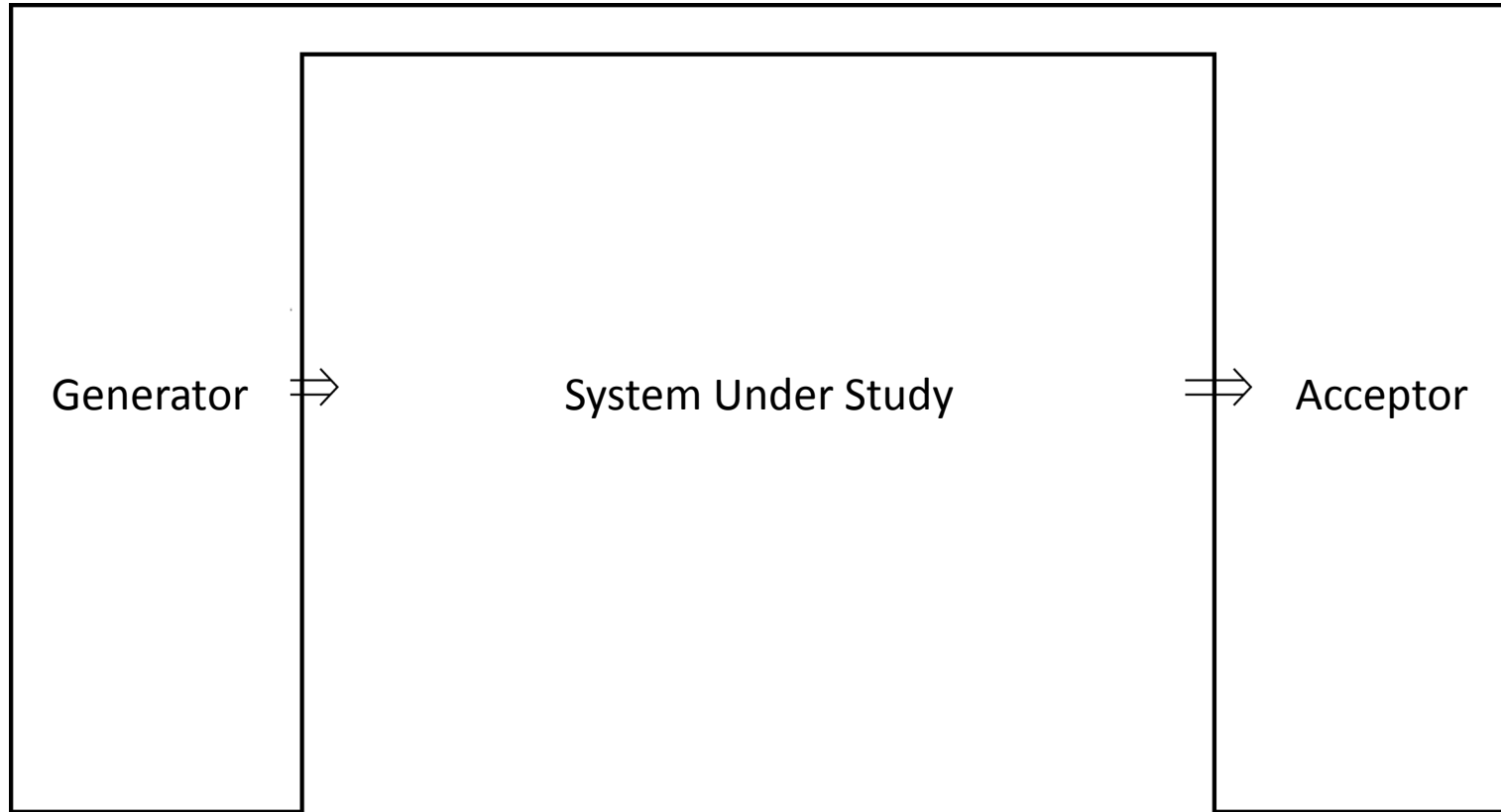

Zeigler BP. Theory of modelling and simulation. New York: Wiley-Interscience, 1976.

Mamadou K. Traoré, Alexandre Muzy, Capturing the dual relationship between simulation models and their context, Simulation Modelling Practice and Theory, Volume 14, Issue 2, February 2006, Pages 126-142.

Testing Statecharts

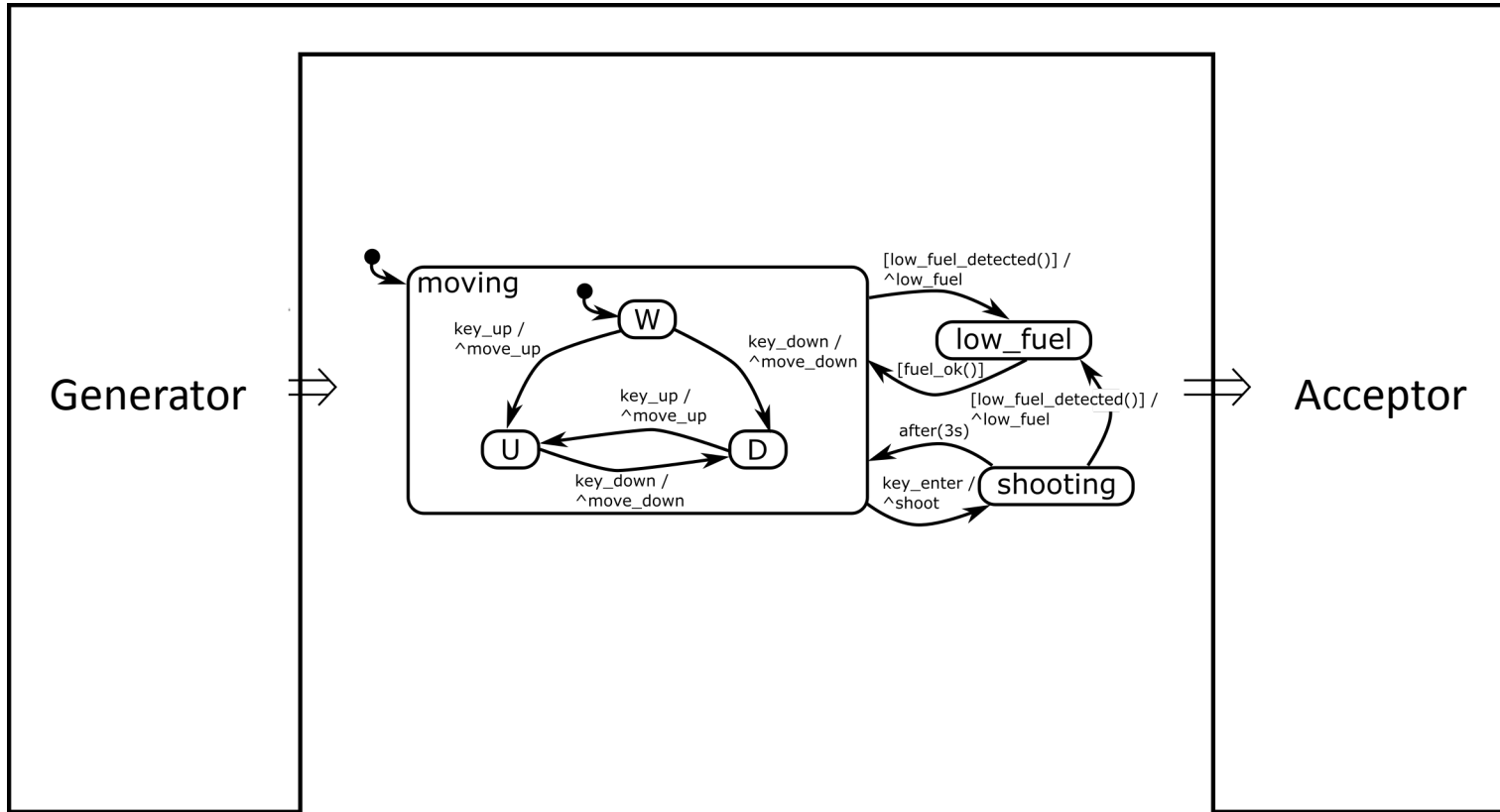

Zeigler BP. Theory of modelling and simulation. New York: Wiley-Interscience, 1976.

Mamadou K. Traoré, Alexandre Muzy, Capturing the dual relationship between simulation models and their context, Simulation Modelling Practice and Theory, Volume 14, Issue 2, February 2006, Pages 126-142.

Testing Statecharts

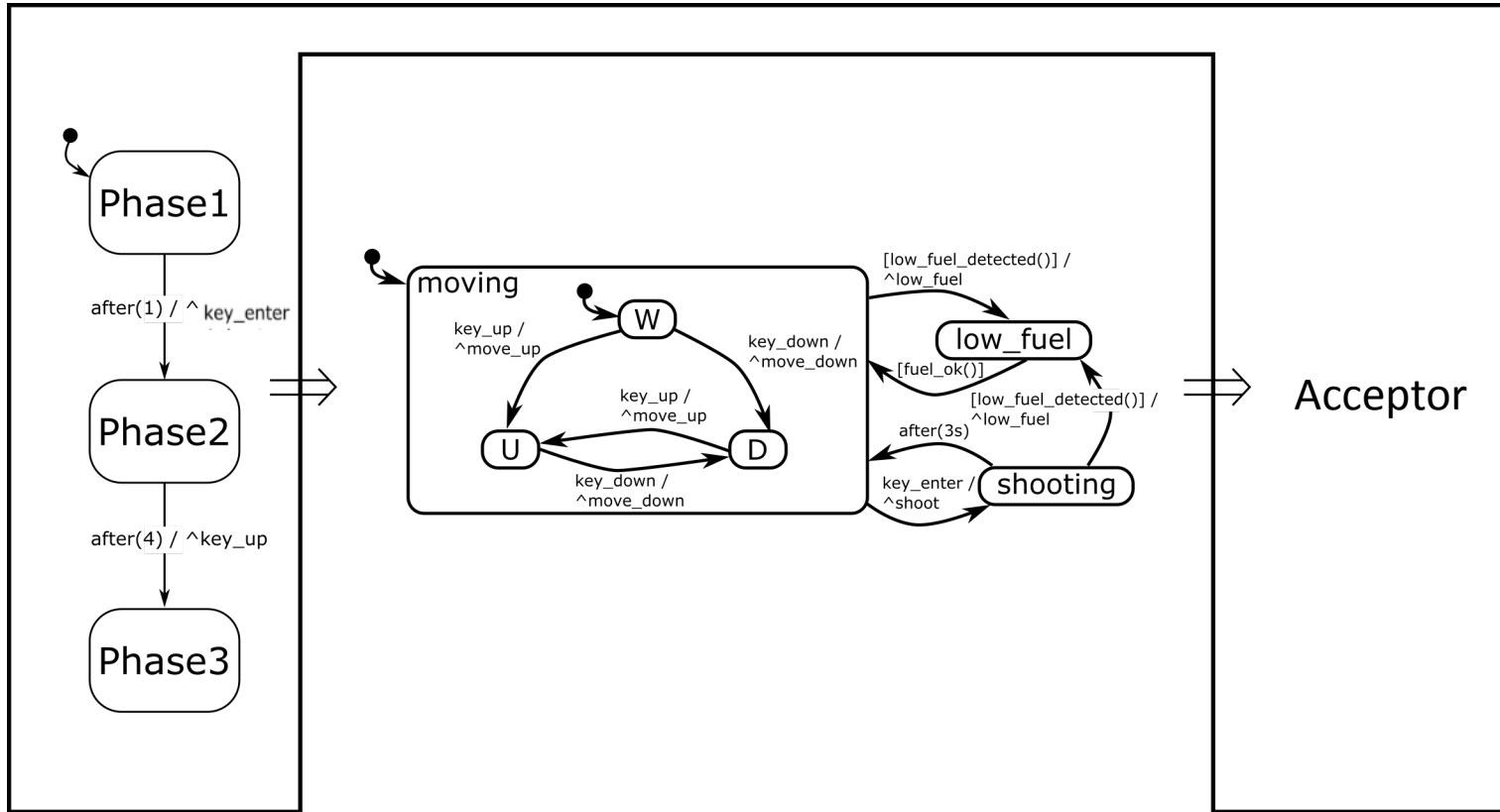

Zeigler BP. Theory of modelling and simulation. New York: Wiley-Interscience, 1976.

Mamadou K. Traoré, Alexandre Muzy, Capturing the dual relationship between simulation models and their context, Simulation Modelling Practice and Theory, Volume 14, Issue 2, February 2006, Pages 126-142.

Testing Statecharts

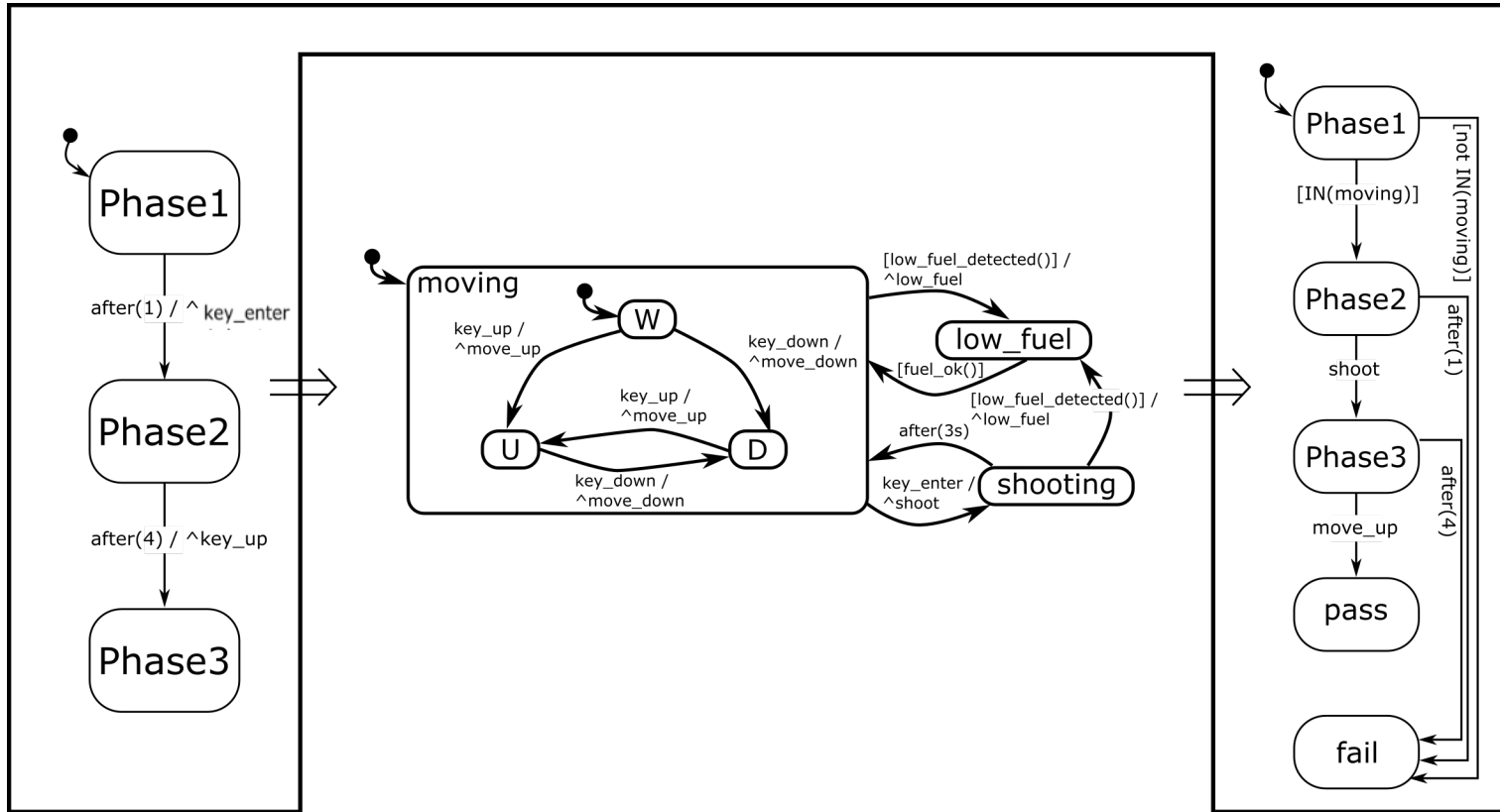

Zeigler BP. Theory of modelling and simulation. New York: Wiley-Interscience, 1976.

Mamadou K. Traoré, Alexandre Muzy, Capturing the dual relationship between simulation models and their context, Simulation Modelling Practice and Theory, Volume 14, Issue 2, February 2006, Pages 126-142.

- X-unit testing framework for YAKINDU Statechart Tools
- Test-driven development of Statechart models
- Test generation for various platforms
- Executable in YAKINDU Statechart Tools
- Virtual Time

Finished after 0,013 seconds

Runs: 1/1 Errors: 0 Failures: 0

✓ org.yakindu.sct.LightSwitchTest [Runner: JUnit 4] (0,001 s)
 ✓ initialStateIsOff (0,001 s)

```
testclass LightSwitchTest for statechart Light_Switch{
    @Test
    operation initialStateIsOff(){
        enter
        assert active(Light_Switch.main_region.Off)
    }
}
```



```
testclass someTestClass for statechart Light_Switch {  
  
}
```

- Has a unique name
- Has a reference to a statechart
- Contains one or more operations

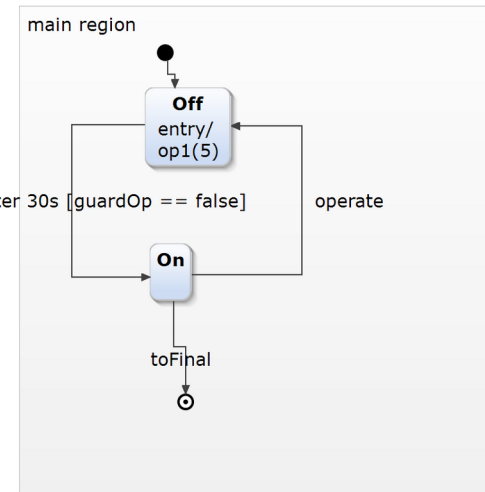
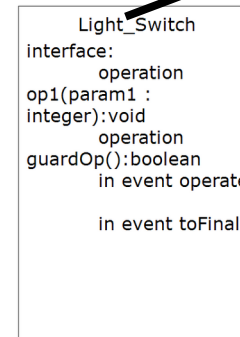



```
testsuite SomeTestSuite {  
    someTestClass  
}
```

- Has a unique name
- A testsuite contains at least one reference to a testclass



```
testclass someTestClass for statechart Light_Switch {  
    @Test  
    operation test(): void {  
        enter  
    }  
}
```

- May have @Test or @Run annotation
- Has a unique name
- May have 0..n parameters
- Has a return type (standard is void)
- Contains 0..n statements



// entering / exiting the statechart

enter, exit

// raising an event

raise event : value

// proceeding time or cycles

proceed 2 **cycle**

proceed 200 **ms**

// asserting an expression, expression must evaluate to boolean

assert expression

// is a state active

active(someStatechart.someRegion.someState)



SCTUnit allows to

- mock operations defined in the statechart model
- verify that an operation was called with certain values

// mocking the return value of an operation

mock mockOperation **returns** (20)

mock mockOperation(5) **returns** (30)

// verifying the call of an operation

assert called verifyOperation

assert called verifyOperation **with** (5, 10)



Control Structures

// if expression

```
if (x==5) {  
    doSomething()  
} else {  
    doSomethingelse()  
}
```

// while expression

```
while (x==5) {  
    doSomething()  
}
```

Test-Driven Development

- Software development process, where software is developed driven by tests
- Test-first-approach
- 3 steps you do repeatedly:
 - writing a test
 - implementing the logic
 - refactoring

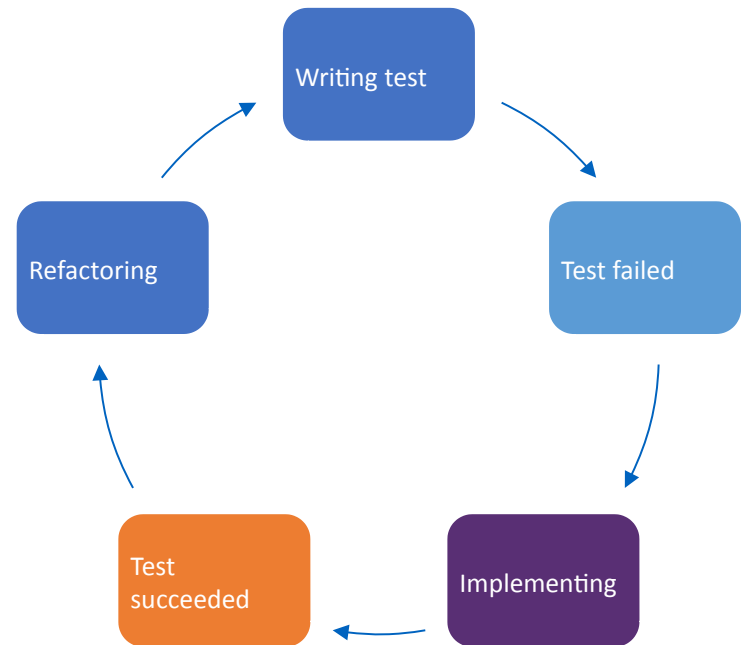

Exercise 3

Testing Models

Exercise 3 – Unit testing Statecharts

The statechart editor displays the following statechart for TrafficLightCtrl:

- main** region:
 - Starts at a black dot and transitions to the **Red** state with the action `/ raise displayRed`.
 - Red** state (green box):
 - Transition to **Green** state with the action `after redPeriod s / raise displayGreer`.
 - Green** state (yellow box):
 - Transition to **Yellow** state with the action `after greenPeriod s / raise displayYellow`.
 - Yellow** state (red box):
 - Transition back to **Red** state with the action `after yellowPeriod s / raise displayRed`.

The JUnit runner shows the following coverage table:

Model Element	Coverage
Statechart TrafficLightCtrl	50 % (6)
Region main	50 % (6)
State Red	100 % (2)
→ Red -> Green (after	100 % (1)
State Green	50 % (2)
→ Green -> Yellow (at	0 % (1)
State Yellow	0 % (2)
→ Yellow -> Red (after	0 % (1)

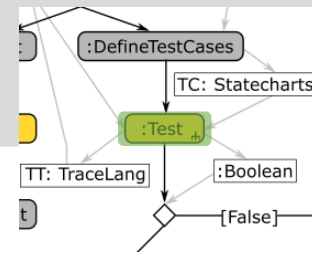

- Create a test that checks the following requirements:
 - R3: at system start-up, the red light is on
 - R4: cycles through red on, green on, and yellow on
 - R5: red is on for 60s, green is on for 55s, yellow is on for 5s

Exercise 3 – Solution

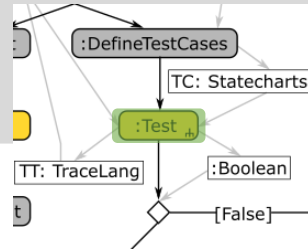

```
package trafficlight.test
```

```
testclass TrafficLightTests for statechart TrafficLightCtrl {
```

```
    @Test operation switchTrafficLightOn () {  
        // given the traffic light is inactive  
        assert !is_active  
        // when  
        enter  
        // then traffic light is off which means no color was switched on  
        assert displayRed  
        assert !displayGreen  
        assert !displayYellow  
    }
```

```
    @Test operation switchLightFromRedToGreen () {
```

```
        // given  
        switchTrafficLightOn  
        // when  
        proceed 60s  
        // then  
        assert displayGreen  
    }
```

```
    @Test operation switchLightFromGreenToYellow () {
```

```
        // given  
        switchLightFromRedToGreen  
        // when  
        proceed 55s  
        // then  
        assert displayYellow  
    }
```

```
    @Test operation switchLightFromYellowToRed () {
```

```
        // given  
        switchLightFromGreenToYellow  
        // when  
        proceed 5s  
        // then  
        assert displayRed  
    }
```

```
    @Test operation lightCycles () {
```

```
        // given  
        switchLightFromYellowToRed
```

```
        var i : integer = 10
```

```
        while (i > 0) {  
            i=i-1
```

```
                //when  
                proceed 60 s  
                // then  
                assert displayGreen
```

```
                //when  
                proceed 55 s  
                // then  
                assert displayYellow
```

```
                //when  
                proceed 5 s  
                // then  
                assert displayRed
```

```
        }
```

```
    }
```

```
}
```

Hierarchy

Entry/Exit Actions

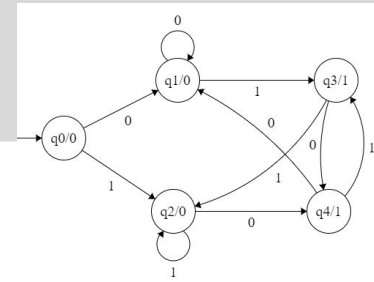

- A state can have entry and exit actions.
- An *entry action* is executed whenever a state is entered (made active).
- An *exit action* is executed whenever a state is exited (made *inactive*).
- Same expressiveness as *transition actions* (i.e., syntactic sugar).

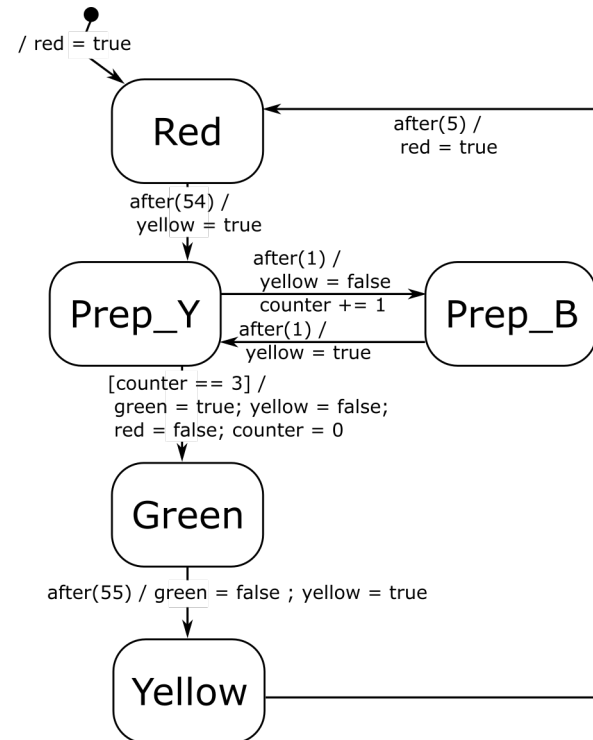
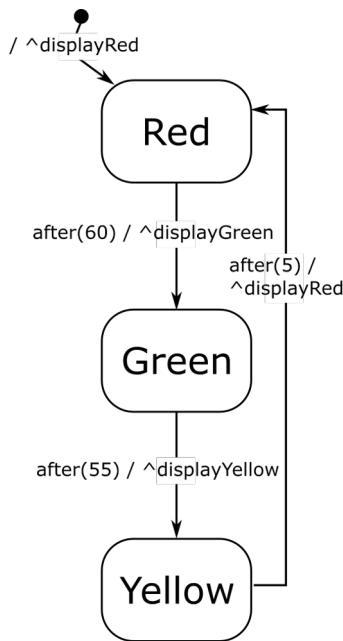

Entry/Exit Actions

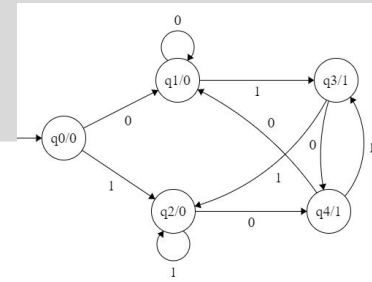

- A state can have entry and exit actions.
- An *entry action* is executed whenever a state is entered (made active).
- An *exit action* is executed whenever a state is exited (made *inactive*).
- Same expressiveness as *transition actions* (i.e., syntactic sugar).

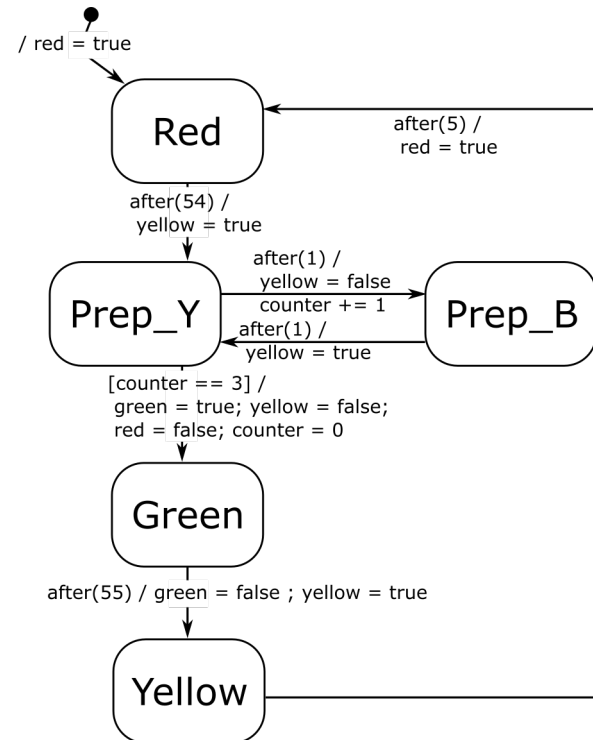
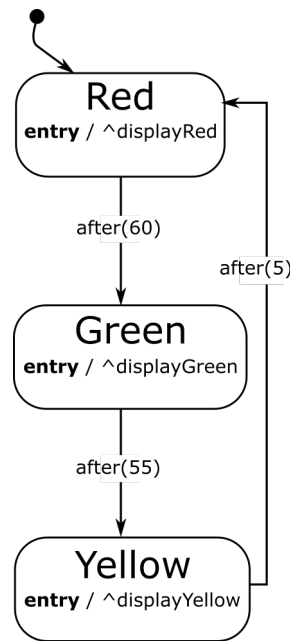

Entry/Exit Actions

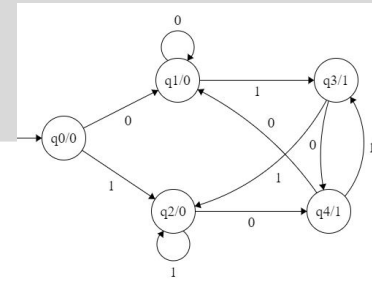

- A state can have entry and exit actions.
- An *entry action* is executed whenever a state is entered (made active).
- An *exit action* is executed whenever a state is exited (made *inactive*).
- Same expressiveness as *transition actions* (i.e., syntactic sugar).

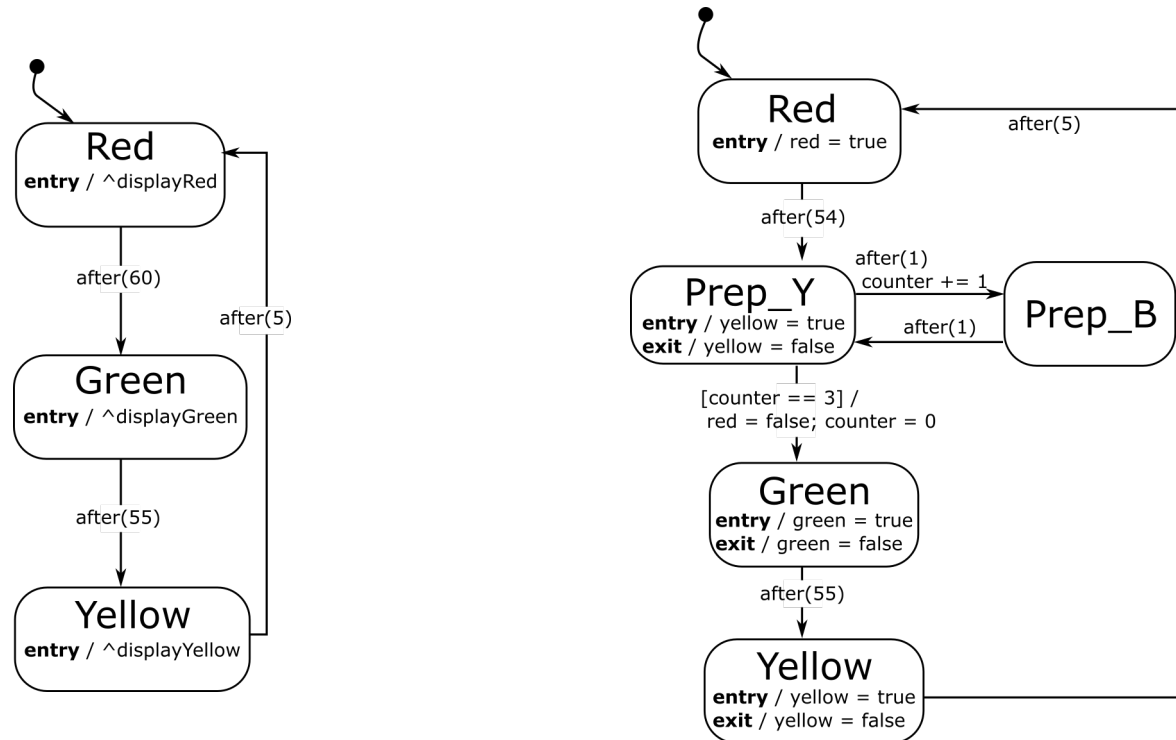

Transitions

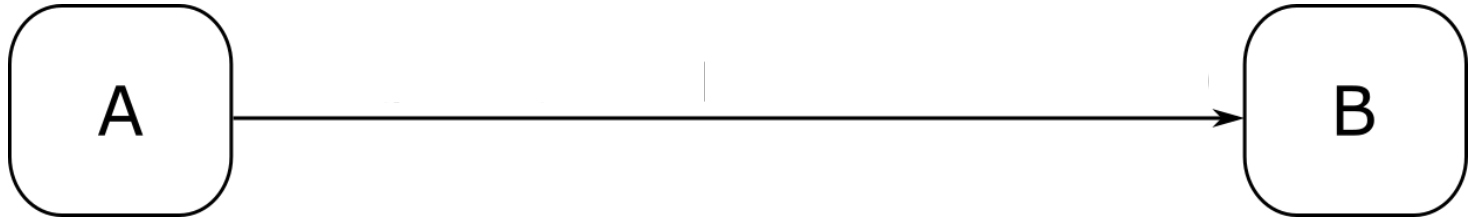

- Model the **dynamics** of the system:

Transitions

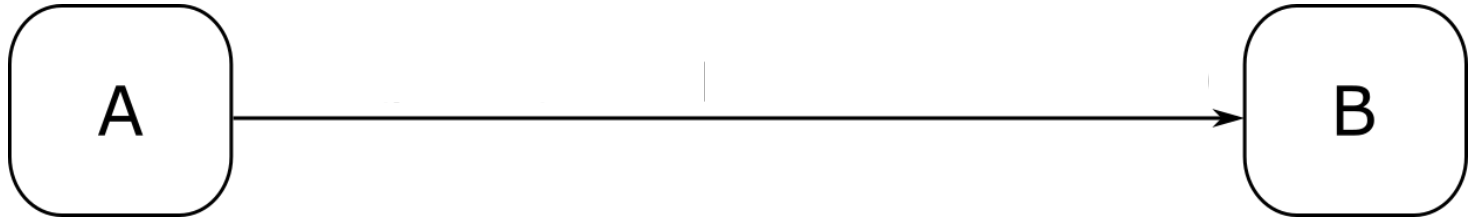

- Model the **dynamics** of the system:
 - *if*

Transitions

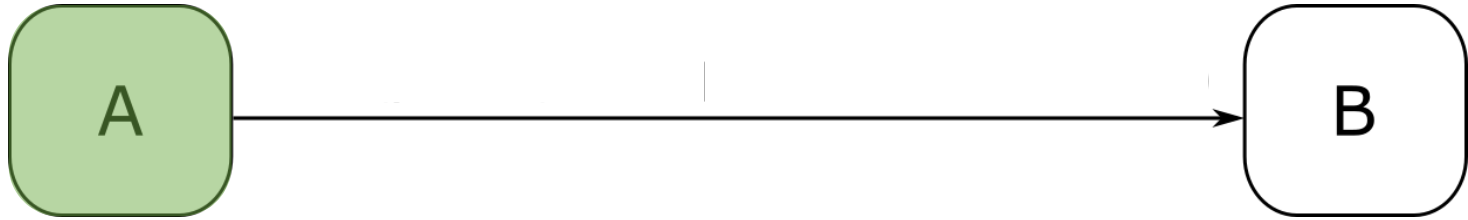

- Model the **dynamics** of the system:
 - *if*
 - the system is **in state A**

Transitions

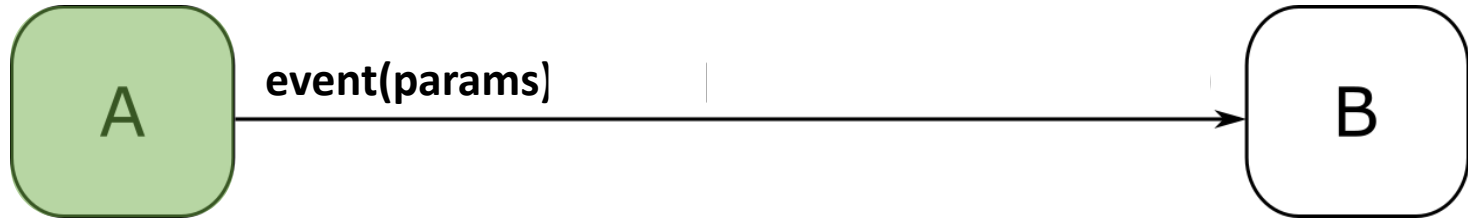

- Model the **dynamics** of the system:
 - *if*
 - the system is **in state A**
 - and **event is processed**

Transitions

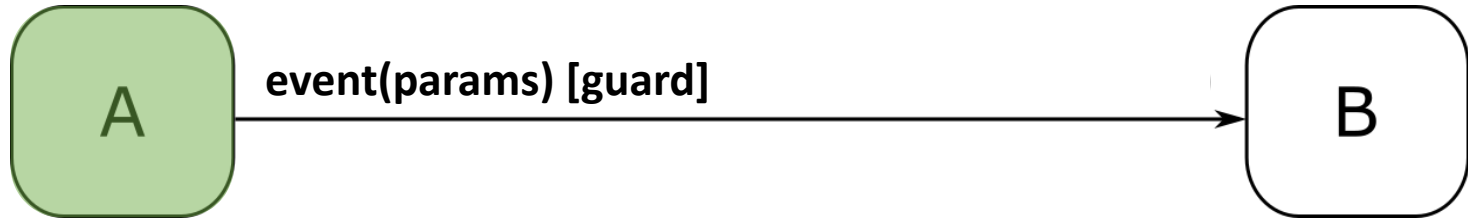

- Model the **dynamics** of the system:
 - *if*
 - the system is **in state A**
 - and **event is processed**
 - and **guard** evaluates to **true**

Transitions

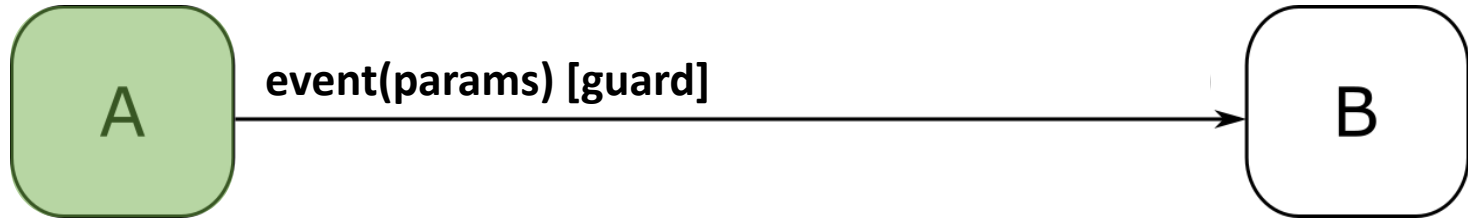

- Model the **dynamics** of the system:
 - *if*
 - the system is **in state A**
 - and **event is processed**
 - and **guard** evaluates to **true**
 - *then*

Transitions

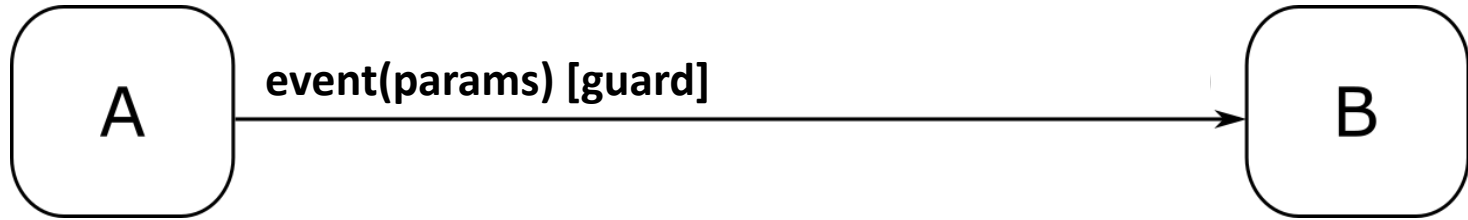

- Model the **dynamics** of the system:
 - *if*
 - the system is **in state A**
 - and **event is processed**
 - and **guard** evaluates to **true**
 - *then*
 1. the **exit actions** of state A are evaluated

Transitions

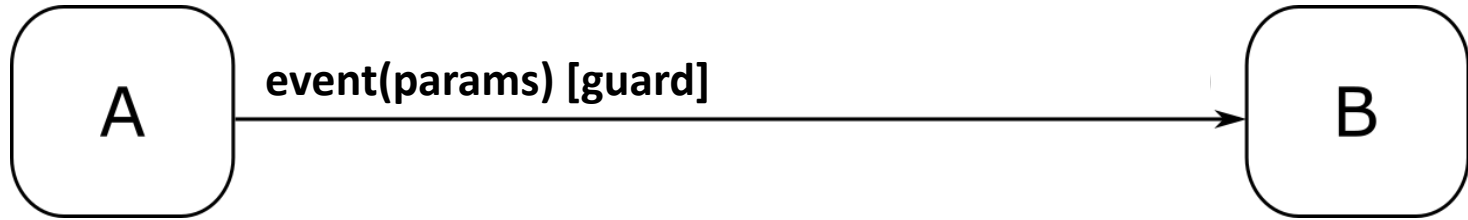

- Model the **dynamics** of the system:
 - *if*
 - the system is **in state A**
 - and **event is processed**
 - and **guard** evaluates to **true**
 - *then*
 1. the **exit actions** of state A are evaluated
 2. and **output_action** is evaluated

Transitions

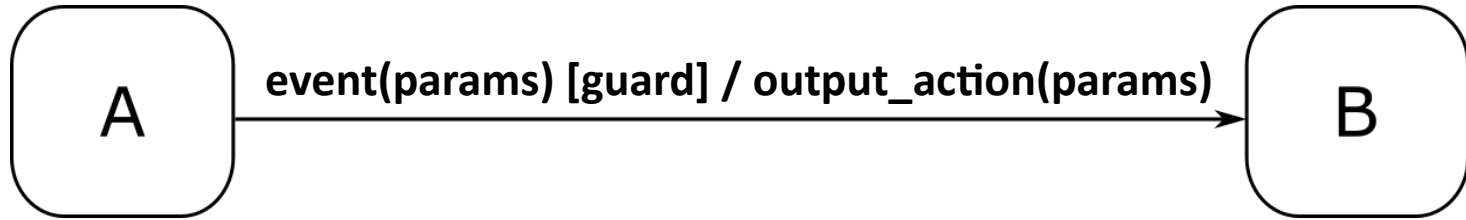

- Model the **dynamics** of the system:
 - *if*
 - the system is **in state A**
 - and **event is processed**
 - and **guard** evaluates to **true**
 - *then*
 1. the **exit actions** of state A are evaluated
 2. and **output_action** is evaluated
 3. and the **enter actions** of state B are evaluated

Transitions

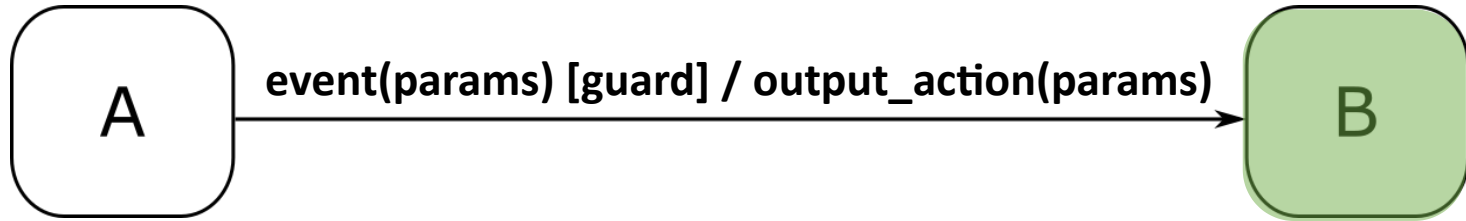

- Model the **dynamics** of the system:
 - *if*
 - the system is **in state A**
 - and **event is processed**
 - and **guard** evaluates to **true**
 - *then*
 1. the **exit actions** of state A are evaluated
 2. and **output_action** is evaluated
 3. and the **enter actions** of state B are evaluated
 4. the new **active state** is B

Entry/Exit Actions: Simulation Algorithm

```
1  simulate(sc: Statechart) {
2      input_events = initialize_queue()
3      output_events = initialize_queue()
4      timers = initialize_set()
5      curr_state = sc.initial_state
6      for (var in sc.variables) {
7          var.value = var.initial_value
8      }
9      while (not finished()) {
10         curr_event = input_events.get()
11         enabled_transitions = find_enabled_transitions(curr_state, curr_event, sc.variables)
12         while (not quiescent()) {
13             chosen_transition = choose_one_transition(enabled_transitions)
14             cancel_timers(curr_state, timers)
15             execute_exit_actions(curr_state)
16             curr_state = chosen_transition.target
17             chosen_transition.action.execute(sc.variables, output_events)
18             execute_enter_actions(curr_state)
19             start_timers(curr_state, timers)
20             enabled_transitions = find_enabled_transitions(curr_state, sc.variables)
21         }
22     }
23 }
24
```

Hierarchy

- Statechart states can be hierarchically (de-) **composed**
- Each hierarchical state has exactly one **initial/default state**
- An active hierarchical state has **exactly one active child** (down to leaf/atomic state)

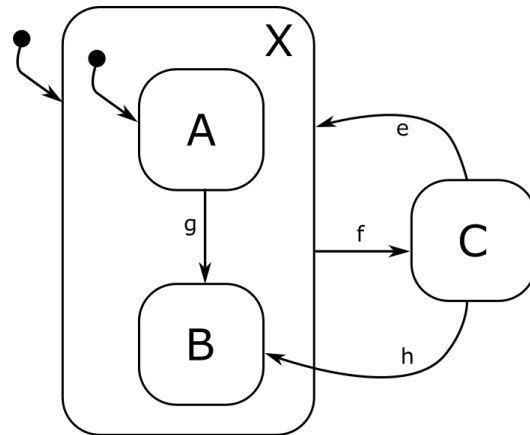

Hierarchy

- Statechart states can be hierarchically (de-) **composed**
- Each hierarchical state has exactly one **initial/default state**
- An active hierarchical state has **exactly one active child** (down to leaf/atomic state)

Semantics/Meaning?

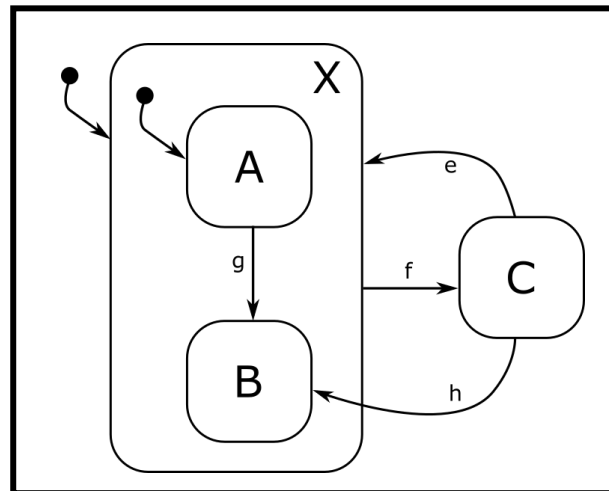

Hierarchy

- Statechart states can be hierarchically (de-) **composed**
- Each hierarchical state has exactly one **initial/default state**
- An active hierarchical state has **exactly one active child** (down to leaf/atomic state)

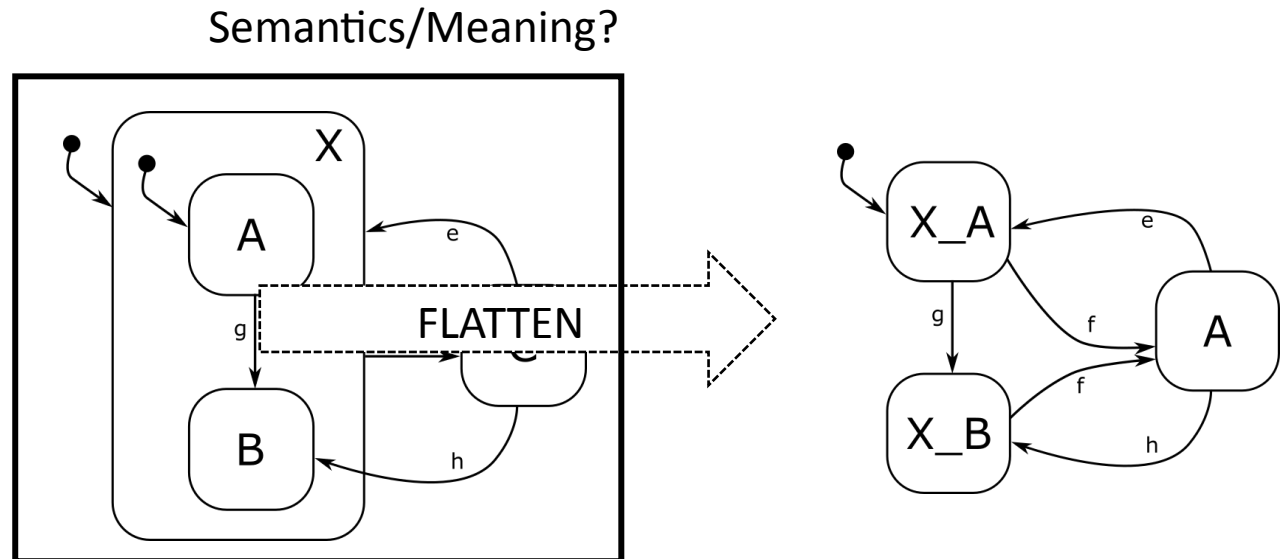

Hierarchy: Modified Example

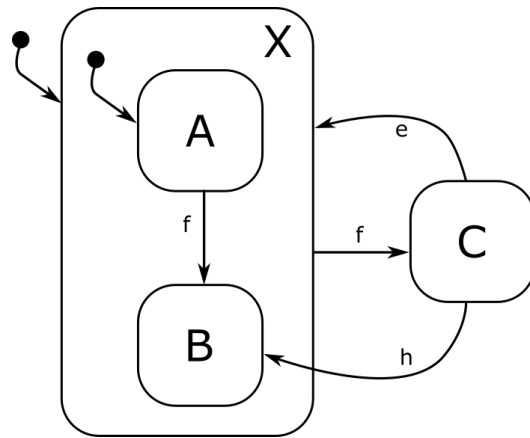

Hierarchy: Modified Example

Semantics/Meaning?

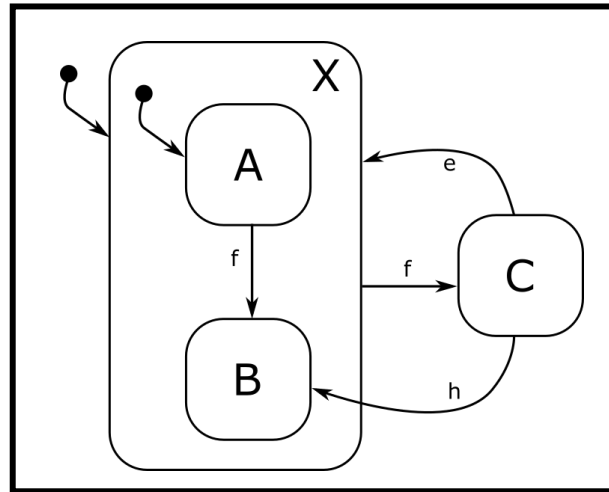

Hierarchy: Modified Example

Semantics/Meaning?

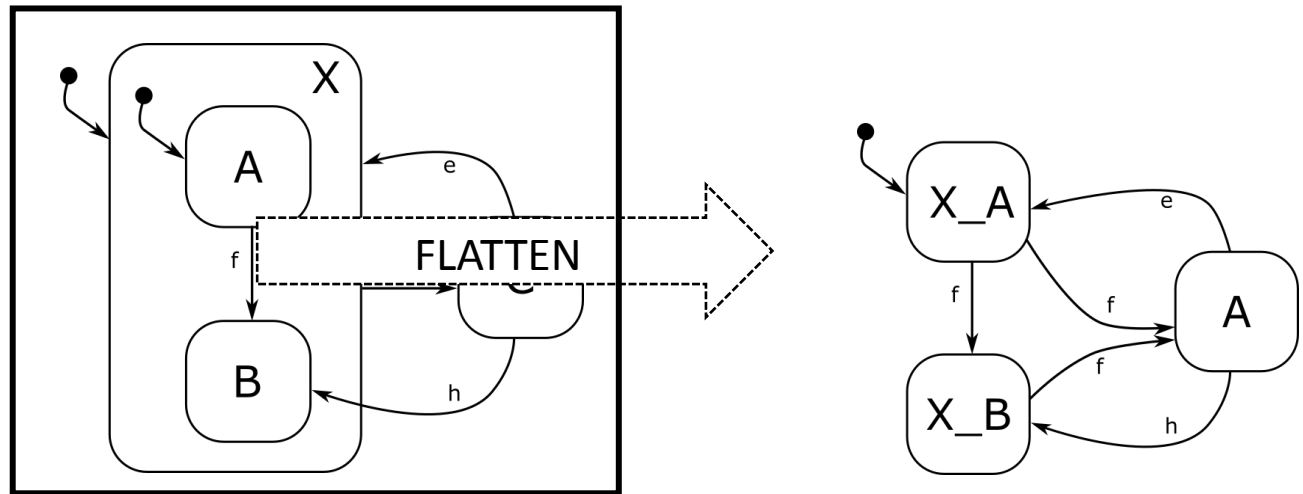

Hierarchy: Modified Example

Semantics/Meaning?

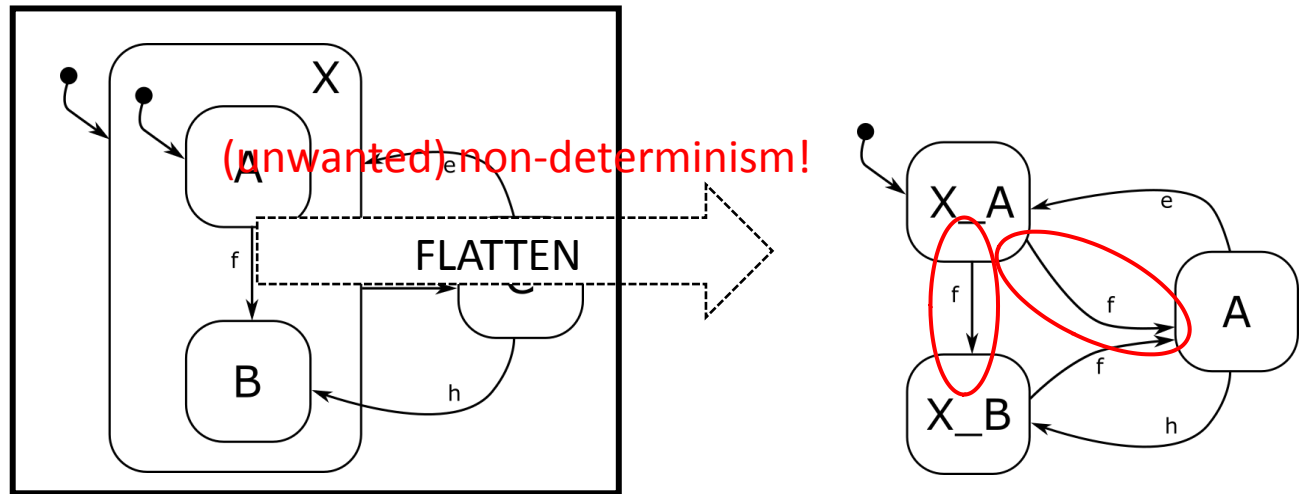

(unwanted) non-determinism!

Hierarchy: Modified Example

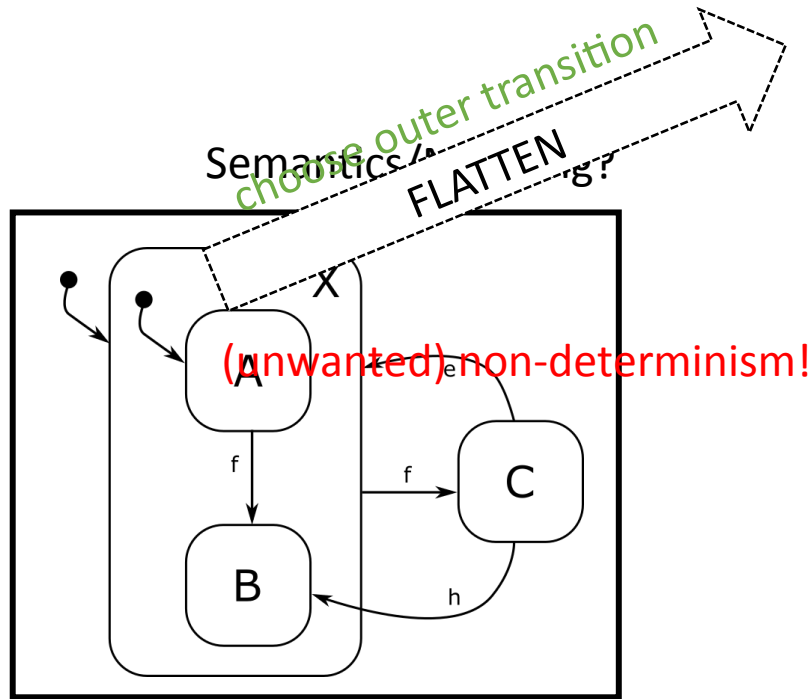

Statemate, Yakindu, ...

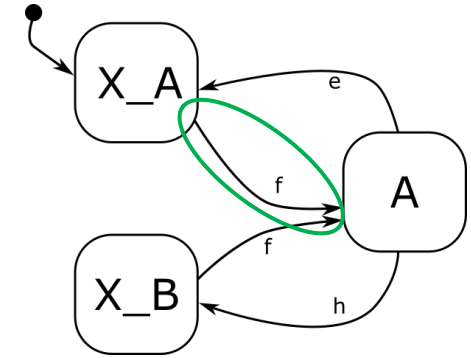

Hierarchy: Modified Example

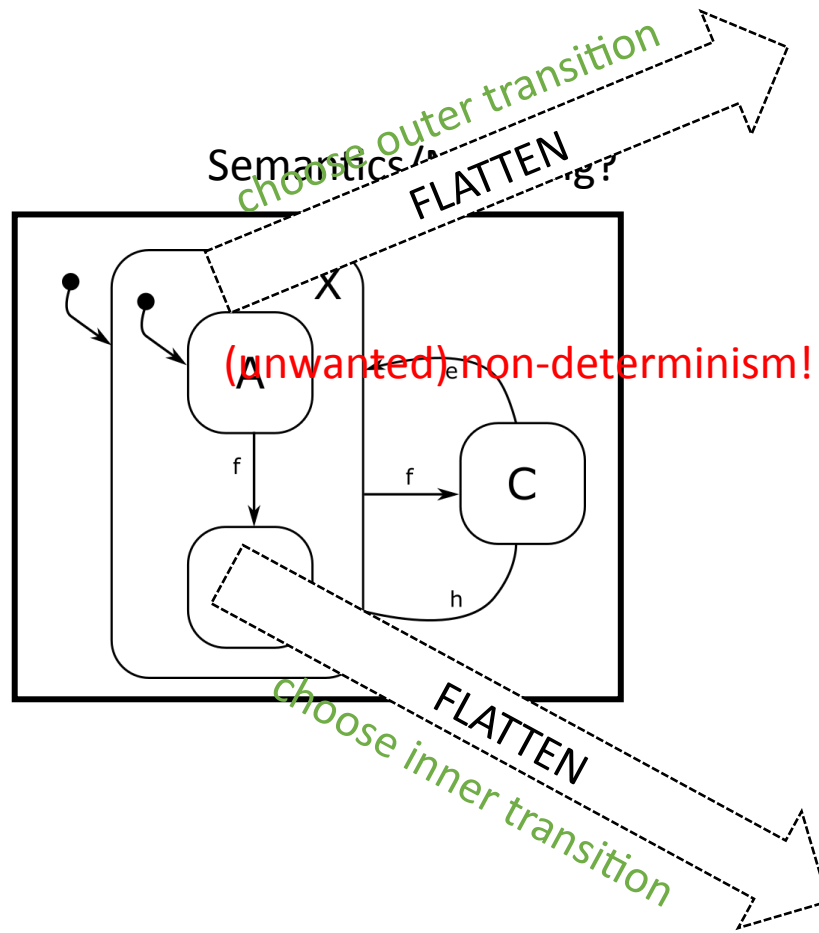

Statemate, Yakindu, ...

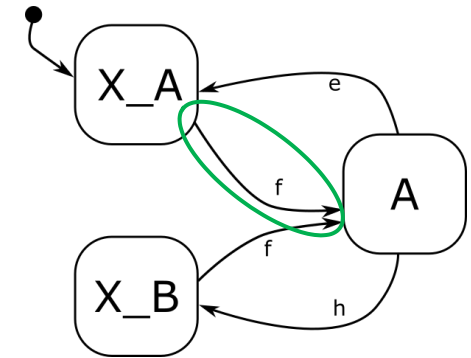

Rhapsody, ...

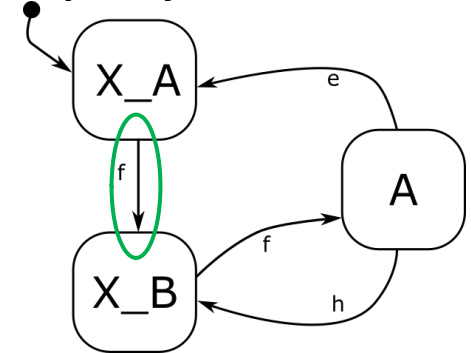

Hierarchy: Modified Example

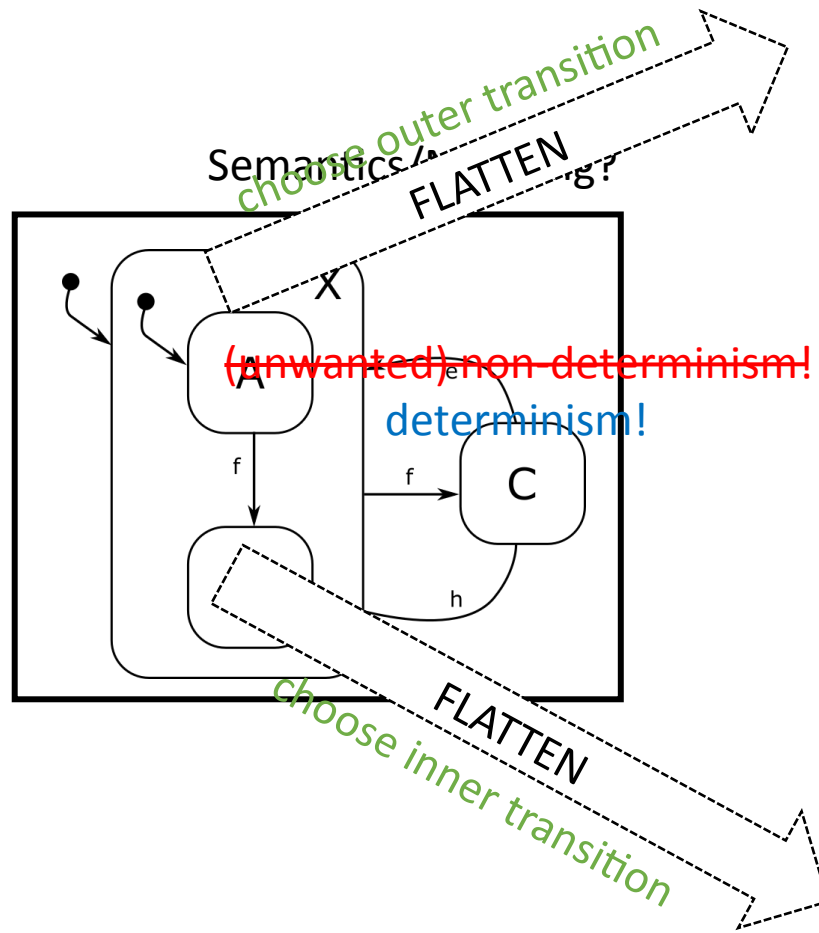

Statemate, Yakindu, ...

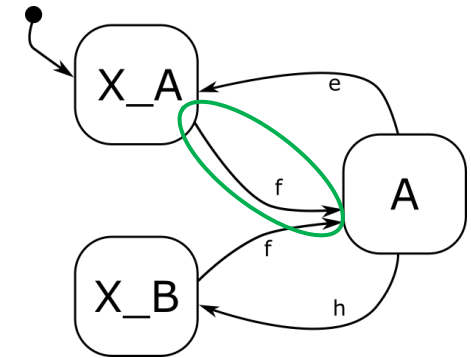

Rhapsody, ...

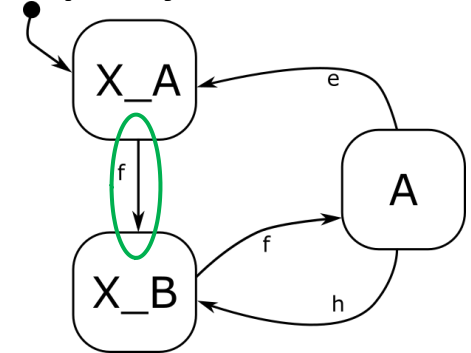

Hierarchy: why inner? ... see Code Generation



Composite States

- Hierarchical states are an ideal mechanism for hiding complexity
- Parent states can implement common behaviour for their substates
- Hierarchical event processing **reduces the number of transitions**
- Refactoring support: group states into a composite state

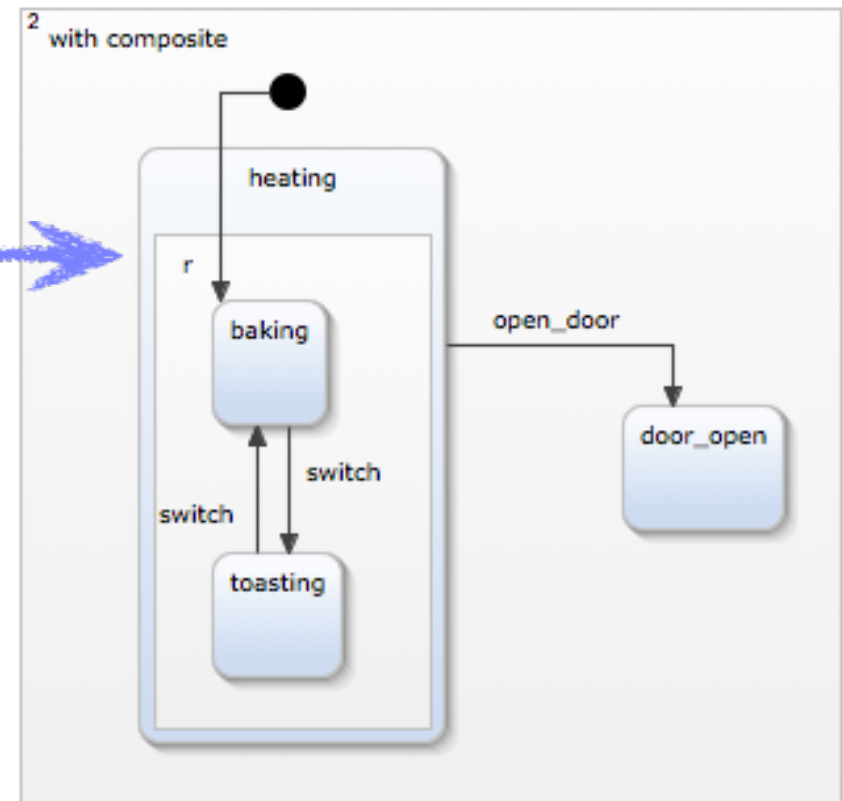
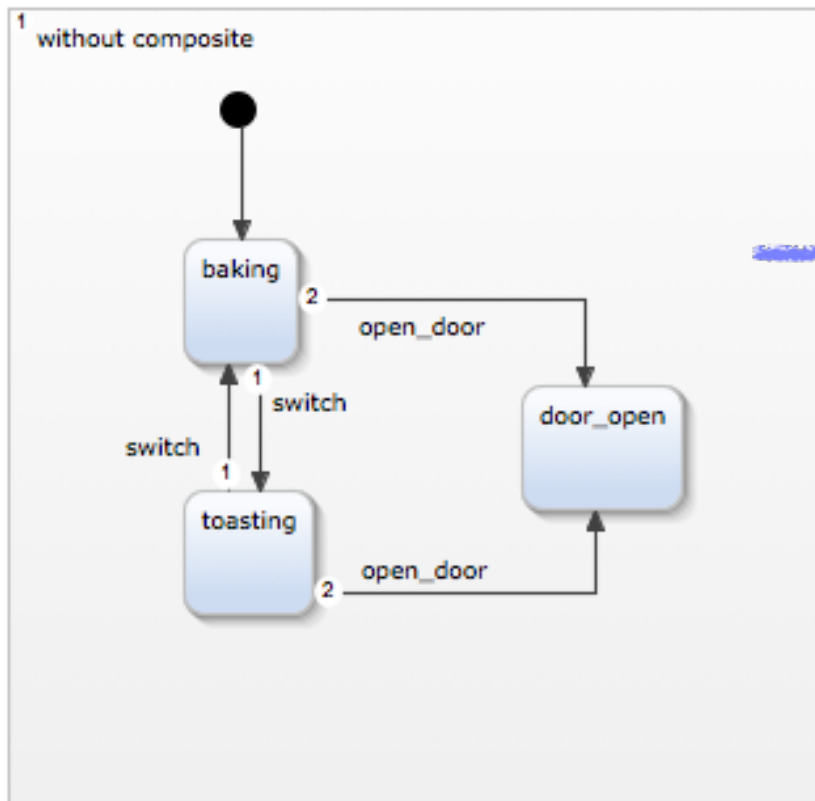

Hierarchy: Initialization

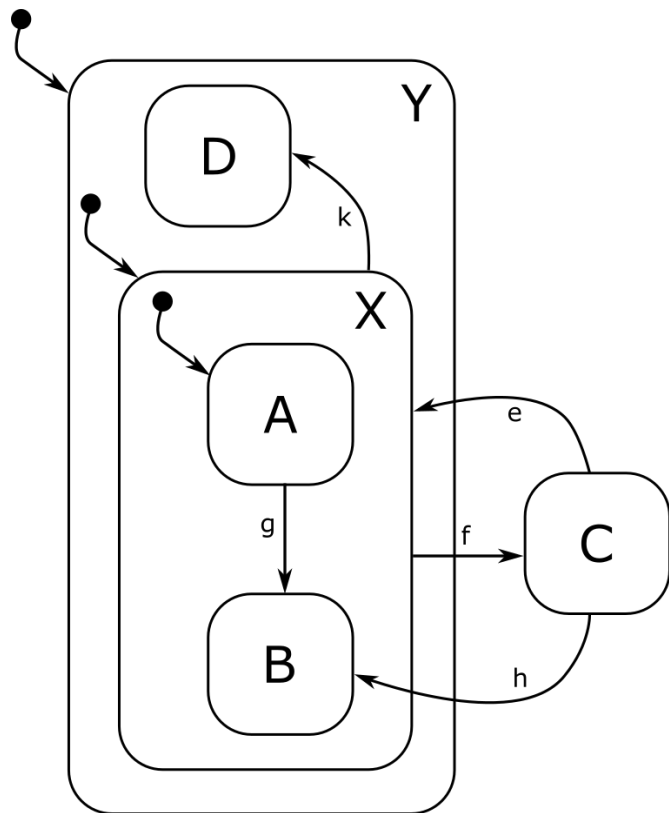

- Concept of **effective target state**
 - Recursive: the effective target state of a composite state is its initial state
- Effective target state of initial transition is $Y/X/A$
- Initialization:
 1. Enter Y, execute enter action
 2. Enter X, execute enter action
 3. Enter A, execute enter action

Hierarchy: Transitions

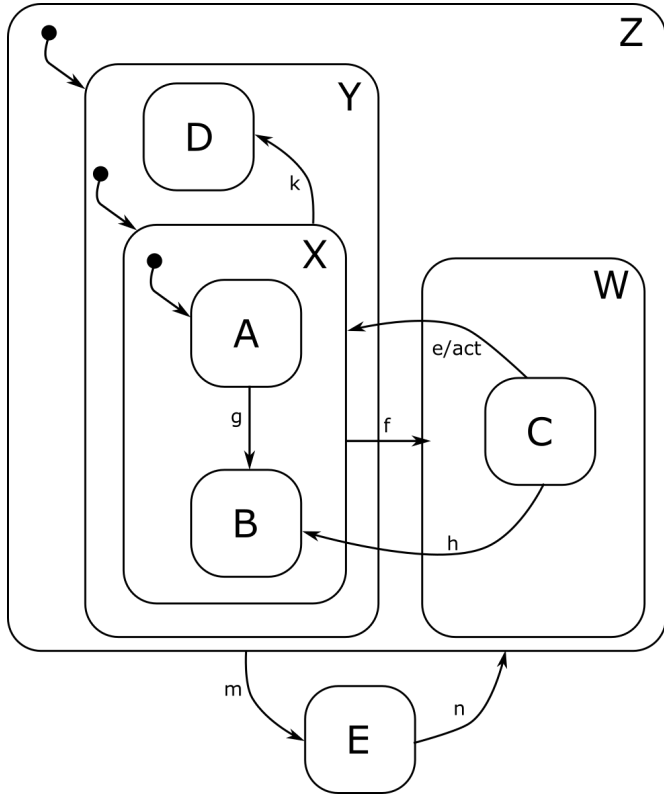

Hierarchy: Transitions

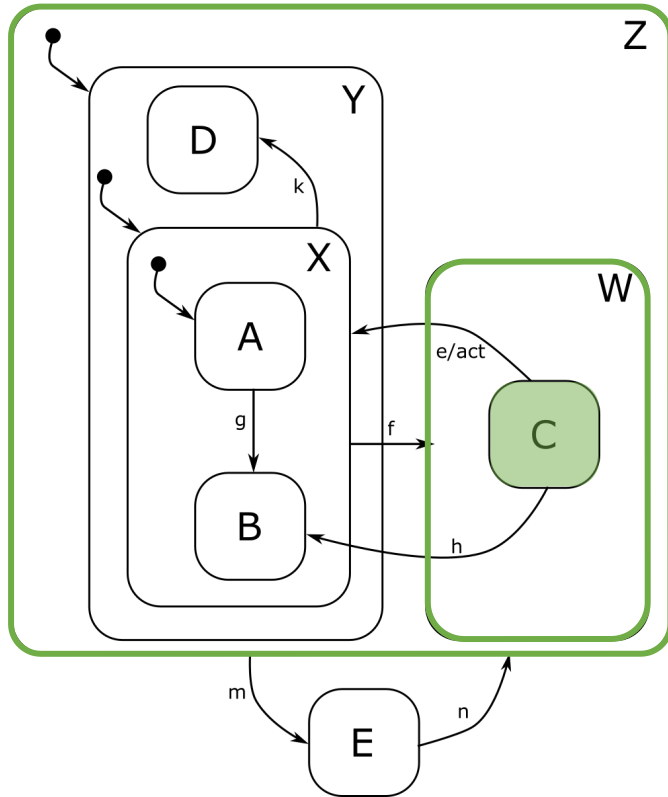

- Assume Z/W/C is active and e is processed.

Hierarchy: Transitions

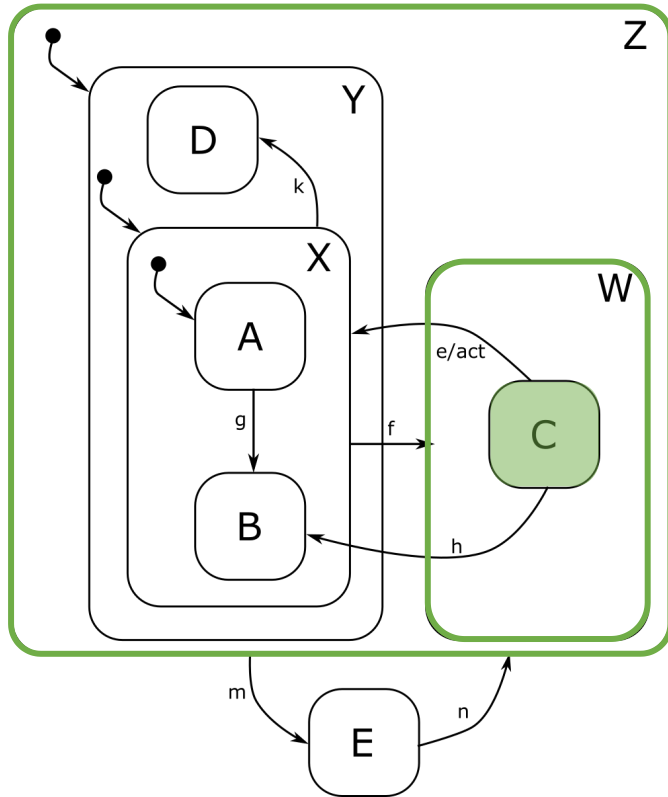

- Assume Z/W/C is active and e is processed.
- Semantics:

Hierarchy: Transitions

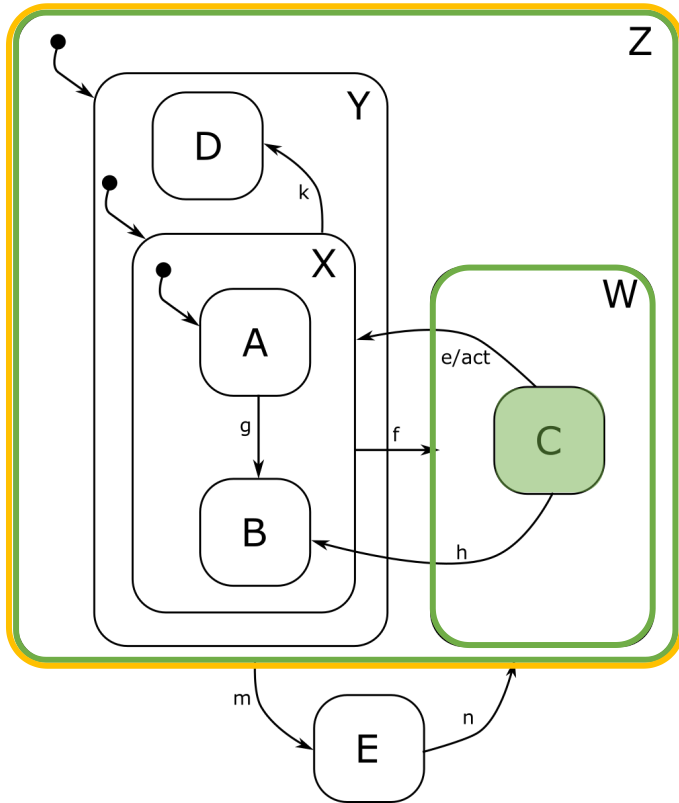

- Assume $Z/W/C$ is active and e is processed.
- Semantics:
 1. Find LCA, collect states to leave

Hierarchy: Transitions

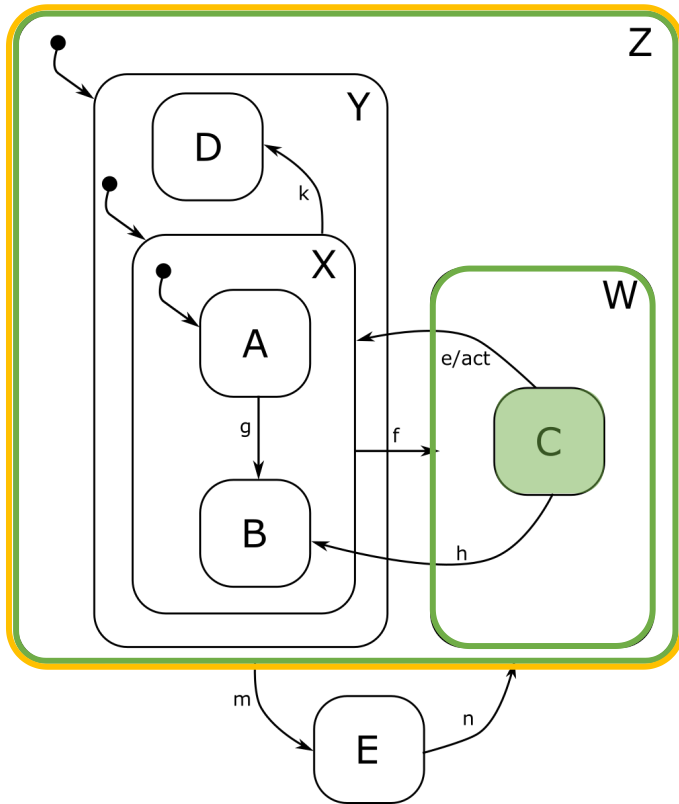

- Assume $Z/W/C$ is active and e is processed.
- Semantics:
 1. Find LCA, collect states to leave
 2. Leave states up the hierarchy

Hierarchy: Transitions

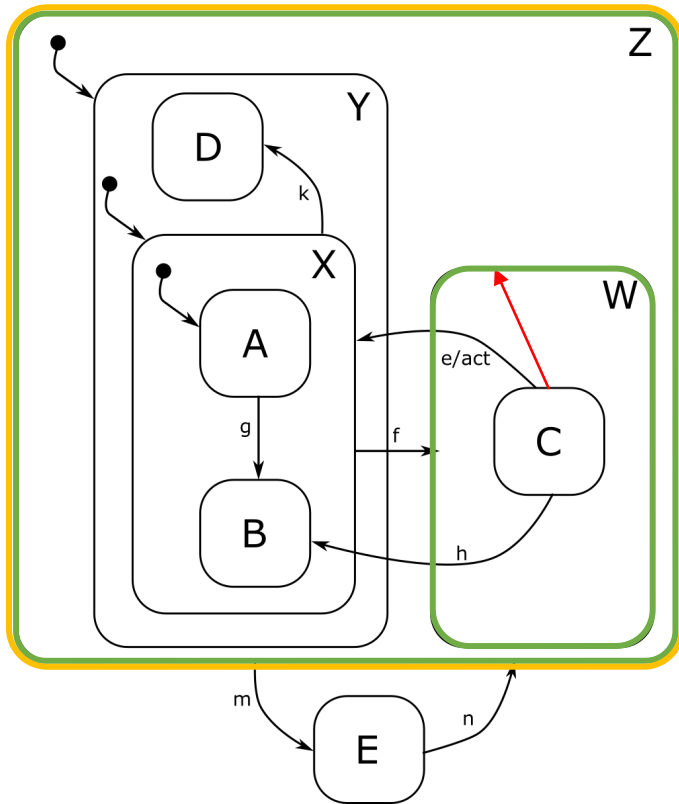

- Assume Z/W/C is active and e is processed.
- Semantics:
 1. Find LCA, collect states to leave
 2. Leave states up the hierarchy

Hierarchy: Transitions

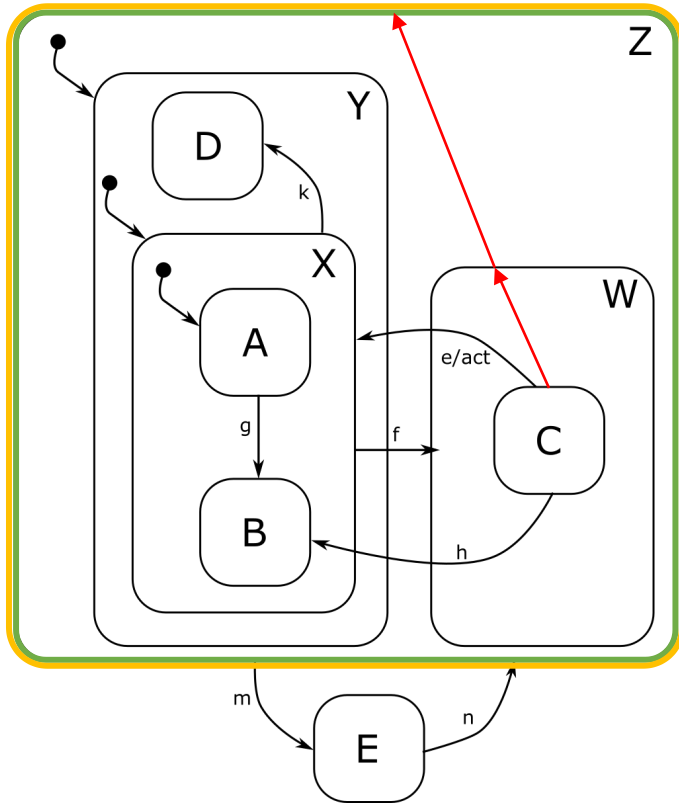

- Assume Z/W/C is active and e is processed.
- Semantics:
 1. Find LCA, collect states to leave
 2. Leave states up the hierarchy

Hierarchy: Transitions

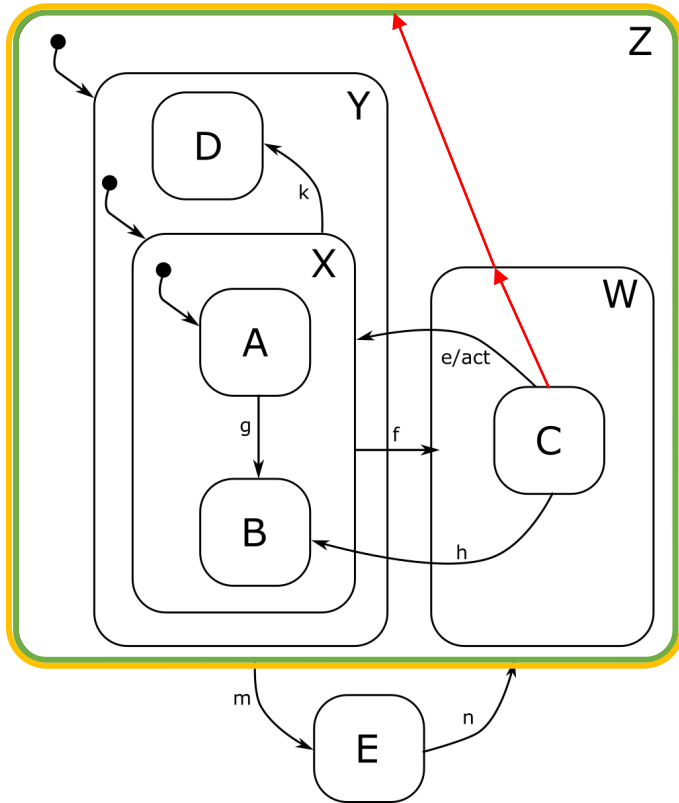

- Assume $Z/W/C$ is active and e is processed.
- Semantics:
 1. Find LCA, collect states to leave
 2. Leave states up the hierarchy
 3. Execute action *act*

Hierarchy: Transitions

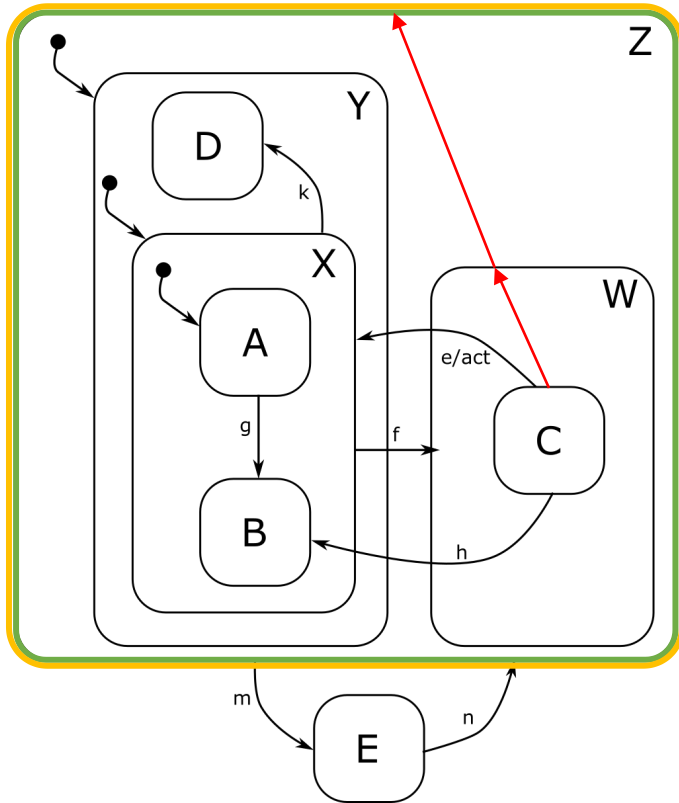

- Assume $Z/W/C$ is active and e is processed.
- Semantics:
 1. Find LCA, collect states to leave
 2. Leave states up the hierarchy
 3. Execute action act
 4. Find effective target state set, enter states down the hierarchy

Hierarchy: Transitions

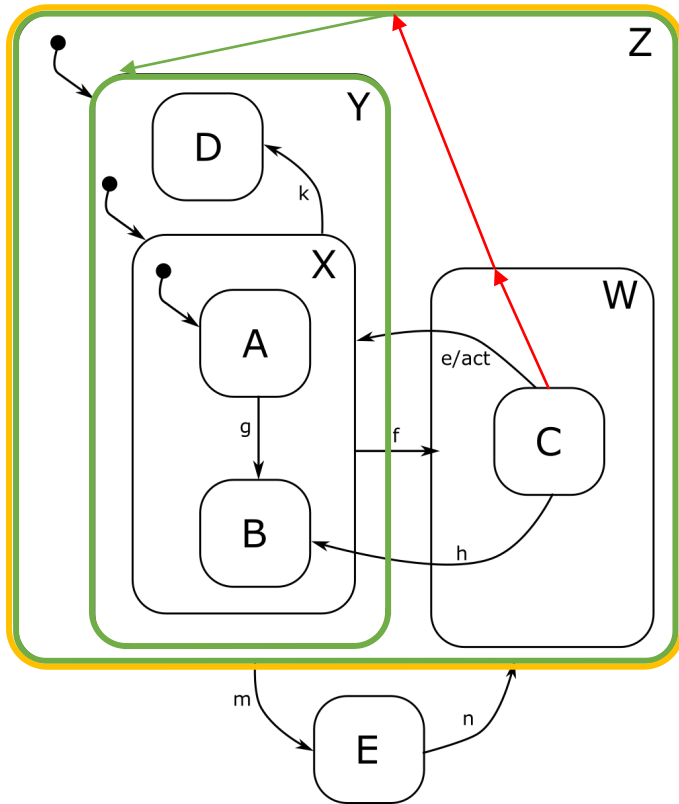

- Assume $Z/W/C$ is active and e is processed.
- Semantics:
 1. Find LCA, collect states to leave
 2. Leave states up the hierarchy
 3. Execute action act
 4. Find effective target state set, enter states down the hierarchy

Hierarchy: Transitions

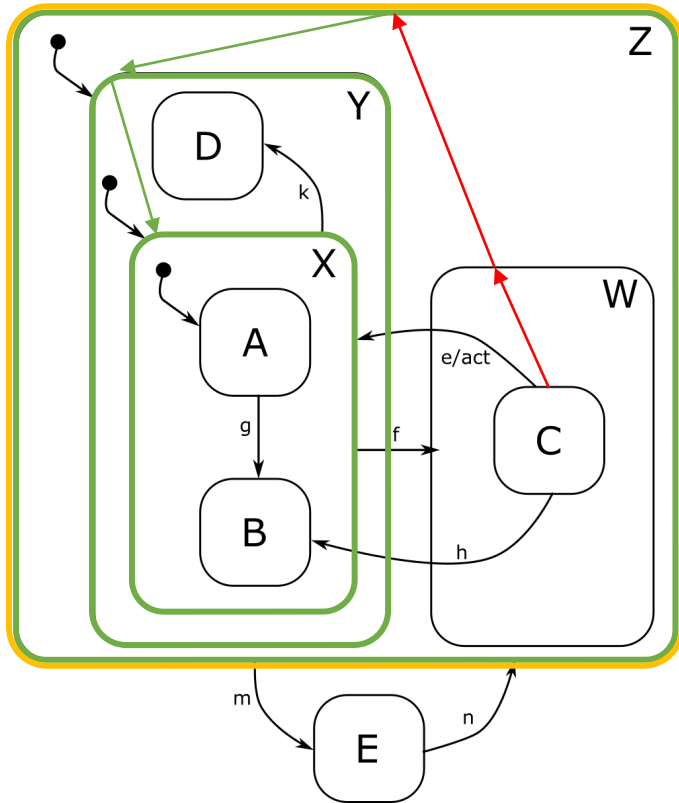

- Assume Z/W/C is active and e is processed.
- Semantics:
 1. Find LCA, collect states to leave
 2. Leave states up the hierarchy
 3. Execute action act
 4. Find effective target state set, enter states down the hierarchy

Hierarchy: Transitions

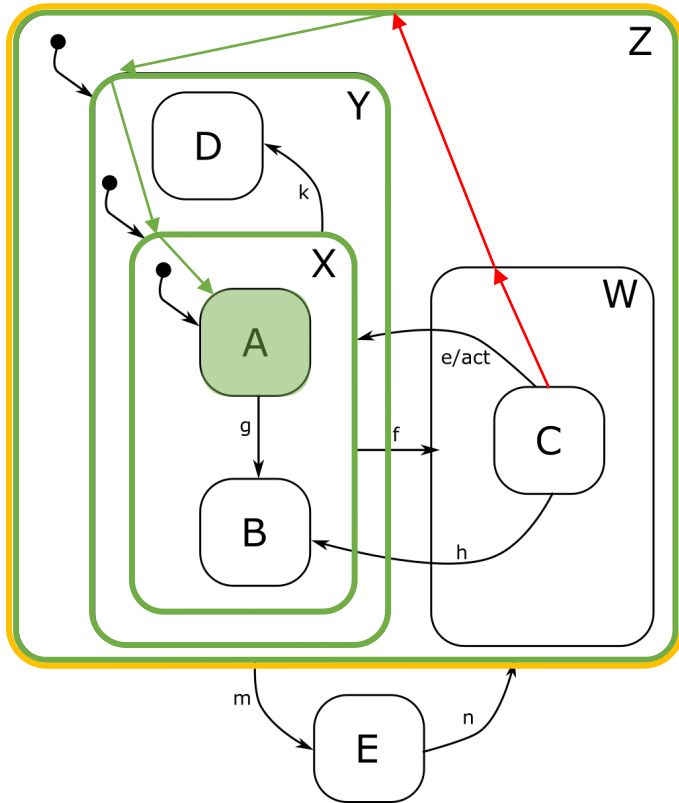

- Assume $Z/W/C$ is active and e is processed.
- Semantics:
 1. Find LCA, collect states to leave
 2. Leave states up the hierarchy
 3. Execute action act
 4. Find effective target state set, enter states down the hierarchy

Hierarchy: Transitions

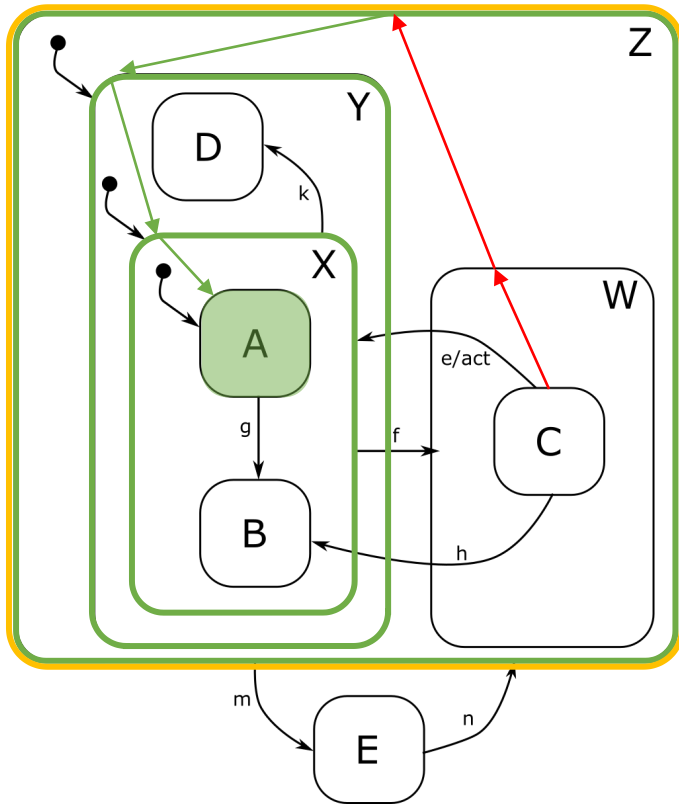

- Assume Z/W/C is active and e is processed.
- Semantics:
 1. Find LCA, collect states to leave
 2. Leave states up the hierarchy
 3. Execute action *act*
 4. Find effective target state set, enter states down the hierarchy

Effective target states:

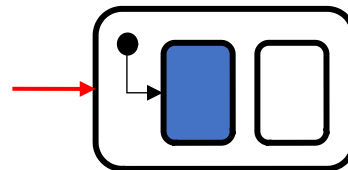

RECURSIVE!

Exercise 5

Model an
interruptible traffic light

Exercise 5 - Requirements

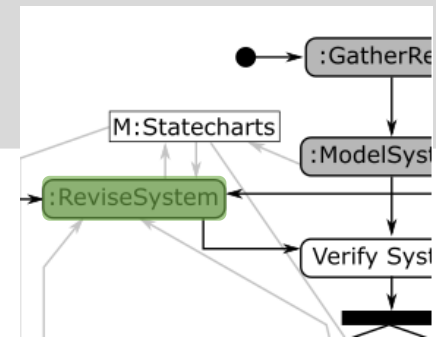
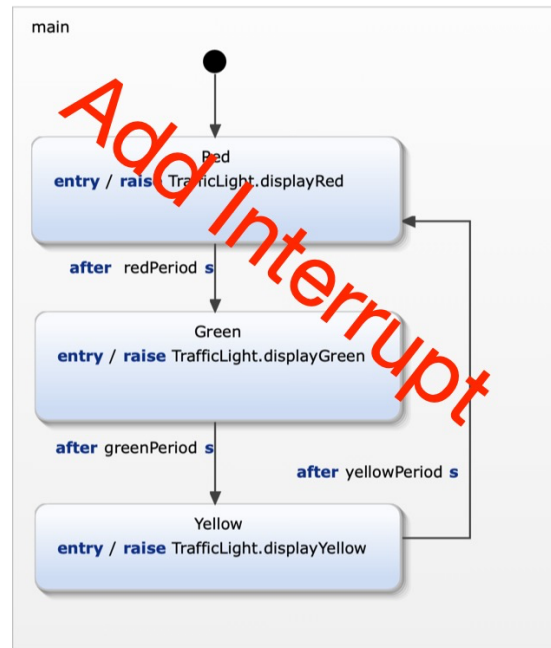

- R7a: police can interrupt autonomous operation .
- R7b: autonomous operation can be interrupted during any phase of constant red, yellow and green lights.
- R7c: in interrupted mode the yellow light blinks with a constant frequency of 1 Hz (on 0.5s, off 0.5s).
- R8a: police can resume to regular autonomous operation.
- R8b: when regular operation is resumed, the traffic light restarts with red (R) light on.

Exercise 5: Solution

- R7a: police can interrupt autonomous operation .
- R7b: autonomous operation can be interrupted during any phase of constant red, yellow and green lights.
- R7c: in interrupted mode the yellow light blinks with a constant frequency of 1 Hz (on 0.5s, off 0.5s).
- R8a: police can resume to regular autonomous operation.
- R8b: when regular operation is resumed, the traffic light restarts with red (R) light on.

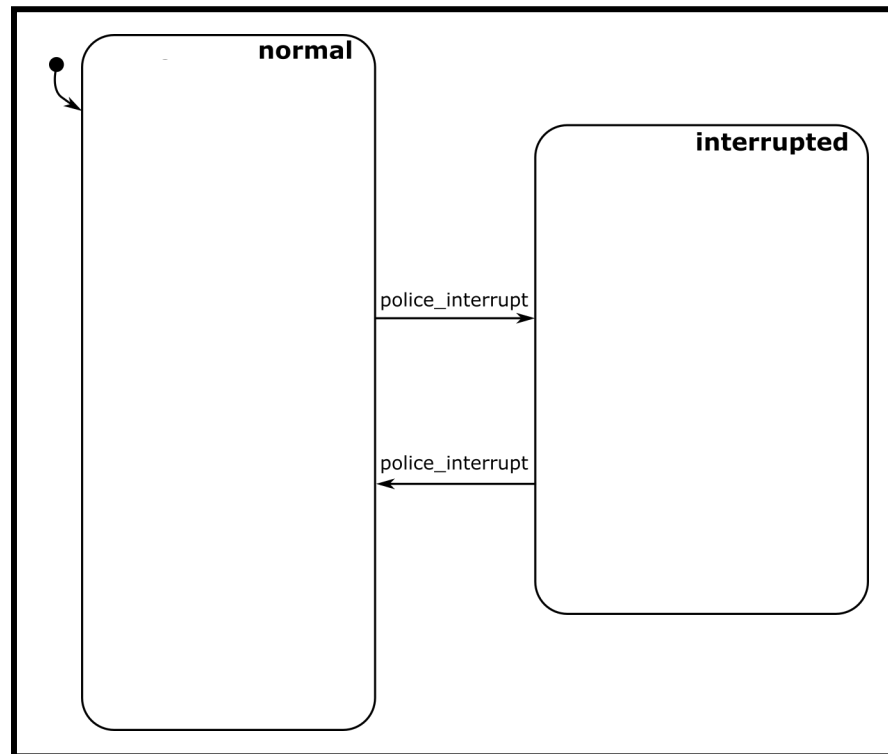
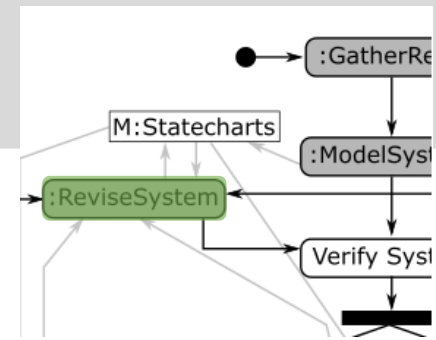

Exercise 5: Solution

- R7a: police can interrupt autonomous operation .
- R7b: autonomous operation can be interrupted during any phase of constant red, yellow and green lights.
- R7c: in interrupted mode the yellow light blinks with a constant frequency of 1 Hz (on 0.5s, off 0.5s).
- R8a: police can resume to regular autonomous operation.
- R8b: when regular operation is resumed, the traffic light restarts with red (R) light on.

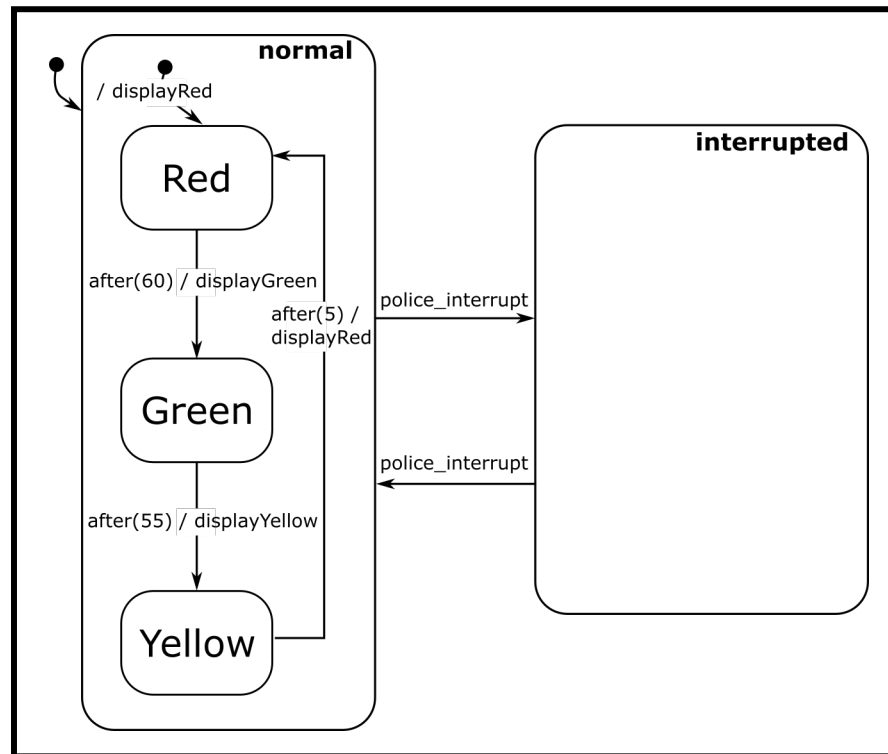
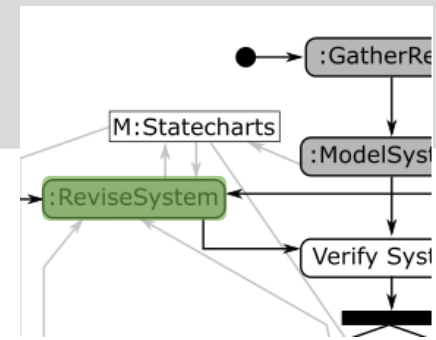

Exercise 5: Solution

- R7a: police can interrupt autonomous operation .
- R7b: autonomous operation can be interrupted during any phase of constant red, yellow and green lights.
- R7c: in interrupted mode the yellow light blinks with a constant frequency of 1 Hz (on 0.5s, off 0.5s).
- R8a: police can resume to regular autonomous operation.
- R8b: when regular operation is resumed, the traffic light restarts with red (R) light on.

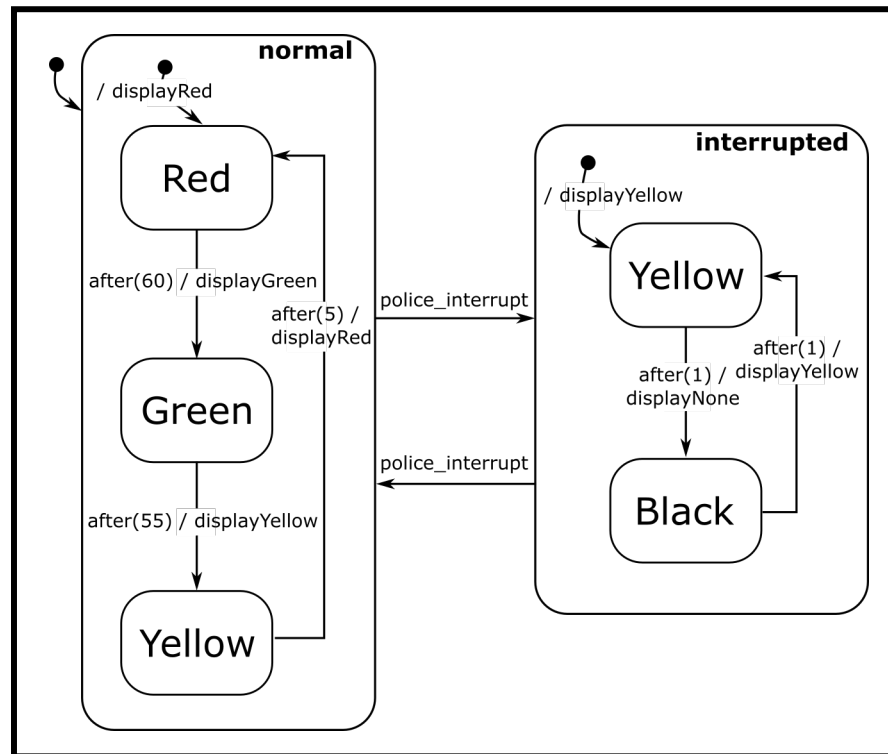
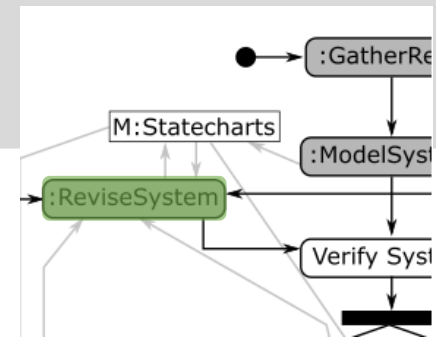

Exercise 5 - Solution

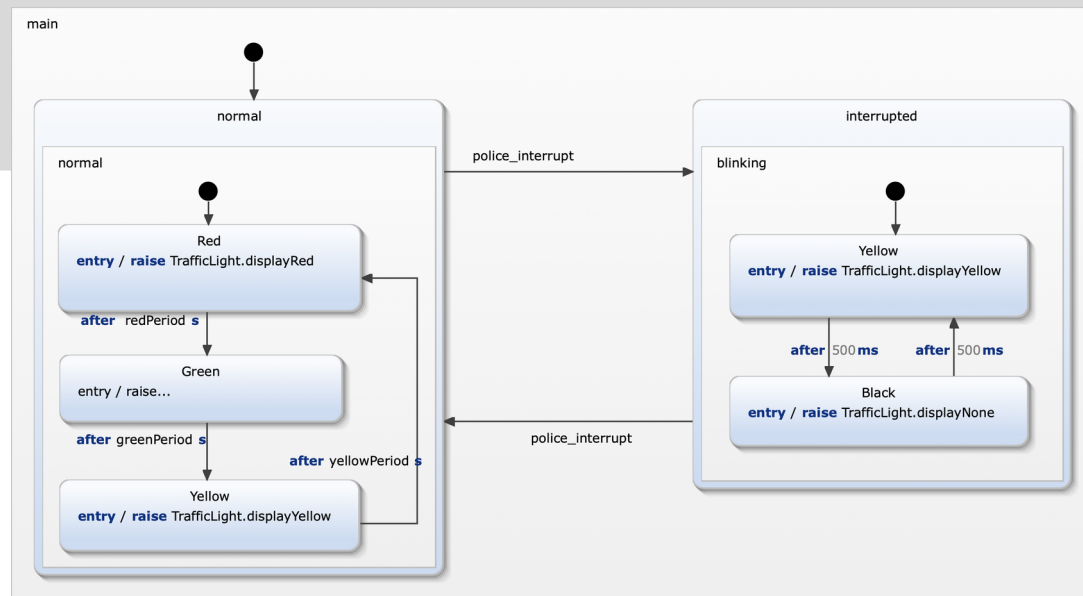

requirement	modelling approach
R6: police can interrupt autonomous operation.	An new incoming event <code>police_interrupt</code> triggers a transition to a new state <code>interrupted</code> .
R6a: autonomous operation can be interrupted during any phase of constant red, yellow and green lights.	The states <code>Red</code> , <code>Green</code> , and <code>Yellow</code> are grouped within a new composite state <code>normal</code> . This state is the source state of the transition to state <code>interrupted</code> and thus also applies to all substates.
R7: in <code>interrupted</code> mode the yellow light blinks with a constant frequency of 1 Hz. (on 0.5s, off 0.5s).	State <code>interrupted</code> is a composite state with two substates <code>Yellow</code> and <code>Black</code> . These switch the yellow light on and off. Timed transitions between these states ensure correct timing for blinking.
R8: police can resume to regular autonomous operation.	A transition triggered by <code>police_interrupt</code> leads from state <code>interrupted</code> to state <code>normal</code> .
R8a: when regular operation is resumed the traffic light restarts with red (R) light on.	When activating state <code>normal</code> its substate <code>Red</code> is activated by default.

History

History: pseudo-states



shallow history



deep history

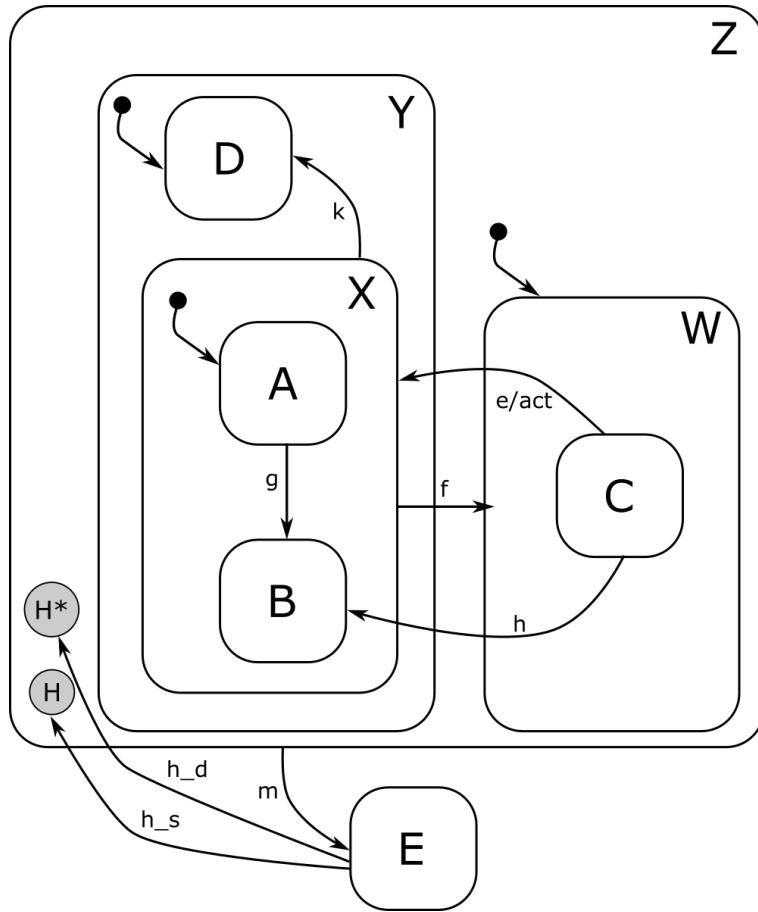

History: pseudo-states

\textcircled{H} shallow history $\textcircled{H^*}$ deep history

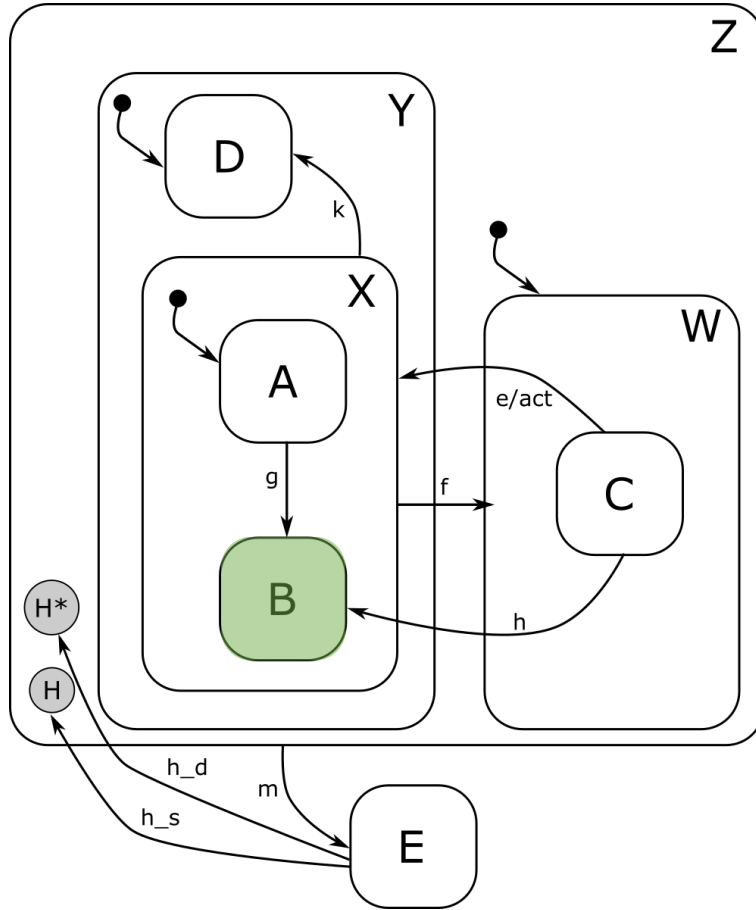

- Assume $Z/Y/X/B$ is active, and m is processed

History: pseudo-states

\textcircled{H} shallow history $\textcircled{H^*}$ deep history

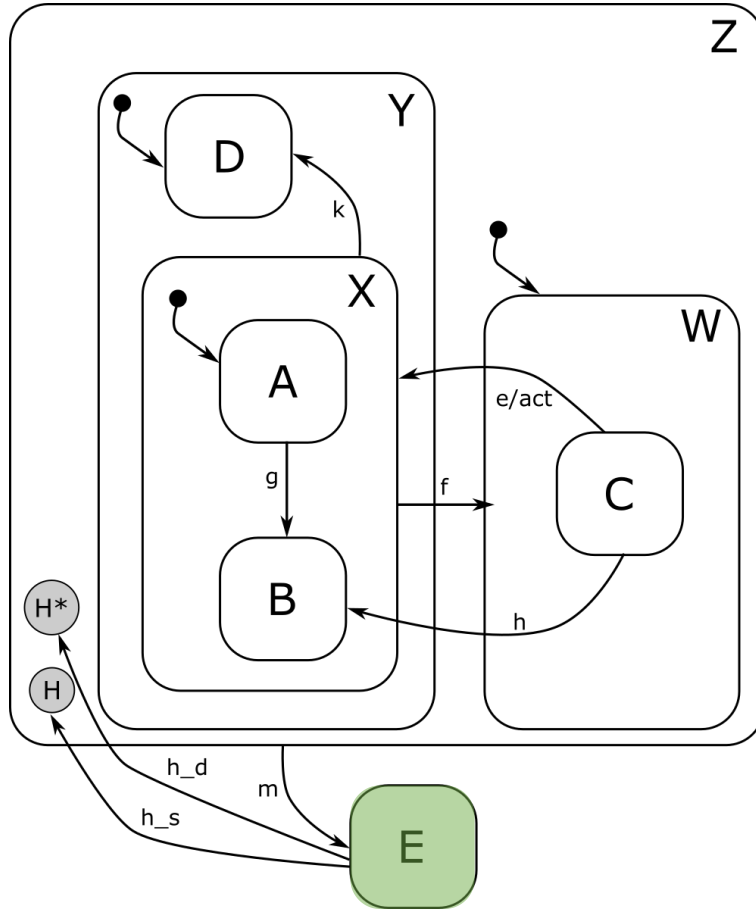

- Assume $Z/Y/X/B$ is active, and m is processed
 - Effective target state: E

History: pseudo-states



shallow history



deep history

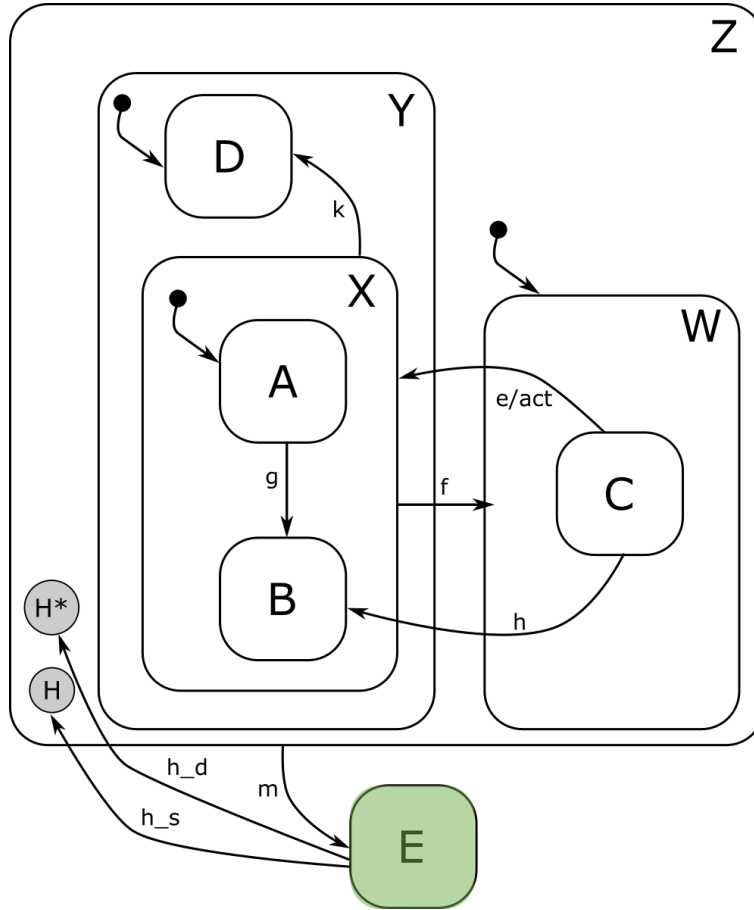

- Assume $Z/Y/X/B$ is active, and m is processed
 - Effective target state: E
- If h_s is processed

History: pseudo-states

\textcircled{H} shallow history $\textcircled{H^*}$ deep history

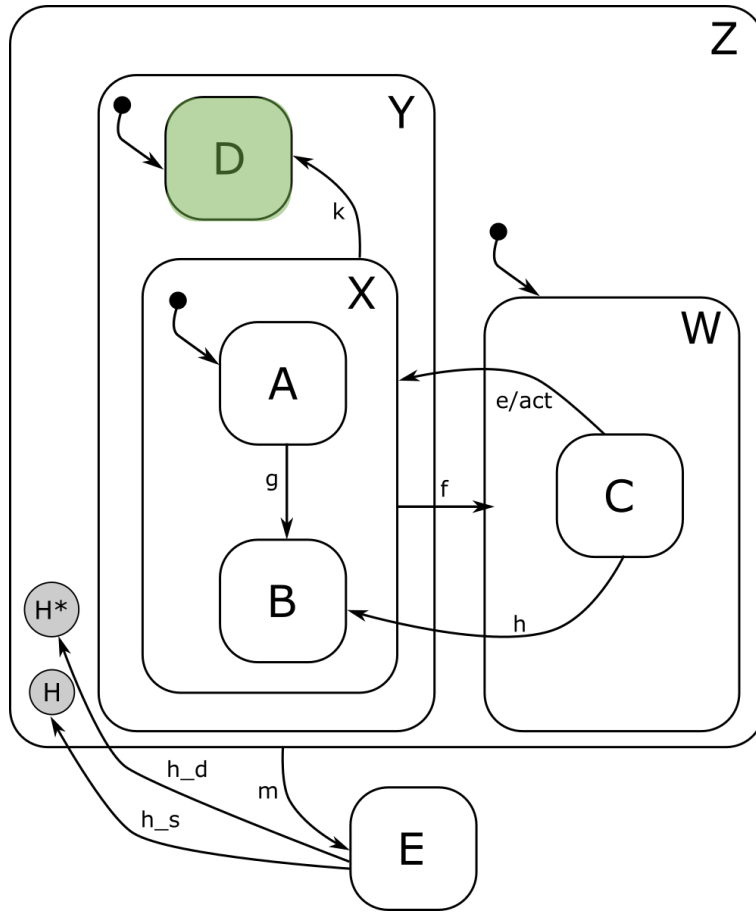

- Assume $Z/Y/X/B$ is active, and m is processed
 - Effective target state: E
- If h_s is processed
 - Effective target state: $Z/Y/D$

History: pseudo-states

\textcircled{H} shallow history $\textcircled{H^*}$ deep history

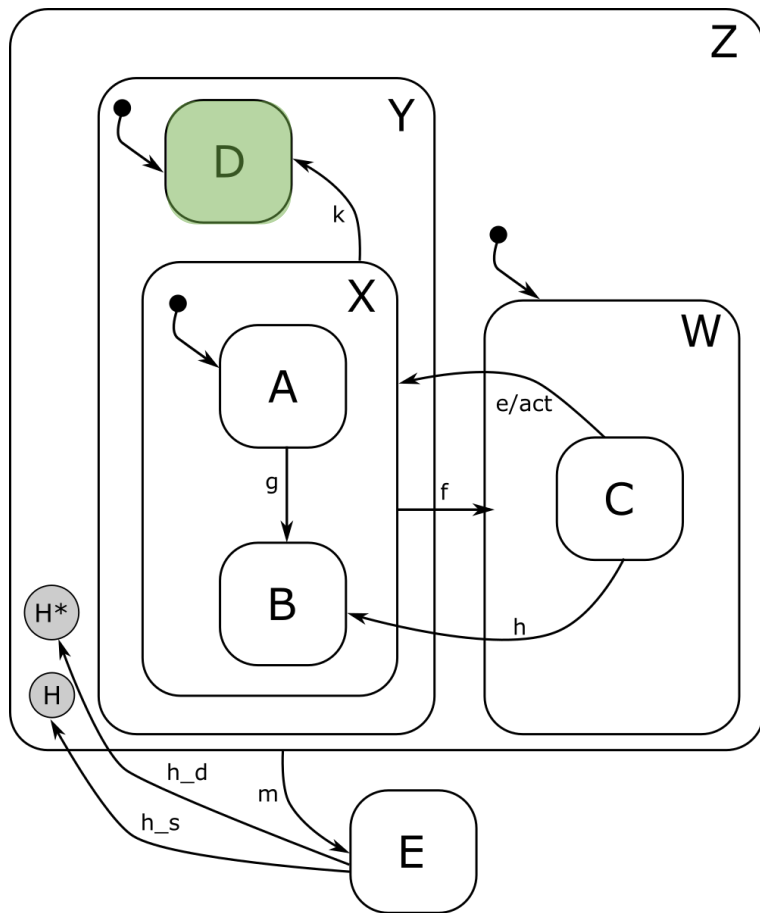

- Assume $Z/Y/X/B$ is active, and m is processed
 - Effective target state: E
- If h_s is processed
 - Effective target state: $Z/Y/D$
- If h_d is processed

History: pseudo-states

(H) shallow history (H*) deep history

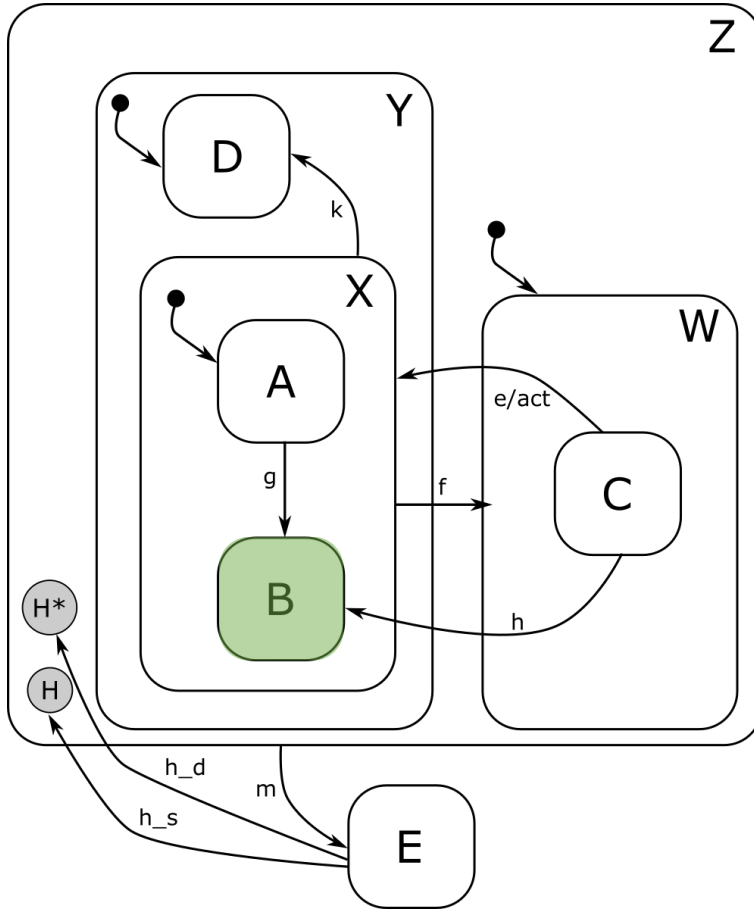

- Assume $Z/Y/X/B$ is active, and m is processed
 - Effective target state: E
- If h_s is processed
 - Effective target state: $Z/Y/D$
- If h_d is processed
 - Effective target state: $Z/Y/X/B$

History: pseudo-states

H shallow history
 H* deep history

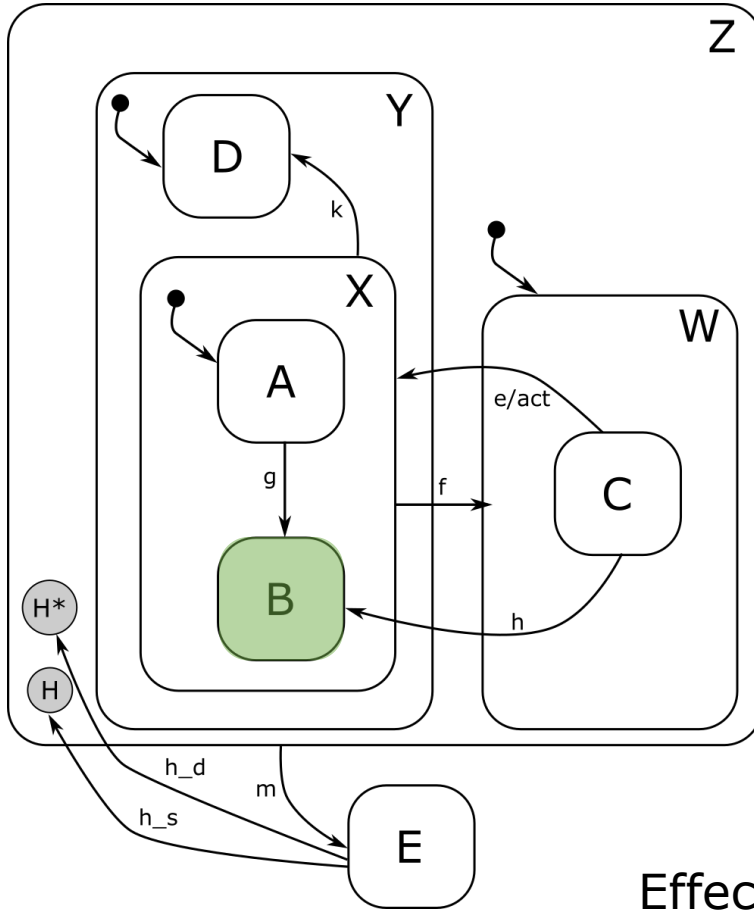

- Assume $Z/Y/X/B$ is active, and m is processed
 - Effective target state: E
- If h_s is processed
 - Effective target state: $Z/Y/D$
- If h_d is processed
 - Effective target state: $Z/Y/X/B$

Effective target states:

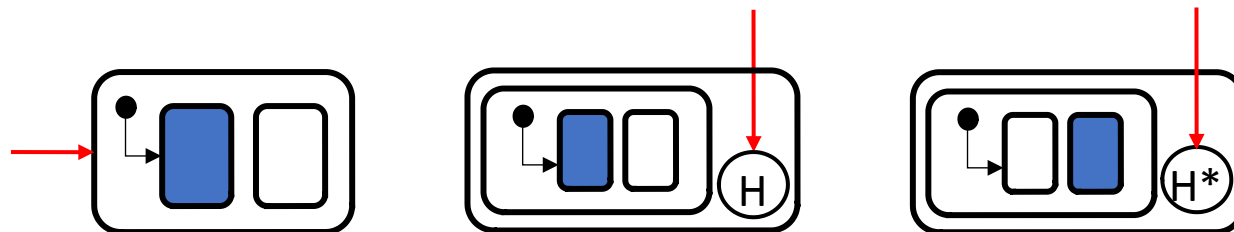

RECURSIVE!

Exercise 6

Model an interruptible
traffic light that restores
its state

Exercise 6: Requirements

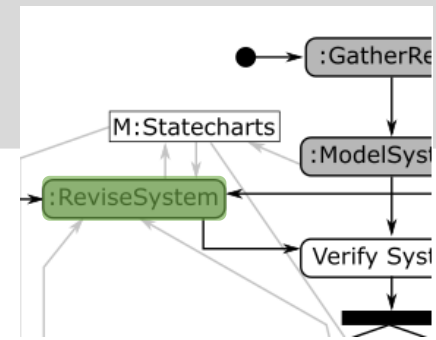

- R8b: when regular operation is resumed the traffic light restarts with the last active light color red (R), green (G), or yellow (Y) on.

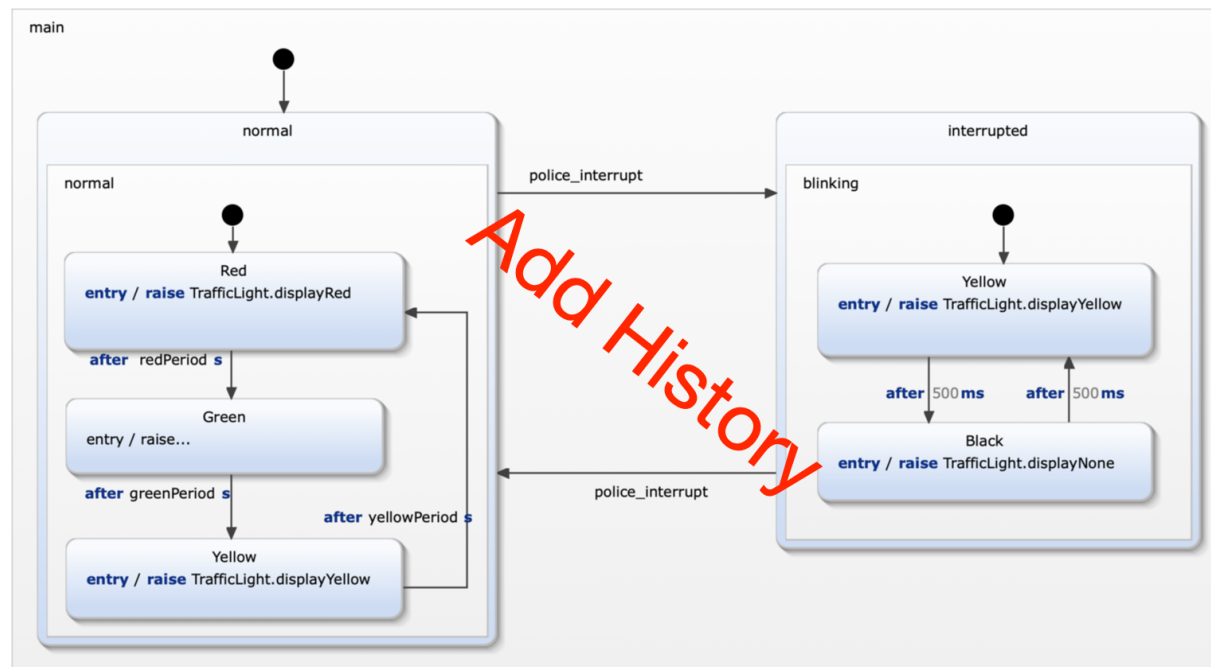

Exercise 6: Solution

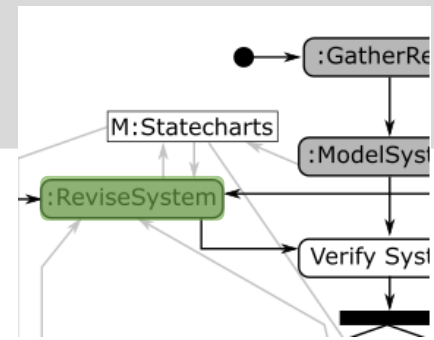

- R8b: when regular operation is resumed the traffic light restarts with the last active light color red (R), green (G), or yellow (Y) on.

Exercise 6: Solution

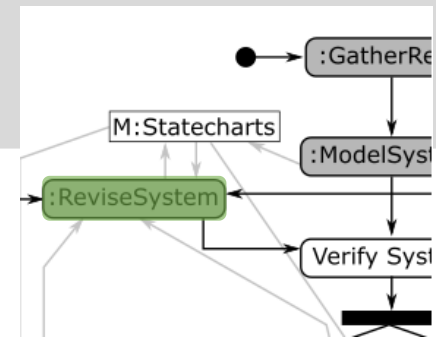

- R8b: when regular operation is resumed the traffic light restarts with the last active light color red (R), green (G), or yellow (Y) on.

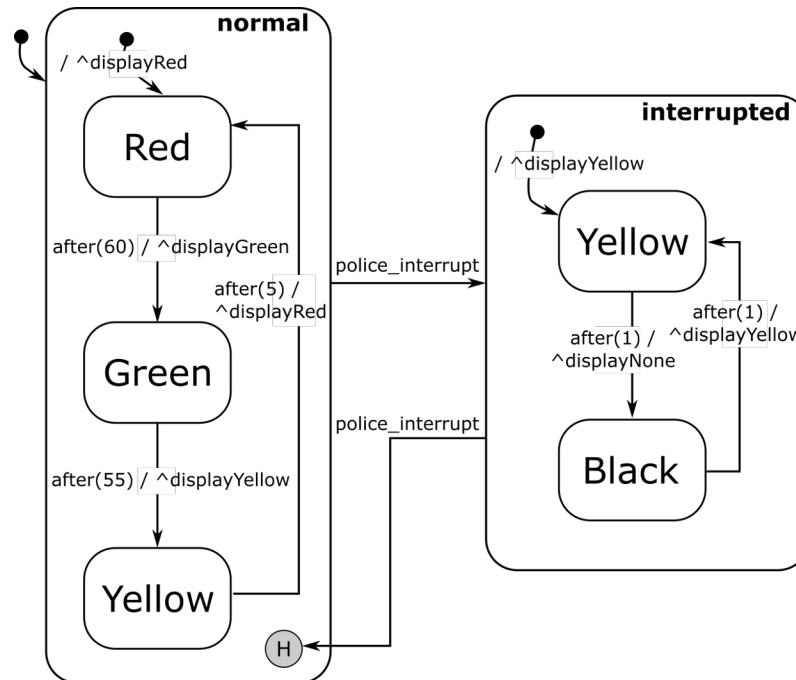

Exercise 7

Model an interruptible traffic light that restores its state and can be switched on/off

Exercise 7: Requirements

Add another level of hierarchy that supports switching on and off the entire traffic light. Go into detail with shallow and deep histories.

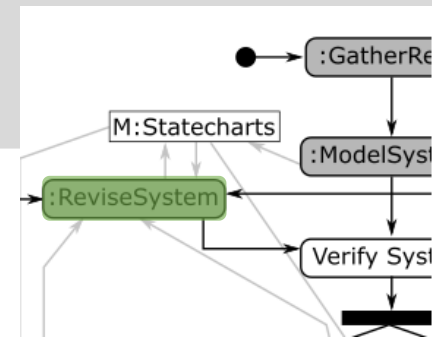

- R9: The traffic light can be switched on and off.
- R9a: The traffic light is initially off.
- R9b: If the traffic light is off none of its lights (R/G/Y) are on.
- R9c: After switching off and on again the traffic light must switch on the light that was on before the switching off.

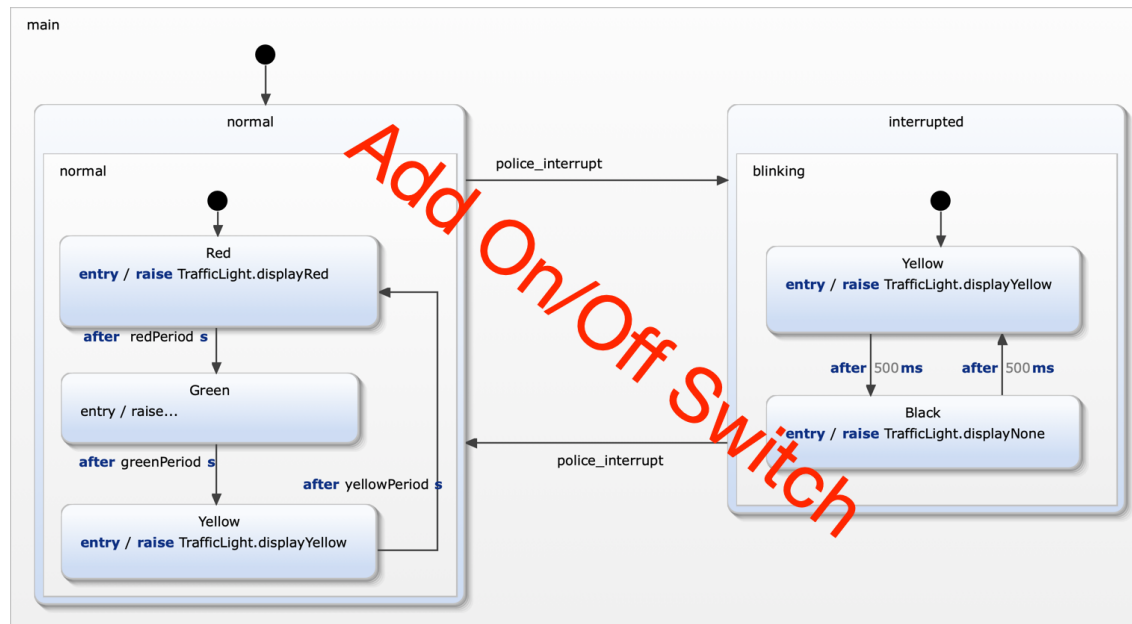

Exercise 7: Solution

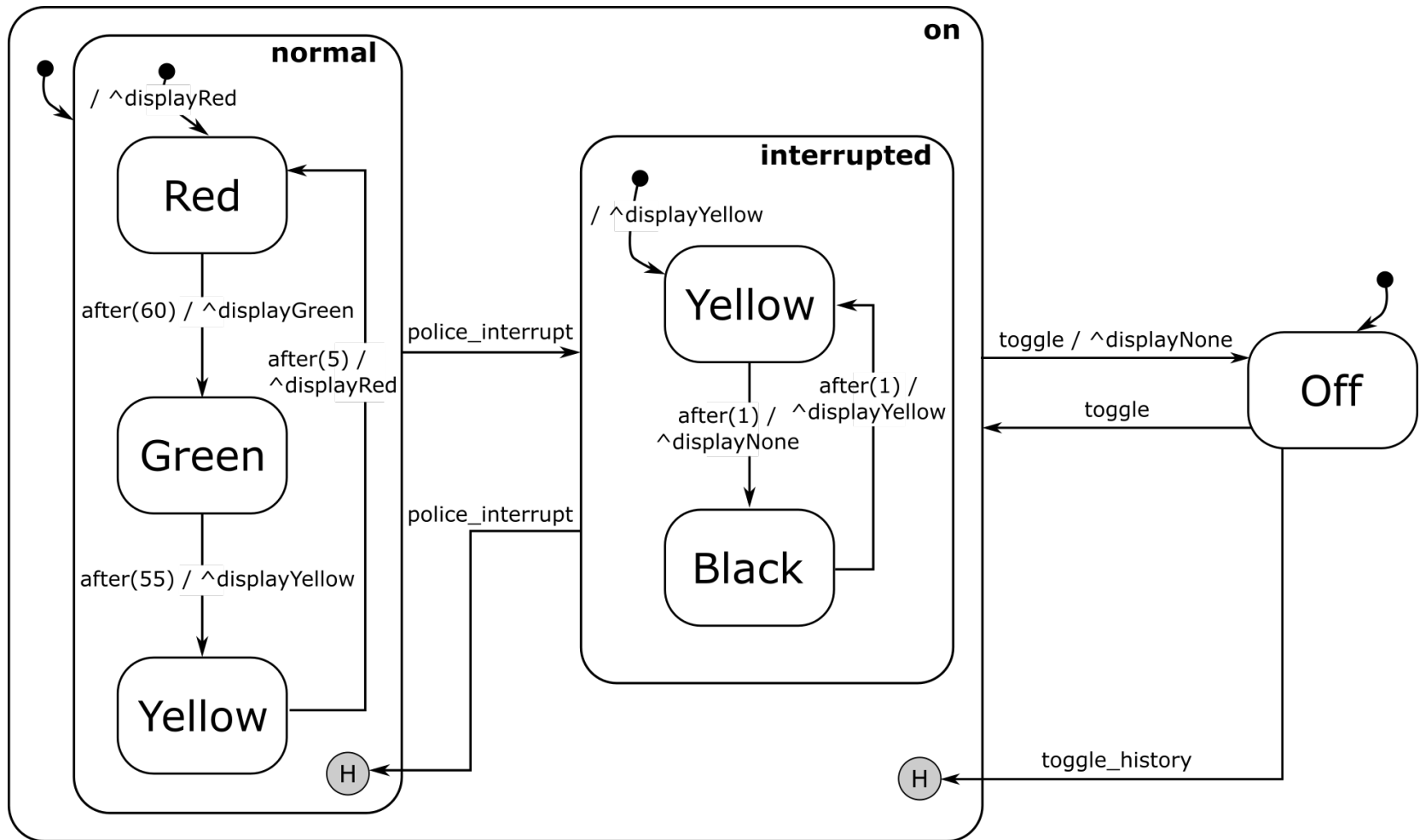

Exercise 7: Alternative Solution

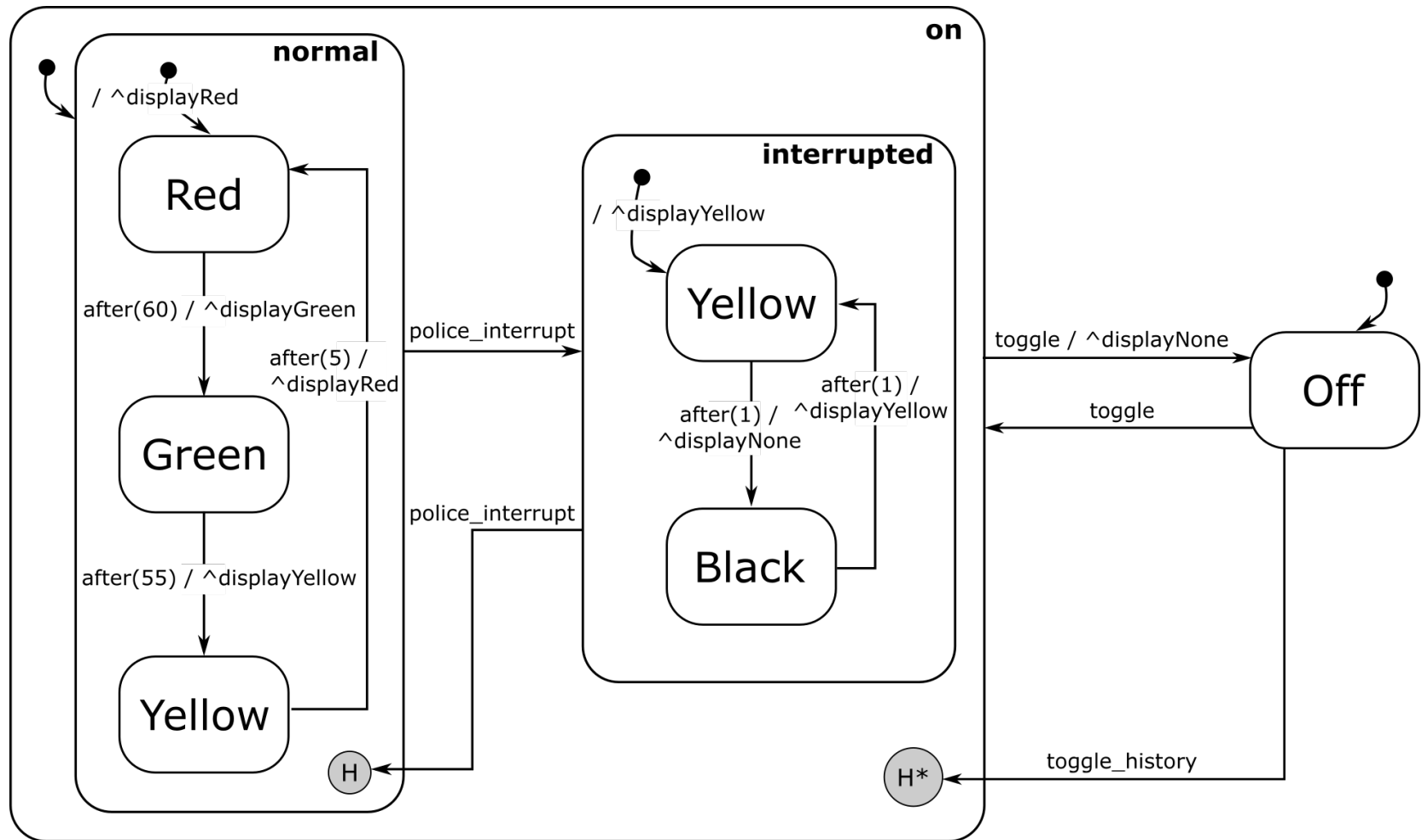

Orthogonality

Orthogonal Components/Regions: “and” states

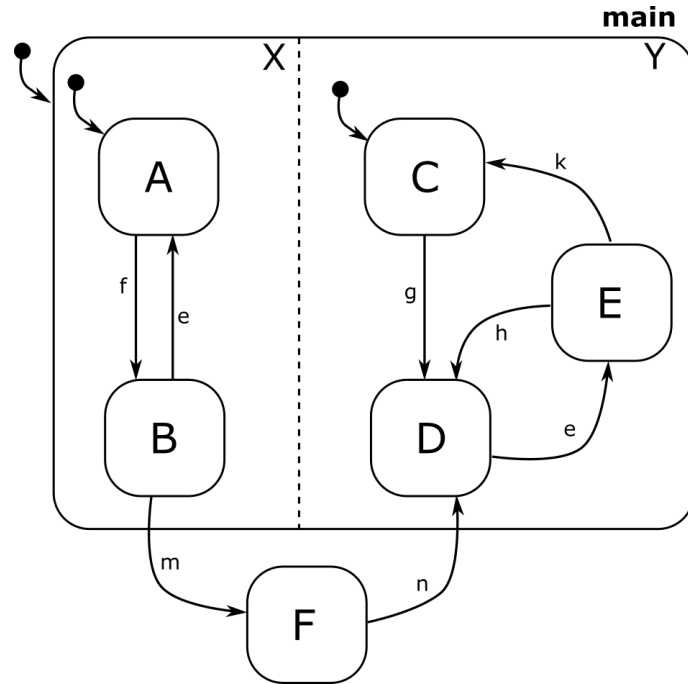

Orthogonal Components/Regions: “and” states

Semantics/Meaning?

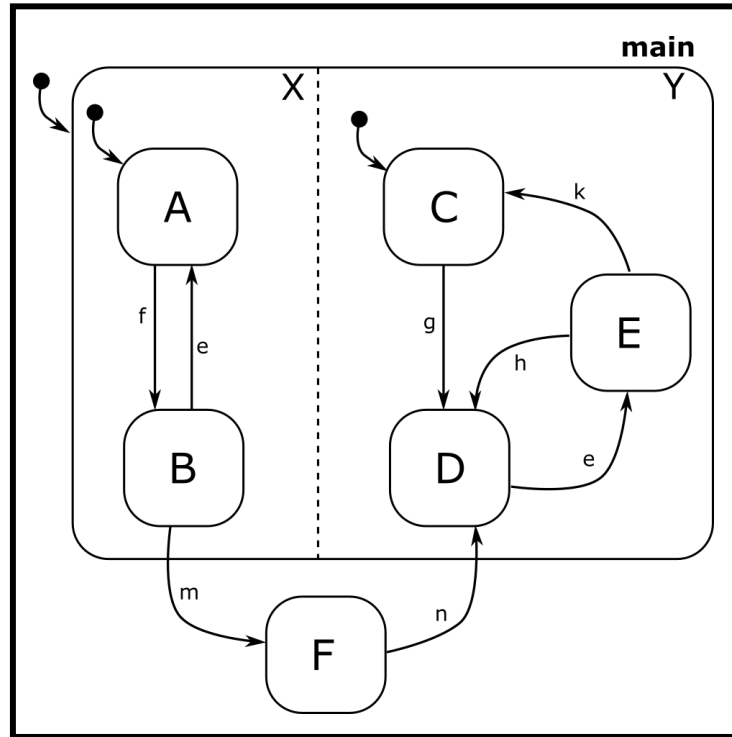

Orthogonal Components/Regions: "and" states

Semantics/Meaning?

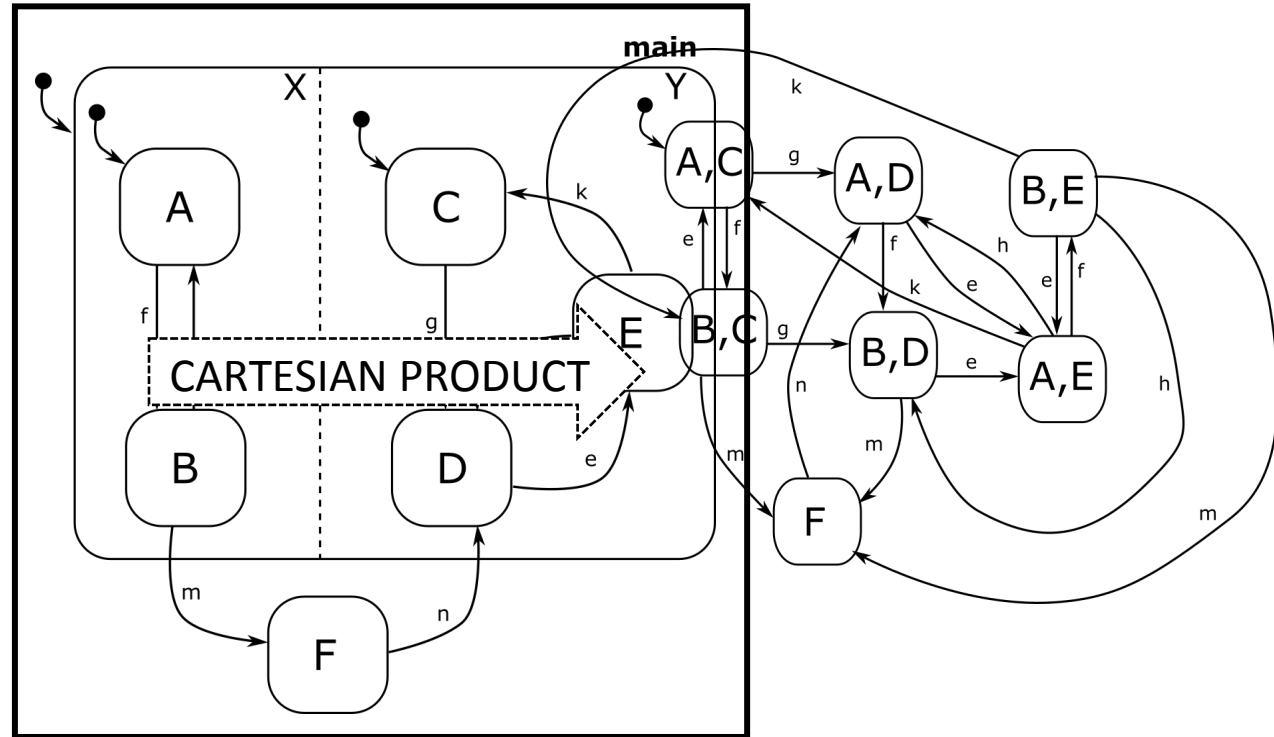

Orthogonal Components/Regions: "and" states

Semantics/Meaning?

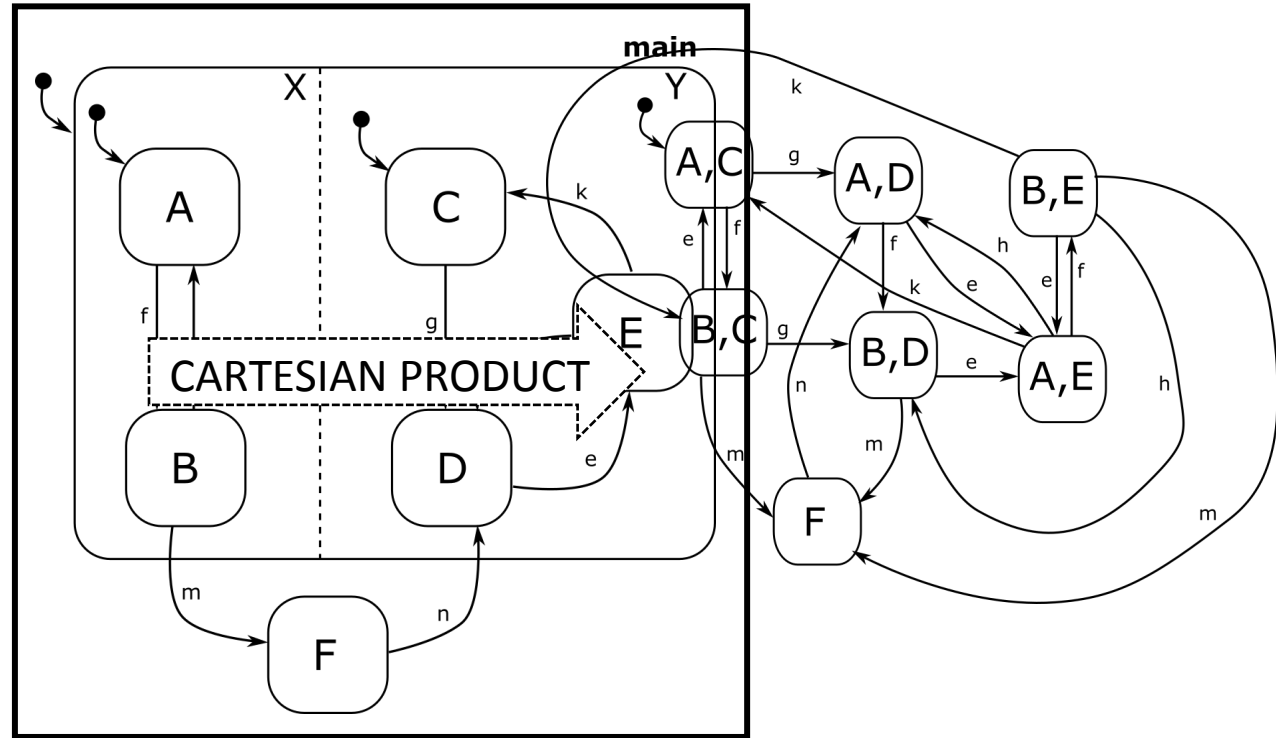

Effective target states:

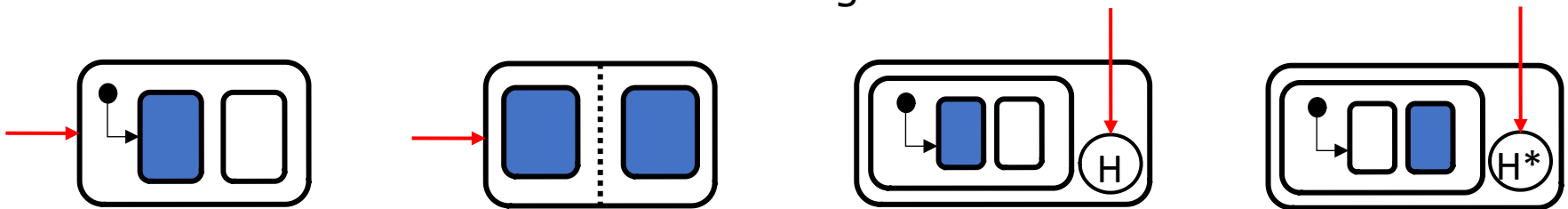

RECURSIVE!

Parallel (In)Dependence

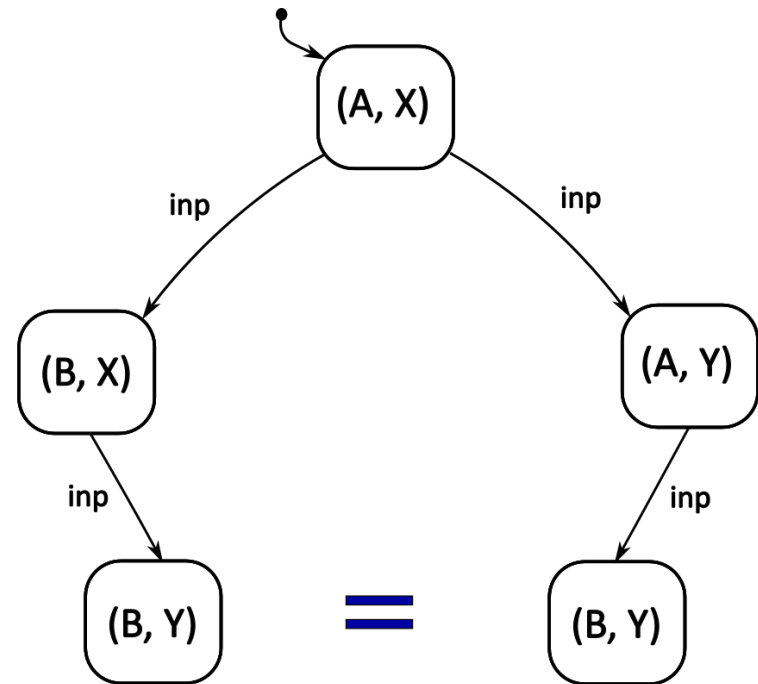
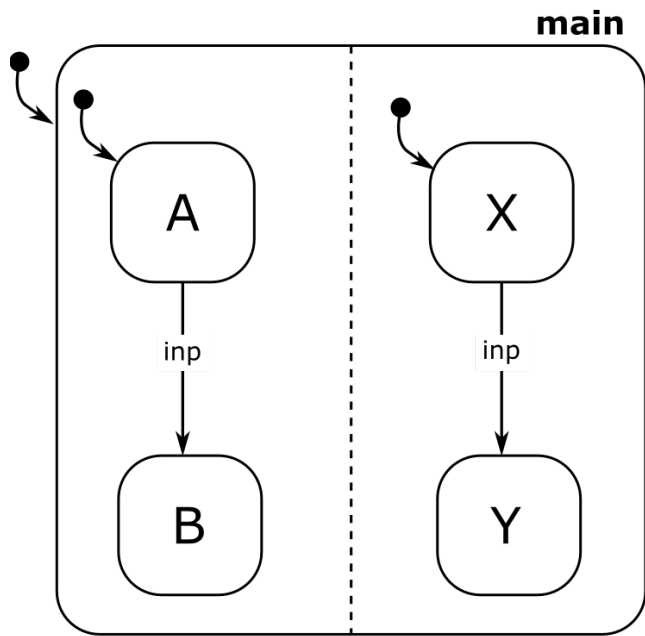

Parallel (In)Dependence

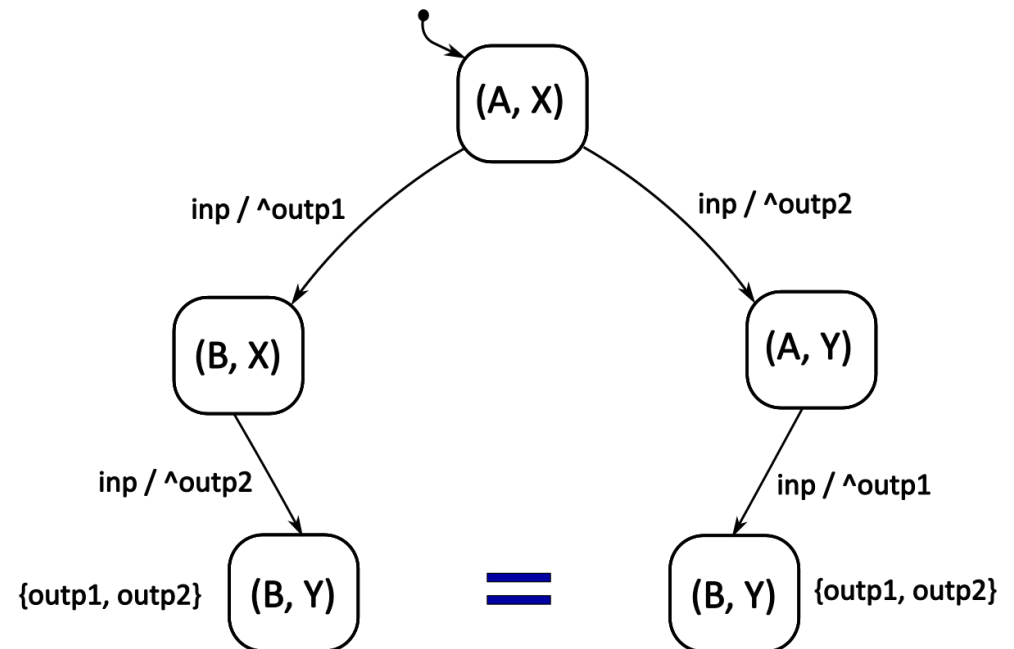
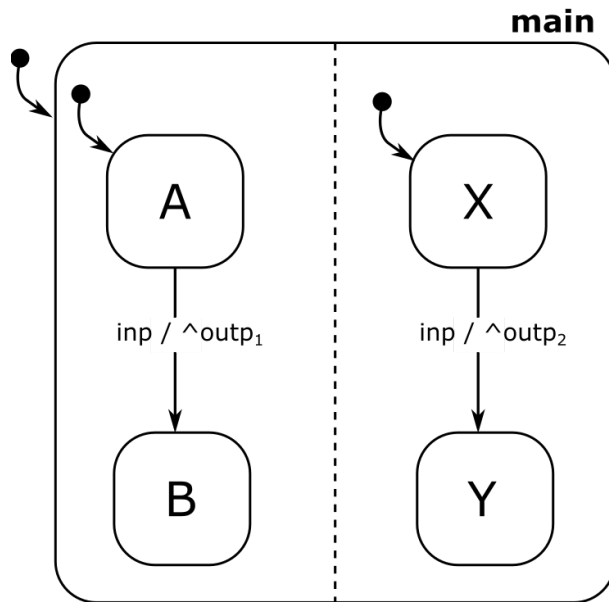

Parallel (In)Dependence

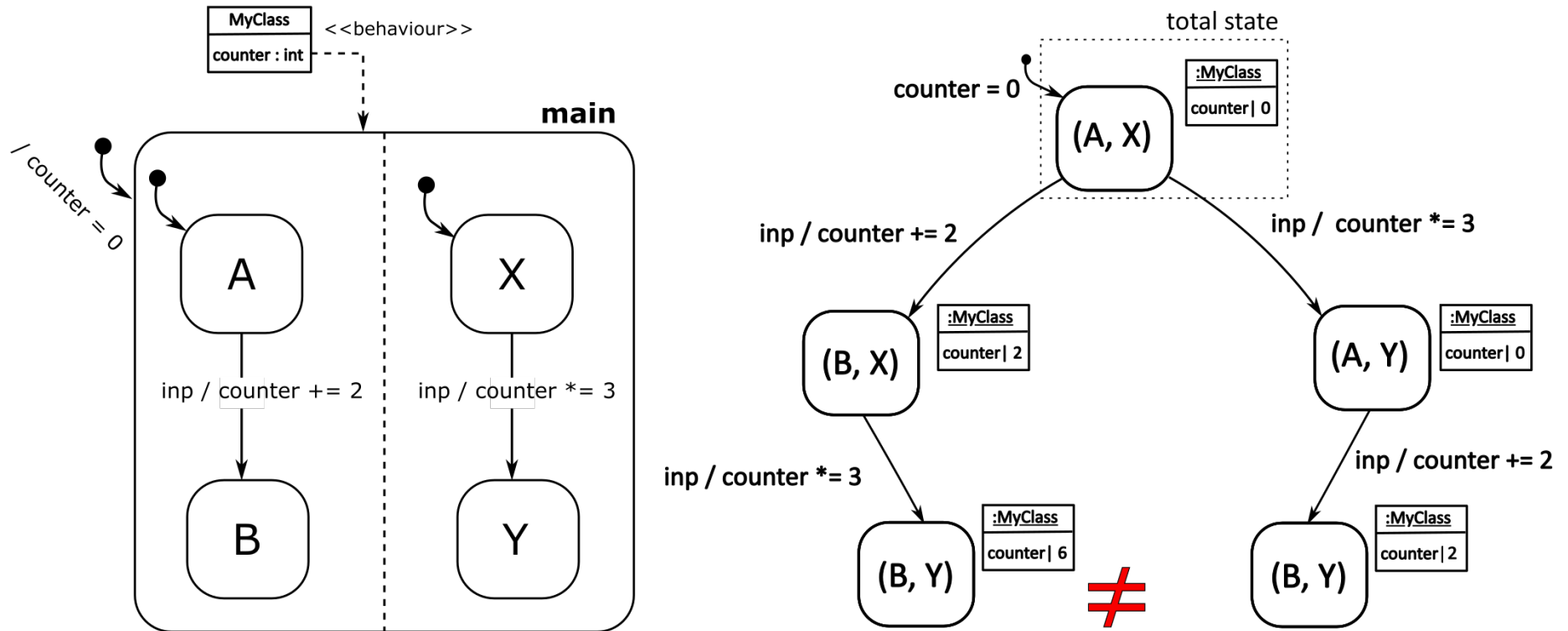

Orthogonality: Communication

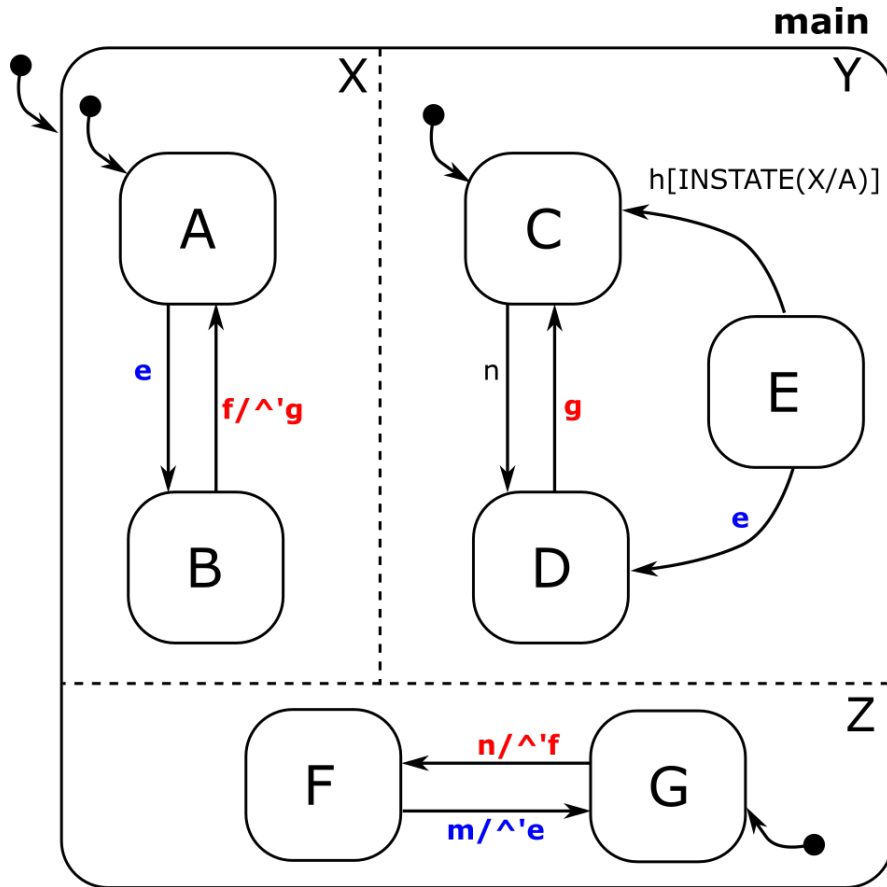

Input Segment: **nmnn**

Orthogonal Components can communicate:

- raising/broadcasting local events:
 $\wedge' \langle \langle \text{event name} \rangle \rangle$
- state reference is a transition guard:
INSTATE($\langle \langle \text{state location} \rangle \rangle$)

Simulation Algorithm

```
1  simulate(sc: Statechart) {
2      input_events = initialize_queue()
3      output_events = initialize_queue()
4      local_events = initialize_queue()
5      timers = initialize_set()
6      curr_state = get_effective_target_states(sc.initial_state)
7      for (var in sc.variables) {
8          var.value = var.initial_value
9      }
10     while (not finished()) {
11         curr_event = input_events.get()
12         for (region in sc.orthogonal_regions) {
13             enabled_transitions[region] = find_enabled_transitions(curr_state, curr_event, sc.variables)
14         }
15         while (not quiescent()) {
16             chosen_region = choose_one_region(sc.orthogonal_regions)
17             chosen_transition = choose_one_transition(enabled_transitions[chosen_region])
18             states_to_exit = get_states_to_exit(get_lca(curr_state, chosen_transition))
19             for (state_to_exit in states_to_exit) {
20                 cancel_timers(state_to_exit, timers)
21                 execute_exit_actions(state_to_exit)
22                 remove_state_from_curr_state(state_to_exit)
23             }
24             chosen_transition.action.execute(sc.variables, output_events, local_events)
25             states_to_enter = get_effective_target_states(chosen_transition)
26             for (state_to_enter in states_to_enter) {
27                 add_state_to_curr_state(state_to_enter)
28                 execute_enter_actions(state_to_enter)
29                 start_timers(state_to_enter, timers)
30             }
31             enabled_transitions = find_enabled_transitions(curr_state, sc.variables, local_events)
32         }
33     }
34 }
```

Conditional Transitions

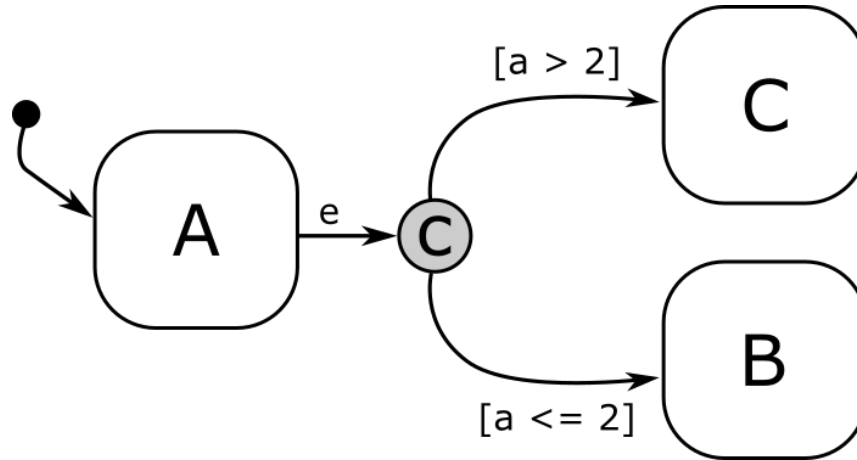

- `getEffectiveTargetStates()`: select one *True*-branch
- Conditions should not overlap to avoid non-determinism
 - in Yakindu, priority makes deterministic
 - “else” branch is required
- Equivalent (in this case) to two transitions:
 - $A - e[a > 2] \rightarrow C$
 - $A - e[a \leq 2] \rightarrow B$

Exercise 8

Add a timer
to the traffic light

Exercise 8: Requirements

In this exercise a timer must be modelled.
It introduces the use of orthogonal regions.

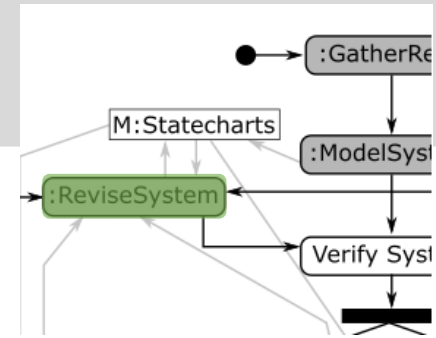

- R10a: A timer displays the remaining time while the light is red or green.
- R10b: This timer decreases and displays its value every second.
- R10c: The colour of the timer reflects the colour of the traffic light.

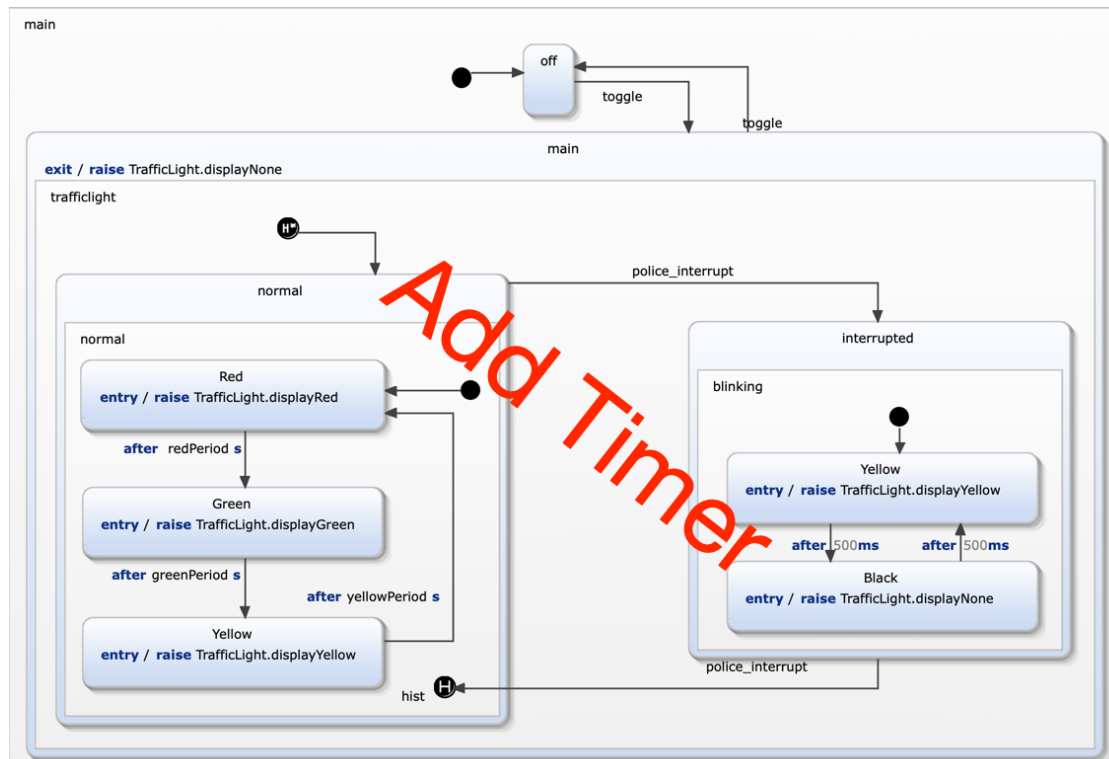

Exercise 8: Requirements

In this exercise a timer must be modelled. It introduces the use of orthogonal regions.

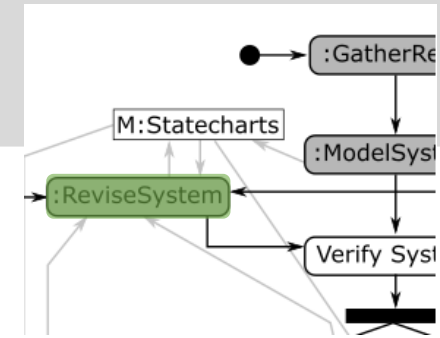
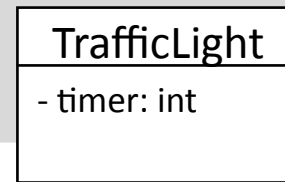

- R10a: A timer displays the remaining time while the light is red or green.
- R10b: This timer decreases and displays its value every second.
- R10c: The colour of the timer reflects the colour of the traffic light.

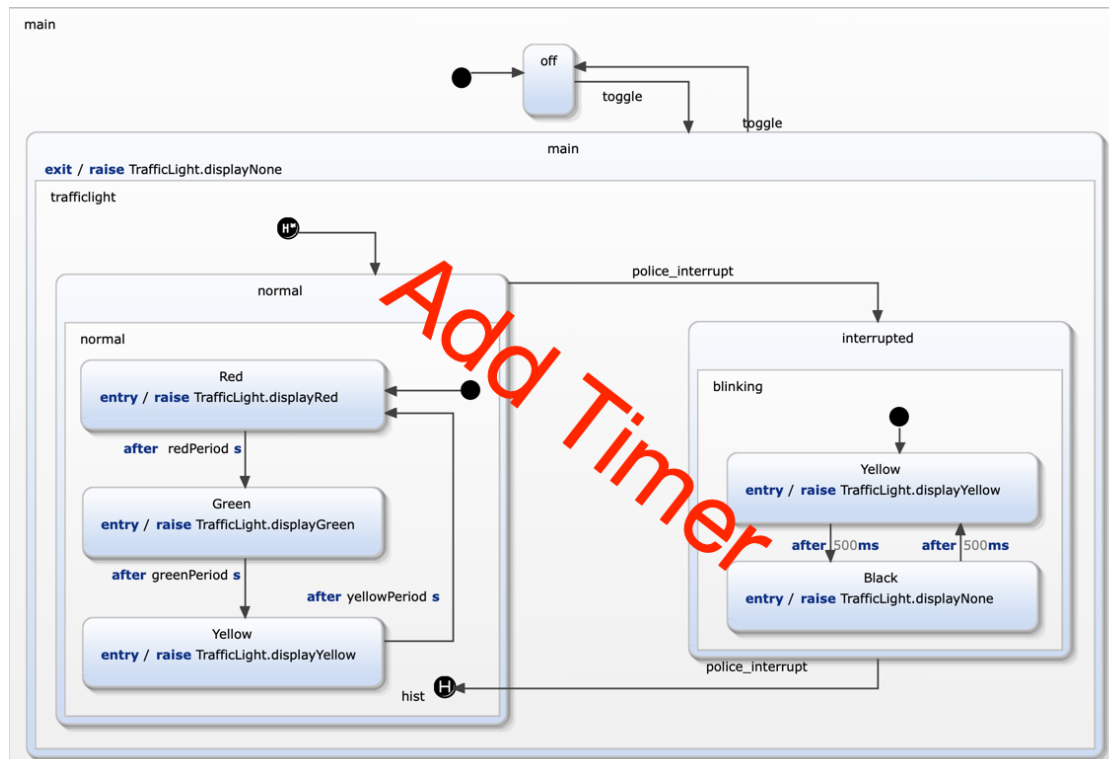

Exercise 8: Solution

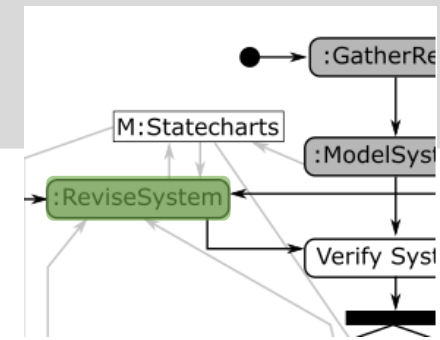
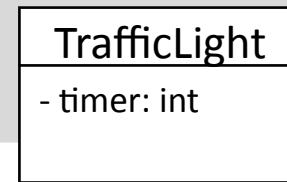

- R10a: A timer displays the remaining time while the light is red or green.
- R10b: This timer decreases and displays its value every second.
- R10c: The colour of the timer reflects the colour of the traffic light.

Exercise 8: Solution

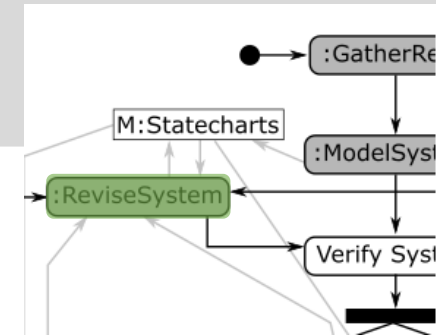
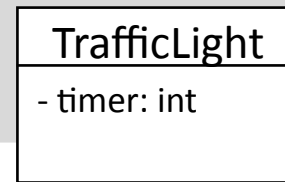

- R10a: A timer displays the remaining time while the light is red or green.
- R10b: This timer decreases and displays its value every second.
- R10c: The colour of the timer reflects the colour of the traffic light.

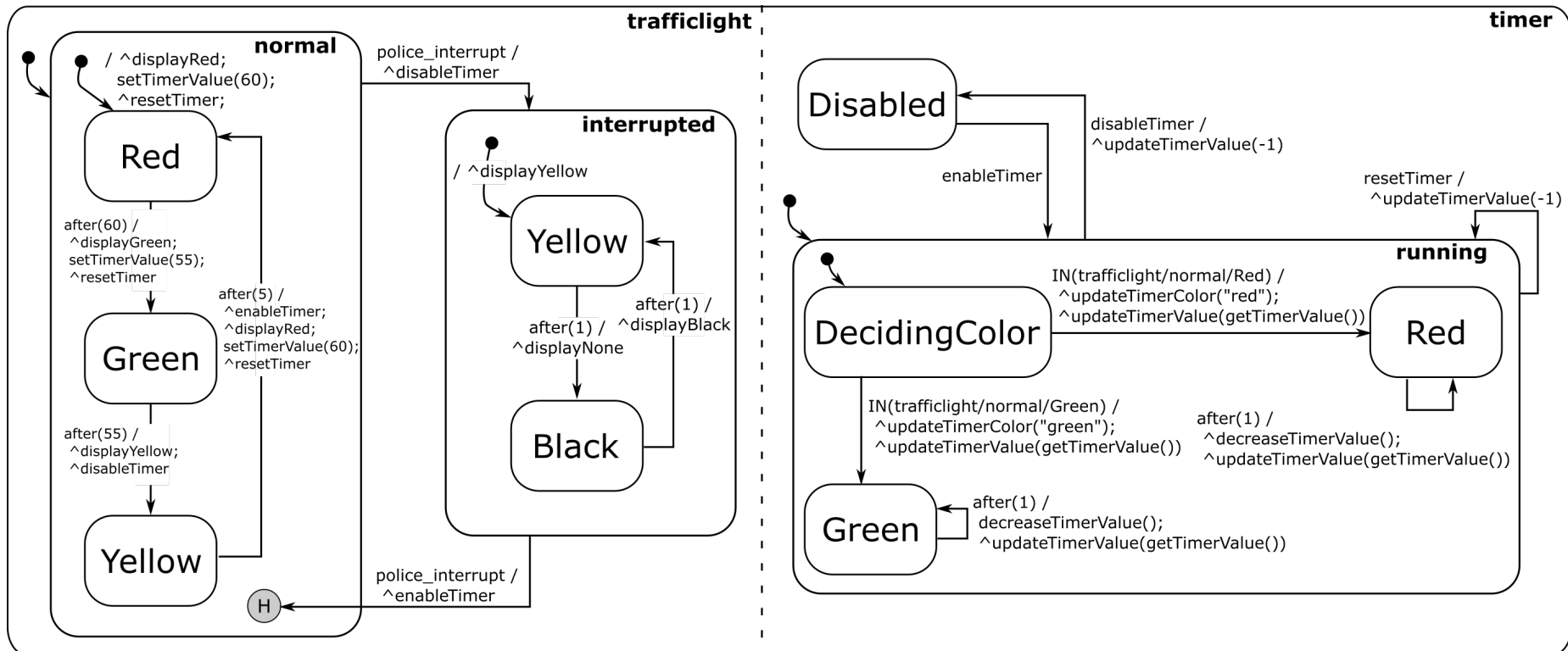

Solution 8

requirement	modelling approach
<p>R10: a timer displays the remaining time while the light is red or green</p>	<p>The timer is defined in a second region within state on (main in the Yakindu model).</p>
<p>R10a: This timer decreases and displays its value every second.</p>	<p>An internal variable for the counter is introduced. When switching the traffic light phase, the counter value is set to how long the light has been in that phase. Additionally, the local events <code>resetTimer</code>, <code>enableTimer</code>, and <code>disableTimer</code> are used to synchronize traffic light phase switches with the timer.</p>
<p>R10b: The colour of the timer reflects the colour of the traffic light.</p>	<p>When the timer is enabled it checks the active traffic light phase using the <code>active()</code> function.</p>

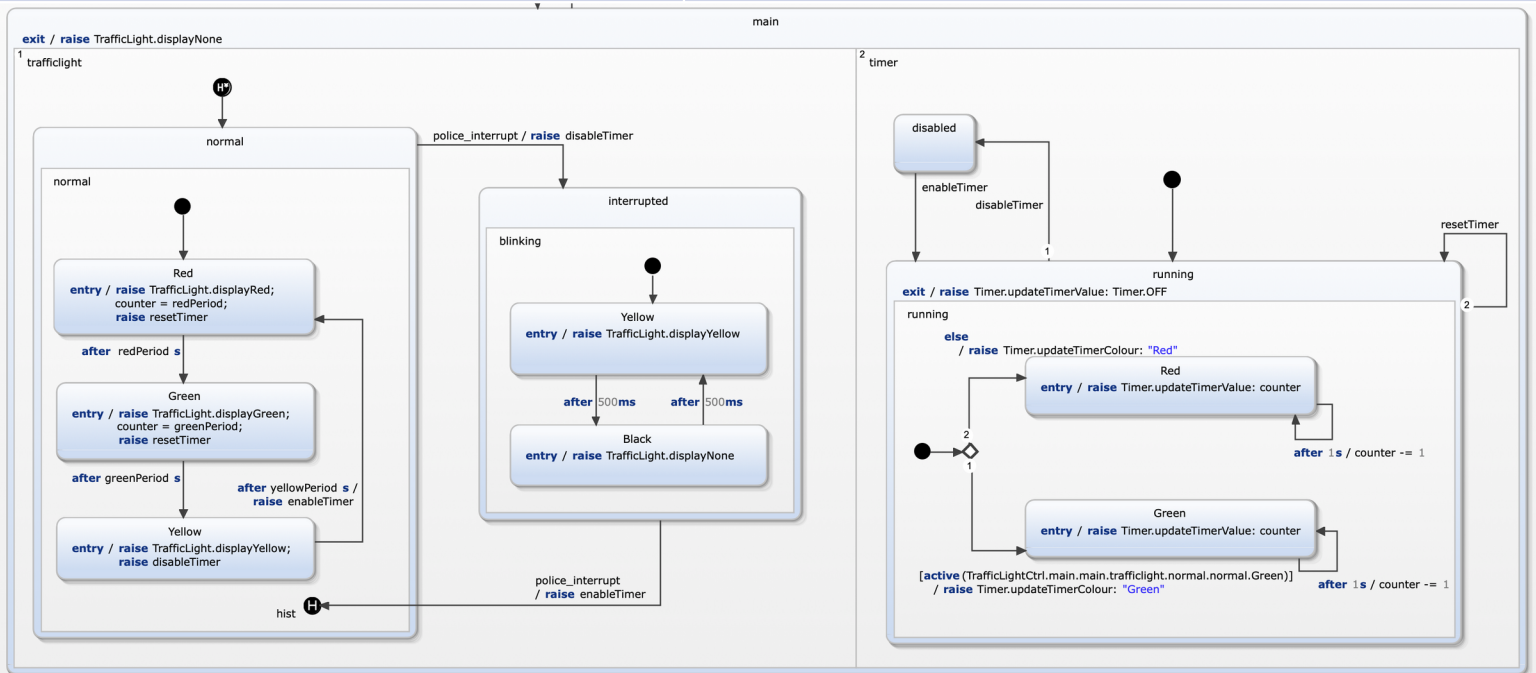

Yakindu syntax

Yakindu:

- **raise** e == ^e

- strict alternation between “or” and “and” states →

TrafficLightCtrl.**main.main**.trafficlight.**normal.normal**.Green

- **active()** == INSTATE() == IN()

Code Generation



- Code generators for C, C++, Java, Python, Swift, Typescript, SCXML
- Plain-code approach by default
- Very efficient code
- Easy integration of custom generators



Python



JavaScript



Code Generation

- Various different approaches for implementing a state machine (switch / case, state transition table, state pattern)
- Which one is the best depends on
 - Runtime (performance) requirements
 - ROM vs. RAM memory
 - Debugging capabilities
 - Clarity and maintainability

Switch / Case

- Each state corresponds to one case
- Each case executes state-specific statements and state transitions

```
public void stateMachine() {
    while (true) {
        switch (activeState) {
            case RED: {
                activeState = State.RED_YELLOW;
                break;
            }
            case RED_YELLOW: {
                activeState = State.GREEN;
                break;
            }
            case GREEN: {
                activeState = State.YELLOW;
                break;
            }
            case YELLOW: {
                activeState = State.RED;
                break;
            }
        }
    }
}
```

State Transition Table

- Specifies the state machine purely declaratively.
- One of the dimensions indicates current states, while the other indicates events.

```
enum columns {
    SOURCE_STATE,
    USER_UP, USER_DOWN, POSSENSOR_UPPER_POSITION, POSSENSOR_LOWER_POSITION,
    TARGET_STATE
};

#define ROWS 7
#define COLS 6
int state_table[ROWS][COLS] = {
    /*      source,      up,      down,  upper,  lower,  target */
    { INITIAL,  false, false, false, false, IDLE },
    { IDLE,     true,  false, false, false, MOVING_UP },
    { IDLE,     false, true,  false, false, MOVING_DOWN },
    { MOVING_UP, false, true,  false, false, IDLE },
    { MOVING_UP, false, false, true,  false, IDLE },
};
```

State Pattern

- Object-oriented implementation, behavioural design pattern
- Used by several frameworks like Spring StateMachine, Boost MSM or Qt State Machine Framework
- Each State becomes a class, events become methods
- All classes derive from a common interface

```
public class MovingUp extends AbstractState {  
  
    public MovingUp(StateMachine stateMachine) {  
        super(stateMachine);  
    }  
  
    @Override  
    public void raiseUserDown() {  
        stateMachine.activateState(new Idle(stateMachine));  
    }  
  
    @Override  
    public void raisePosSensorUpperPosition() {  
        stateMachine.activateState(new Idle(stateMachine));  
    }  
  
    @Override  
    public String getName() {  
        return "Moving up";  
    }  
  
}
```

Hierarchy: outer vs. inner

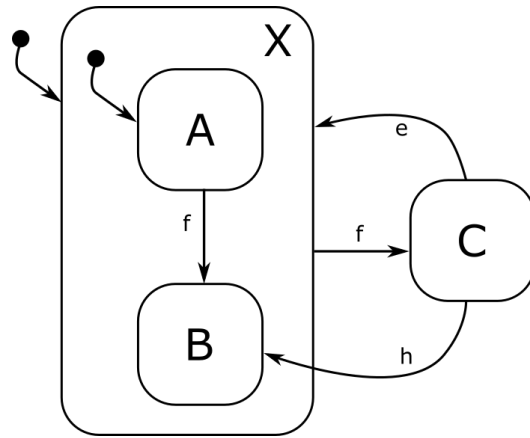

Hierarchy: outer vs. inner

Semantics/Meaning?

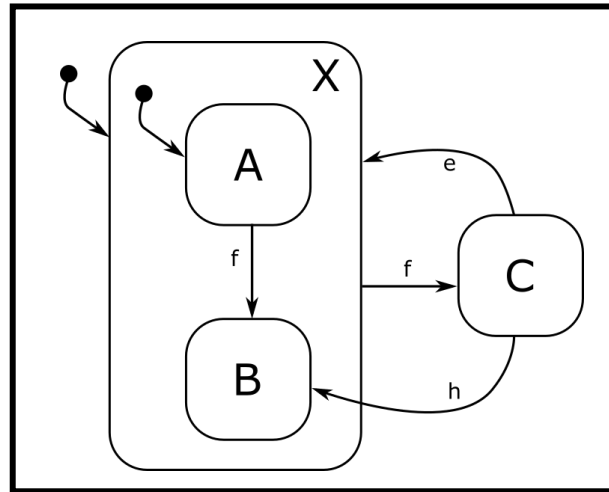

Hierarchy: outer vs. inner

Semantics/Meaning?

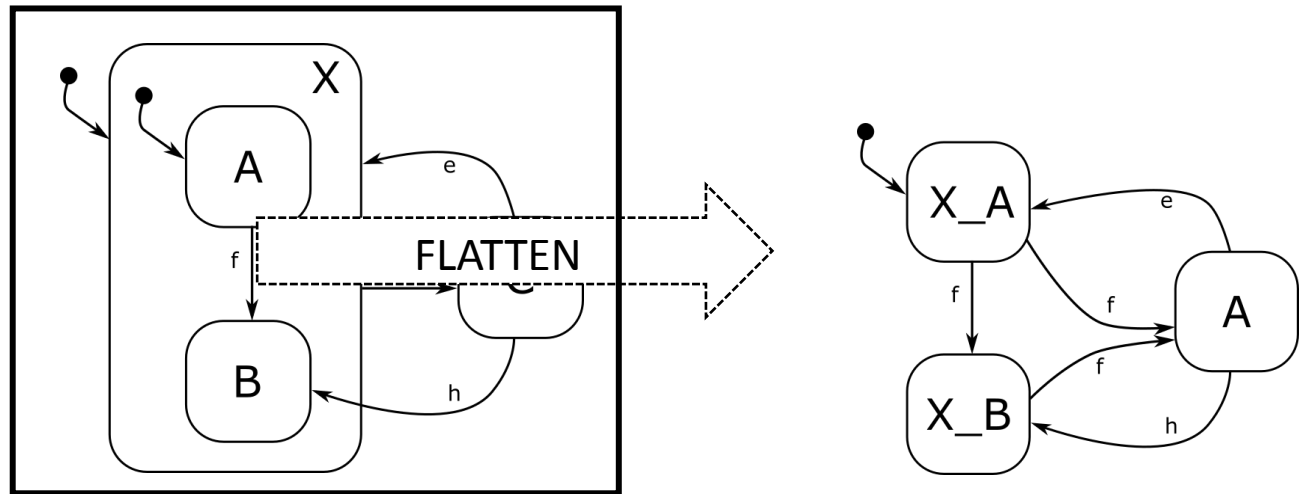

Hierarchy: outer vs. inner

Semantics/Meaning?

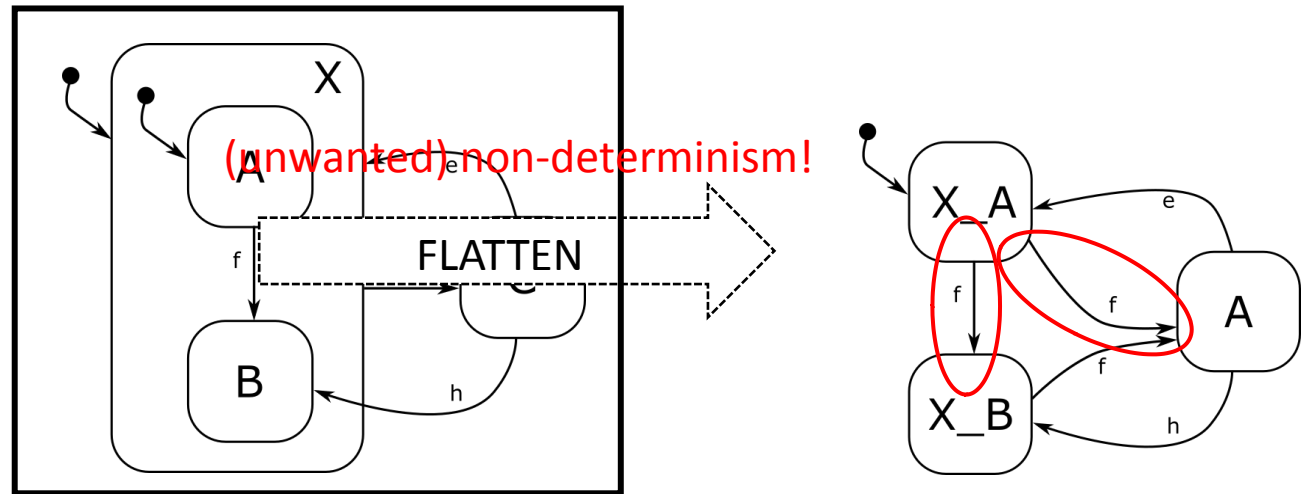

Hierarchy: outer vs. inner

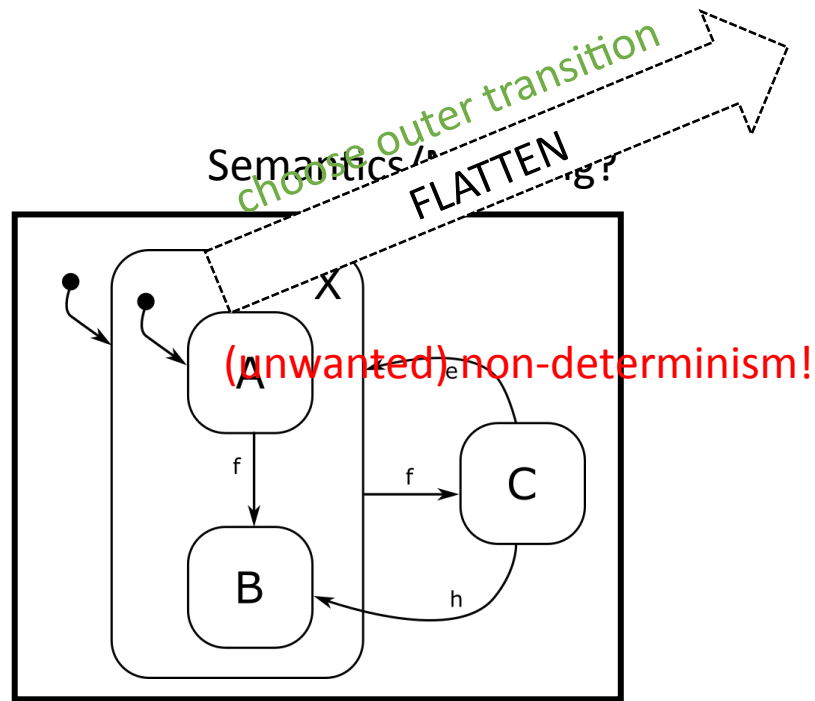

Statemate, Yakindu, ...

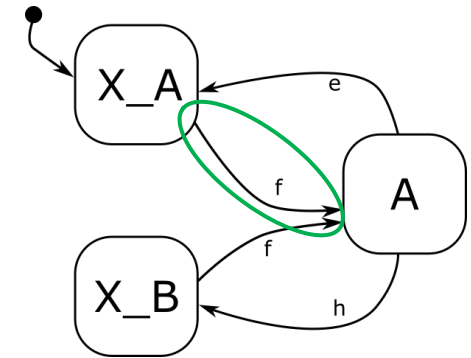

Hierarchy: outer vs. inner

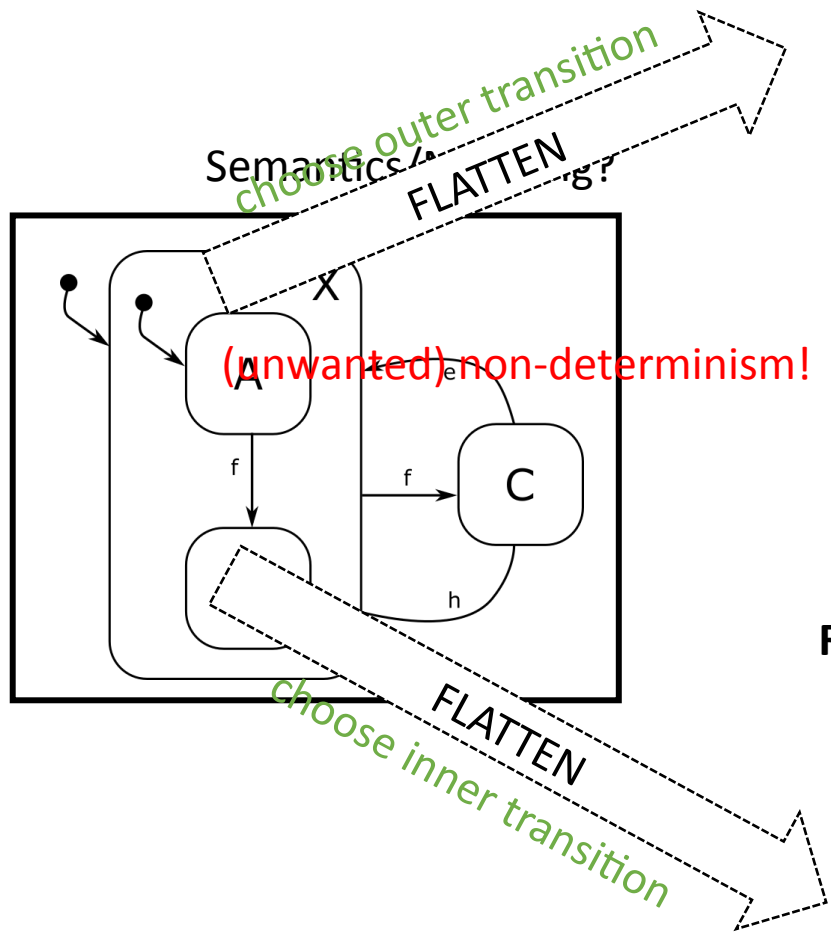

Statemate, Yakindu, ...

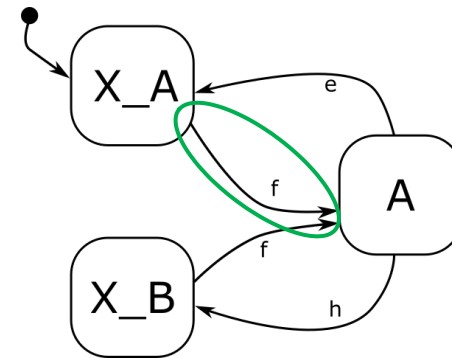

Rhapsody, ...

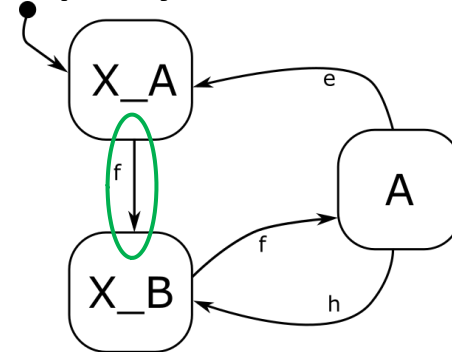

Hierarchy: outer vs. inner

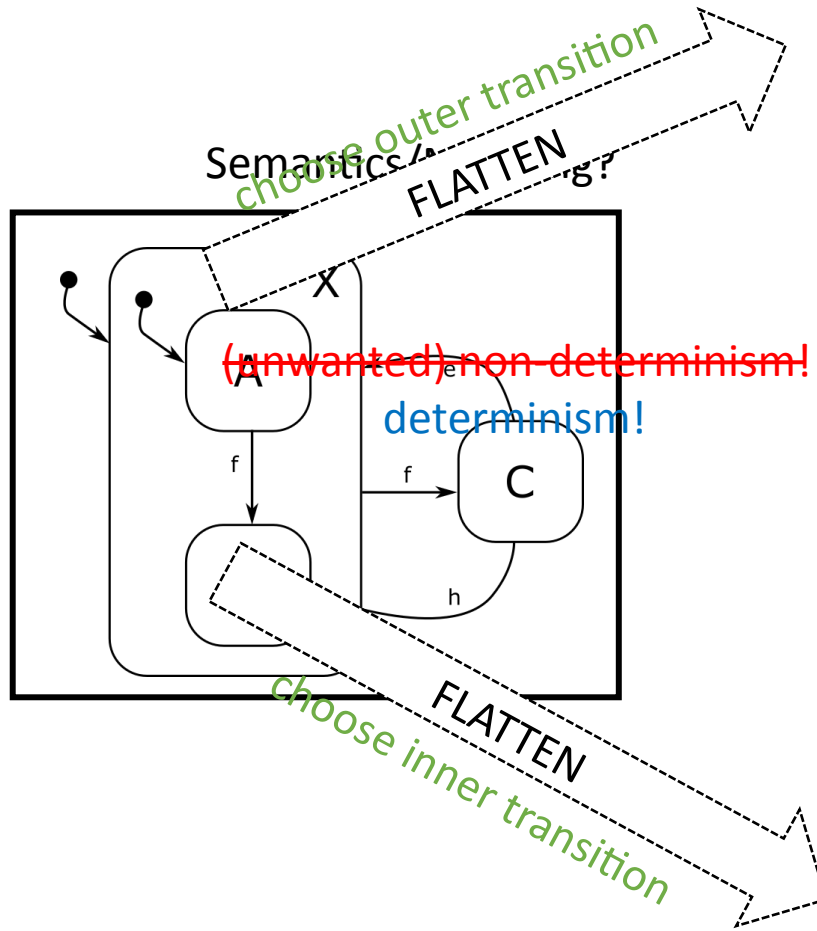

Statemate, Yakindu, ...

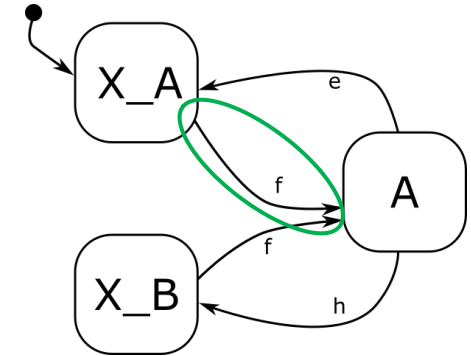



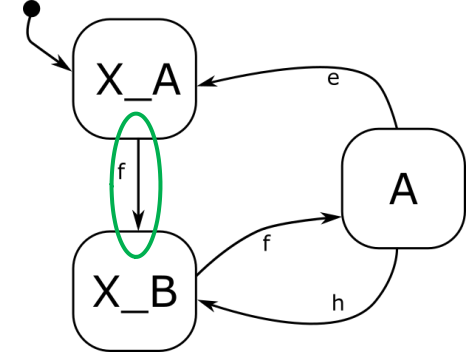









Rhapsody, ...



Hierarchy: why inner?

Code Generation

	Fast	Memory efficient	easy to debug	Easy to understand
 Switch / Case				
State Transition Table				
State Pattern				



very simplified illustration



Code Generator Model

```
GeneratorModel for yakindu::java {  
  statechart exercise5 {  
    feature Outlet {  
      targetProject = "5_sctunit"  
      targetFolder = "src-gen"  
      libraryTargetFolder = "src"  
    }  
  }  
}
```

- Has a generator ID
- Has a generator entry
- Each generator entry contains 1..n feature-configurations
- Each feature-configuration contains 1..n properties

Generated Code

Sample

```
TrafficLightCtrl.sct | TrafficLightCtrlStateMachine.java
    break;
    case main_main_trafficlight_interrupted_blinking_Yellow:
        exitSequence_main_main_trafficlight_interrupted_blinking_Yellow();
        break;
    case main_main_trafficlight_normal_normal_Red:
        exitSequence_main_main_trafficlight_normal_normal_Red();
        break;
    case main_main_trafficlight_normal_normal_Yellow:
        exitSequence_main_main_trafficlight_normal_normal_Yellow();
        break;
    case main_main_trafficlight_normal_normal_Green:
        exitSequence_main_main_trafficlight_normal_normal_Green();
        break;
    default:
        break;
}
}

/* Default exit sequence for region blinking */
private void exitSequence_main_main_trafficlight_interrupted_blinking() {
    switch (stateVector[0]) {
        case main_main_trafficlight_interrupted_blinking_Black:
            exitSequence_main_main_trafficlight_interrupted_blinking_Black();
            break;
        case main_main_trafficlight_interrupted_blinking_Yellow:
            exitSequence_main_main_trafficlight_interrupted_blinking_Yellow();
            break;
        default:
            break;
    }
}

/* Default exit sequence for region normal */
private void exitSequence_main_main_trafficlight_normal_normal() {
    switch (stateVector[0]) {
        case main_main_trafficlight_normal_normal_Red:
            exitSequence_main_main_trafficlight_normal_normal_Red();
            break;
        case main_main_trafficlight_normal_normal_Yellow:
            exitSequence_main_main_trafficlight_normal_normal_Yellow();
            break;
        case main_main_trafficlight_normal_normal_Green:
            exitSequence_main_main_trafficlight_normal_normal_Green();
            break;
        default:
            break;
    }
}

/* Default exit sequence for region timer */
private void exitSequence_main_main_timer() {
    switch (stateVector[1]) {
```

Generated Code

Sample

Files

- src-gen
 - traffic.light
 - trafficlightctrl
 - ITrafficLightCtrlStatemachine.java
 - SynchronizedTrafficLightCtrlStatemachine.java
 - TrafficLightCtrlStatemachine.java
 - IStatemachine.java
 - ITimer.java
 - ITimerCallback.java
 - RuntimeService.java
 - TimerService.java

```
TrafficLightCtrl.sct TrafficLightCtrlStatemachine.java
```

```
        break;
    case main_main_trafficlight_interrupted_blinking_Yellow:
        exitSequence_main_main_trafficlight_interrupted_blinking_Yellow();
        break;
    case main_main_trafficlight_normal_normal_Red:
        exitSequence_main_main_trafficlight_normal_normal_Red();
        break;
    case main_main_trafficlight_normal_normal_Yellow:
        exitSequence_main_main_trafficlight_normal_normal_Yellow();
        break;
    case main_main_trafficlight_normal_normal_Green:
        exitSequence_main_main_trafficlight_normal_normal_Green();
        break;
    default:
        break;
    }
}

/* Default exit sequence for region blinking */
private void exitSequence_main_main_trafficlight_interrupted_blinking() {
    switch (stateVector[0]) {
        case main_main_trafficlight_interrupted_blinking_Black:
            exitSequence_main_main_trafficlight_interrupted_blinking_Black();
            break;
        case main_main_trafficlight_interrupted_blinking_Yellow:
            exitSequence_main_main_trafficlight_interrupted_blinking_Yellow();
            break;
        default:
            break;
    }
}

/* Default exit sequence for region normal */
private void exitSequence_main_main_trafficlight_normal_normal() {
    switch (stateVector[0]) {
        case main_main_trafficlight_normal_normal_Red:
            exitSequence_main_main_trafficlight_normal_normal_Red();
            break;
        case main_main_trafficlight_normal_normal_Yellow:
            exitSequence_main_main_trafficlight_normal_normal_Yellow();
            break;
        case main_main_trafficlight_normal_normal_Green:
            exitSequence_main_main_trafficlight_normal_normal_Green();
            break;
        default:
            break;
    }
}

/* Default exit sequence for region timer */
private void exitSequence_main_main_timer() {
    switch (stateVector[1]) {
```

Generated Code

Sample

Files

- src-gen
 - traffic.light
 - trafficlightctrl
 - ITrafficLightCtrlStateMachine.java
 - SynchronizedTrafficLightCtrlStateMachine.java
 - TrafficLightCtrlStateMachine.java
 - IStateMachine.java
 - ITimer.java
 - ITimerCallback.java
 - RuntimeService.java
 - TimerService.java

- 8 files
- 1311 lines of code
- 302 manual (UI) code

```
TrafficLightCtrl.sct TrafficLightCtrlStateMachine.java
```

```
        break;
    case main_main_trafficlight_interrupted_blinking_Yellow:
        exitSequence_main_main_trafficlight_interrupted_blinking_Yellow();
        break;
    case main_main_trafficlight_normal_normal_Red:
        exitSequence_main_main_trafficlight_normal_normal_Red();
        break;
    case main_main_trafficlight_normal_normal_Yellow:
        exitSequence_main_main_trafficlight_normal_normal_Yellow();
        break;
    case main_main_trafficlight_normal_normal_Green:
        exitSequence_main_main_trafficlight_normal_normal_Green();
        break;
    default:
        break;
    }
}

/* Default exit sequence for region blinking */
private void exitSequence_main_main_trafficlight_interrupted_blinking() {
    switch (stateVector[0]) {
        case main_main_trafficlight_interrupted_blinking_Black:
            exitSequence_main_main_trafficlight_interrupted_blinking_Black();
            break;
        case main_main_trafficlight_interrupted_blinking_Yellow:
            exitSequence_main_main_trafficlight_interrupted_blinking_Yellow();
            break;
        default:
            break;
    }
}

/* Default exit sequence for region normal */
private void exitSequence_main_main_trafficlight_normal_normal() {
    switch (stateVector[0]) {
        case main_main_trafficlight_normal_normal_Red:
            exitSequence_main_main_trafficlight_normal_normal_Red();
            break;
        case main_main_trafficlight_normal_normal_Yellow:
            exitSequence_main_main_trafficlight_normal_normal_Yellow();
            break;
        case main_main_trafficlight_normal_normal_Green:
            exitSequence_main_main_trafficlight_normal_normal_Green();
            break;
        default:
            break;
    }
}

/* Default exit sequence for region timer */
private void exitSequence_main_main_timer() {
    switch (stateVector[1]) {
```

Interface

TrafficLightCtrl

```
interface:
  in event police_interrupt
  in event toggle
```

```
interface TrafficLight:
  out event displayRed
  out event displayGreen
  out event displayYellow
  out event displayNone
```

```
interface Timer:
  out event updateTimerColour: string
  out event updateTimerValue: integer
```

```
internal:
  event resetTimer
  event disableTimer
  event enableTimer
  var counter: integer
```

Setup Code (Excerpt)

```
protected void setupStateMachine() {
    statemachine = new SynchronizedTrafficLightCtrlStateMachine();
    timer = new MyTimerService(10.0);
    statemachine.setTimer(timer);

    statemachine.getSCITrafficLight().getListeners().add(new ITrafficLightCtrlStateMachine.SCITrafficLightListener() {
        @Override
        public void onDisplayYellowRaised() {
            setLights(false, true, false);
        }

        public void onDisplayRedRaised() {}

        public void onDisplayNoneRaised() {}

        public void onDisplayGreenRaised() {}
    });

    statemachine.getSCITimer().getListeners().add(new ITrafficLightCtrlStateMachine.SCITimerListener() {
        @Override
        public void onUpdateTimerValueRaised(long value) {
            crossing.getCounterVis().setCounterValue(value);
            repaint();
        }

        @Override
        public void onUpdateTimerColourRaised(String value) {
            crossing.getCounterVis().setColor(value == "Red" ? Color.RED : Color.GREEN);
        }
    });

    buttonPanel.getPoliceInterrupt()
        .addActionListener(e -> statemachine.getSCInterface().raisePolice_interrupt());

    buttonPanel.getSwitchOnOff()
        .addActionListener(e -> statemachine.getSCInterface().raiseToggle());

    statemachine.init();
}

private void setLights(boolean red, boolean yellow, boolean green) {
    crossing.getTrafficLightVis().setRed(red);
    crossing.getTrafficLightVis().setYellow(yellow);
    crossing.getTrafficLightVis().setGreen(green);
    repaint();
}
```

Interface

```
interface TrafficLightCtrl
in event police_interrupt
in event toggle

interface TrafficLight:
out event displayRed
out event displayGreen
out event displayYellow
out event displayNone

interface Timer:
out event updateTimerColour: string
out event updateTimerValue: integer

internal:
event resetTimer
event disableTimer
event enableTimer
var counter: integer
```

Setup Code (Excerpt)

```
protected void setupStateMachine() {
    statemachine = new SynchronizedTrafficLightCtrlStateMachine();
    timer = new MyTimerService(10.0);
    statemachine.setTimer(timer);

    statemachine.getSCITrafficLight().getListeners().add(new ITrafficLightCtrlStateMachine.SCITrafficLightListener() {
        @Override
        public void onDisplayYellowRaised() {
            setLights(false, true, false);
        }

        public void onDisplayRedRaised() {}

        public void onDisplayNoneRaised() {}

        public void onDisplayGreenRaised() {}
    });

    statemachine.getSCITimer().getListeners().add(new ITrafficLightCtrlStateMachine.SCITimerListener() {
        @Override
        public void onUpdateTimerValueRaised(long value) {
            crossing.getCounterVis().setCounterValue(value);
            repaint();
        }

        @Override
        public void onUpdateTimerColourRaised(String value) {
            crossing.getCounterVis().setColor(value == "Red" ? Color.RED : Color.GREEN);
        }
    });

    buttonPanel.getPoliceInterrupt()
        .addActionListener(e -> statemachine.getSCInterface().raisePolice_interrupt());

    buttonPanel.getSwitchOnOff()
        .addActionListener(e -> statemachine.getSCInterface().raiseToggle());

    statemachine.init();
}

private void setLights(boolean red, boolean yellow, boolean green) {
    crossing.getTrafficLightVis().setRed(red);
    crossing.getTrafficLightVis().setYellow(yellow);
    crossing.getTrafficLightVis().setGreen(green);
    repaint();
}
```

Generator

```
GeneratorModel for yakindu::java {
```

```
statechart TrafficLightCtrl {

    feature Outlet {
        targetProject = "traffic_light_history"
        targetFolder = "src-gen"
    }

    feature Naming {
        basePackage = "traffic.light"
        implementationSuffix = ""
    }

    feature GeneralFeatures {
        RuntimeService = true
        TimerService = true
        InterfaceObserverSupport = true
    }

    feature SynchronizedWrapper {
        namePrefix = "Synchronized"
        nameSuffix = ""
    }
}
```

Interface

```
interface TrafficLightCtrl
interface:
  in event police_interrupt
  in event toggle

interface TrafficLight:
  out event displayRed
  out event displayGreen
  out event displayYellow
  out event displayNone

interface Timer:
  out event updateTimerColour: string
  out event updateTimerValue: integer

internal:
  event resetTimer
  event disableTimer
  event enableTimer
  var counter: integer
```

Setup Code (Excerpt)

```
protected void setupStatemachine() {
  statemachine = new SynchronizedTrafficLightCtrlStatemachine();
  timer = new MyTimerService(10.0);
  statemachine.setTimer(timer);

  statemachine.getSCITrafficLight().getListeners().add(new ITrafficLightCtrlStatemachine.SCITrafficLightListener() {
    @Override
    public void onDisplayYellowRaised() {
      setLights(false, true, false);
    }

    public void onDisplayRedRaised() {}

    public void onDisplayNoneRaised() {}

    public void onDisplayGreenRaised() {}
  });

  statemachine.getSCITimer().getListeners().add(new ITrafficLightCtrlStatemachine.SCITimerListener() {
    @Override
    public void onUpdateTimerValueRaised(long value) {
      crossing.getCounterVis().setCounterValue(value);
      repaint();
    }

    @Override
    public void onUpdateTimerColourRaised(String value) {
      crossing.getCounterVis().setColor(value == "Red" ? Color.RED : Color.GREEN);
    }
  });

  buttonPanel.getPoliceInterrupt()
    .addActionListener(e -> statemachine.getSCInterface().raisePolice_interrupt());

  buttonPanel.getSwitchOnOff()
    .addActionListener(e -> statemachine.getSCInterface().raiseToggle());

  statemachine.init();
}

private void setLights(boolean red, boolean yellow, boolean green) {
  crossing.getTrafficLightVis().setRed(red);
  crossing.getTrafficLightVis().setYellow(yellow);
  crossing.getTrafficLightVis().setGreen(green);
  repaint();
}

protected void run() {
  statemachine.enter();
  RuntimeService.getInstance().registerStatemachine(statemachine, 100);
}
```

Generator

```
GeneratorModel for yakindu::java {
```

```
statechart TrafficLightCtrl {

  feature Outlet {
    targetProject = "traffic_light_history"
    targetFolder = "src-gen"
  }

  feature Naming {
    basePackage = "traffic.light"
    implementationSuffix = ""
  }

  feature GeneralFeatures {
    RuntimeService = true
    TimerService = true
    InterfaceObserverSupport = true
  }

  feature SynchronizedWrapper {
    namePrefix = "Synchronized"
    nameSuffix = ""
  }
}
```

Runner

Deployed Application (Scaled Real-Time)



Deploying onto Hardware

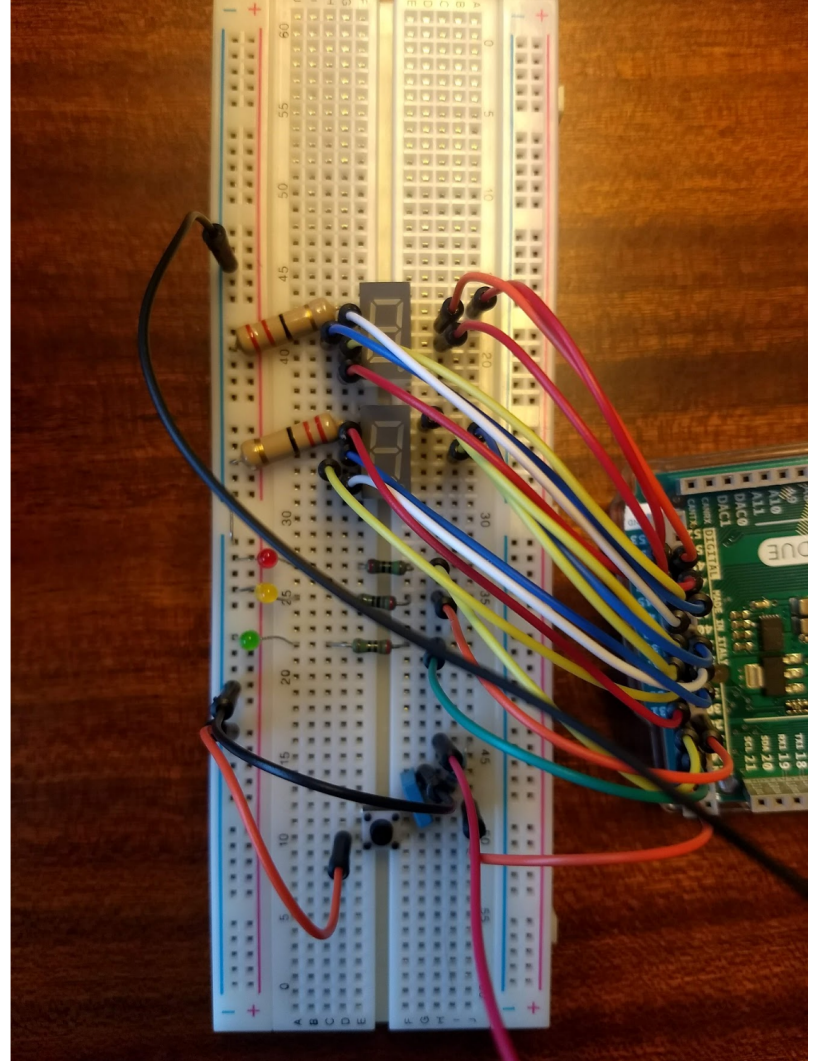

Deploying onto Hardware

Interface:

- `pinMode(pin_nr, mode)`
- `digitalWrite(pin_nr, {0, 1})`
- `digitalRead(pin_nr): {0, 1}`

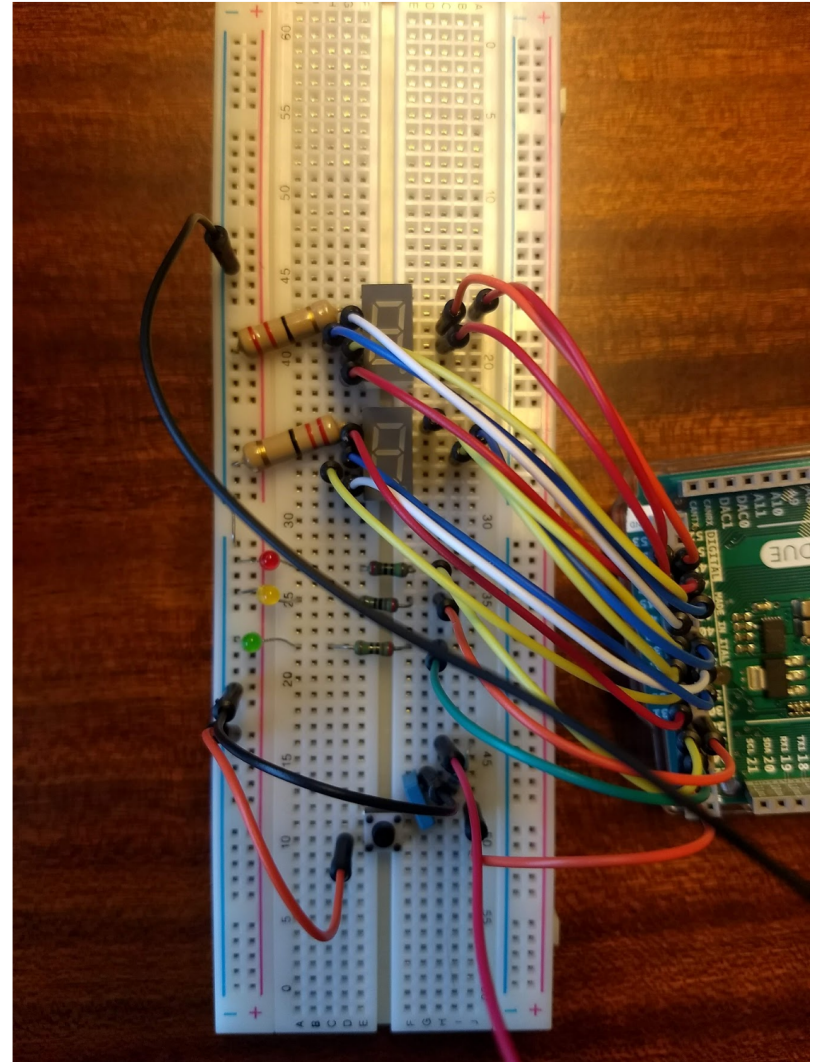
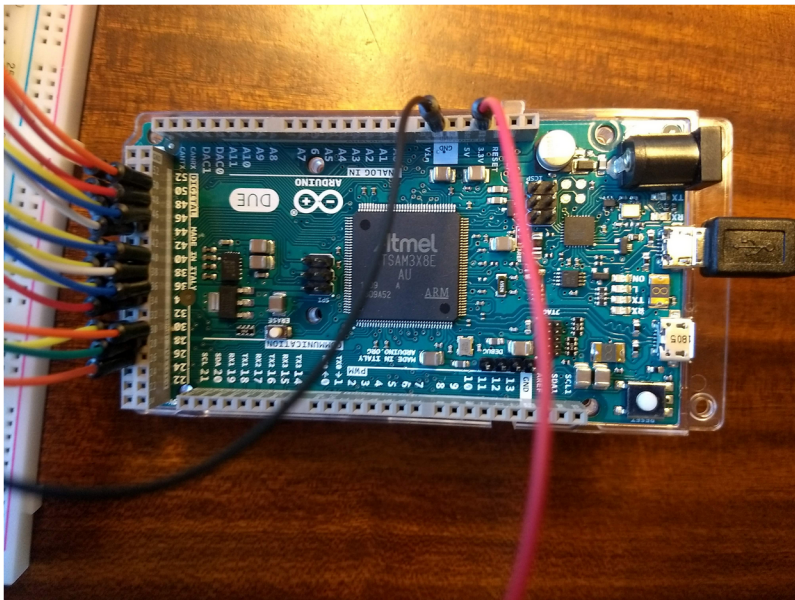

Deploying onto Hardware

Generator

```
GeneratorModel for yakindu::c {  
  
    statechart TrafficLightCtrl {  
  
        feature Outlet {  
            targetProject = "traffic_light_arduino"  
            targetFolder = "src-gen"  
            libraryTargetFolder = "src-gen"  
        }  
  
        feature FunctionInlining {  
            inlineReactions = true  
            inlineEntryActions = true  
            inlineExitActions = true  
            inlineEnterSequences = true  
            inlineExitSequences = true  
            inlineChoices = true  
            inlineEnterRegion = true  
            inlineExitRegion = true  
            inlineEntries = true  
        }  
    }  
}
```

Deploying onto Hardware

Runner

```
#define CYCLE_PERIOD (10)
static unsigned long cycle_count = 0L;
static unsigned long last_cycle_time = 0L;

void loop() {
  unsigned long current_millies = millis();
  read_pushbutton(&pushbutton);
  if ( cycle_count == 0L || (current_millies >= last_cycle_time + CYCLE_PERIOD) ) {
    sc_timer_service_proceed(&timer_service, current_millies - last_cycle_time);
    synchronize(&trafficLight);
    trafficLightCtrl_runCycle(&trafficLight);
    last_cycle_time = current_millies;
    cycle_count++;
  }
}
```

Button Code

```
void read_pushbutton(pushbutton_t *button) {
  int pin_value = digitalRead(button->pin);
  if (pin_value != button->debounce_state) {
    button->last_debounce_time = millis();
  }
  if ((millis() - button->last_debounce_time) > button->debounce_delay) {
    if (pin_value != button->state) {
      button->state = pin_value;
      button->callback(button);
    }
  }
  button->debounce_state = pin_value;
}
```

Deployed Application

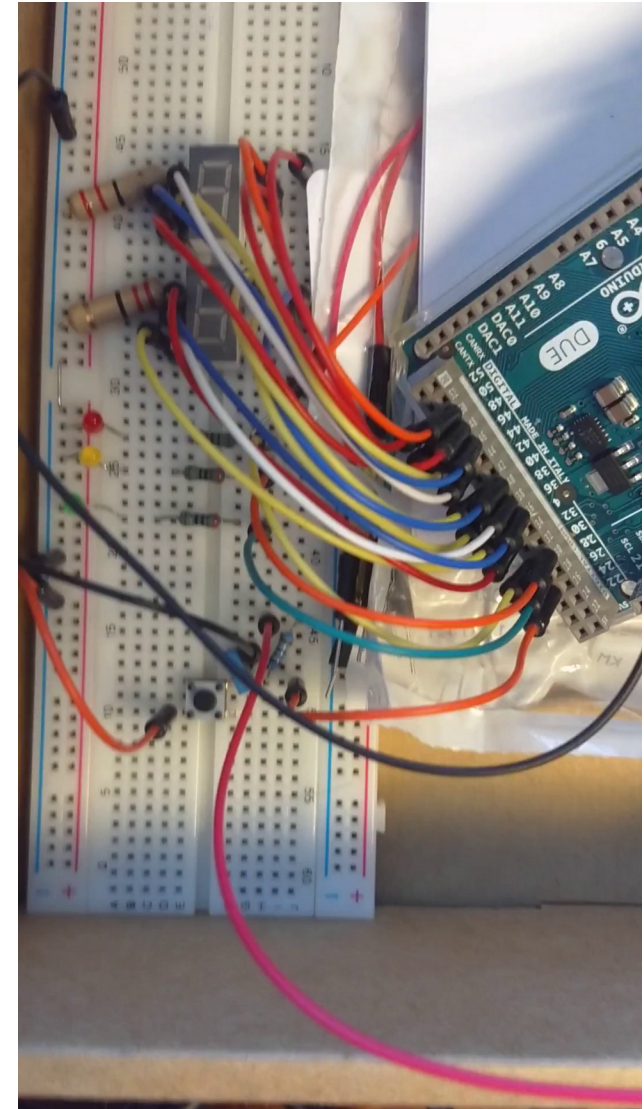

Semantic Choices

Semantic Choices

enabled events: $[inc_one, inc_two]$

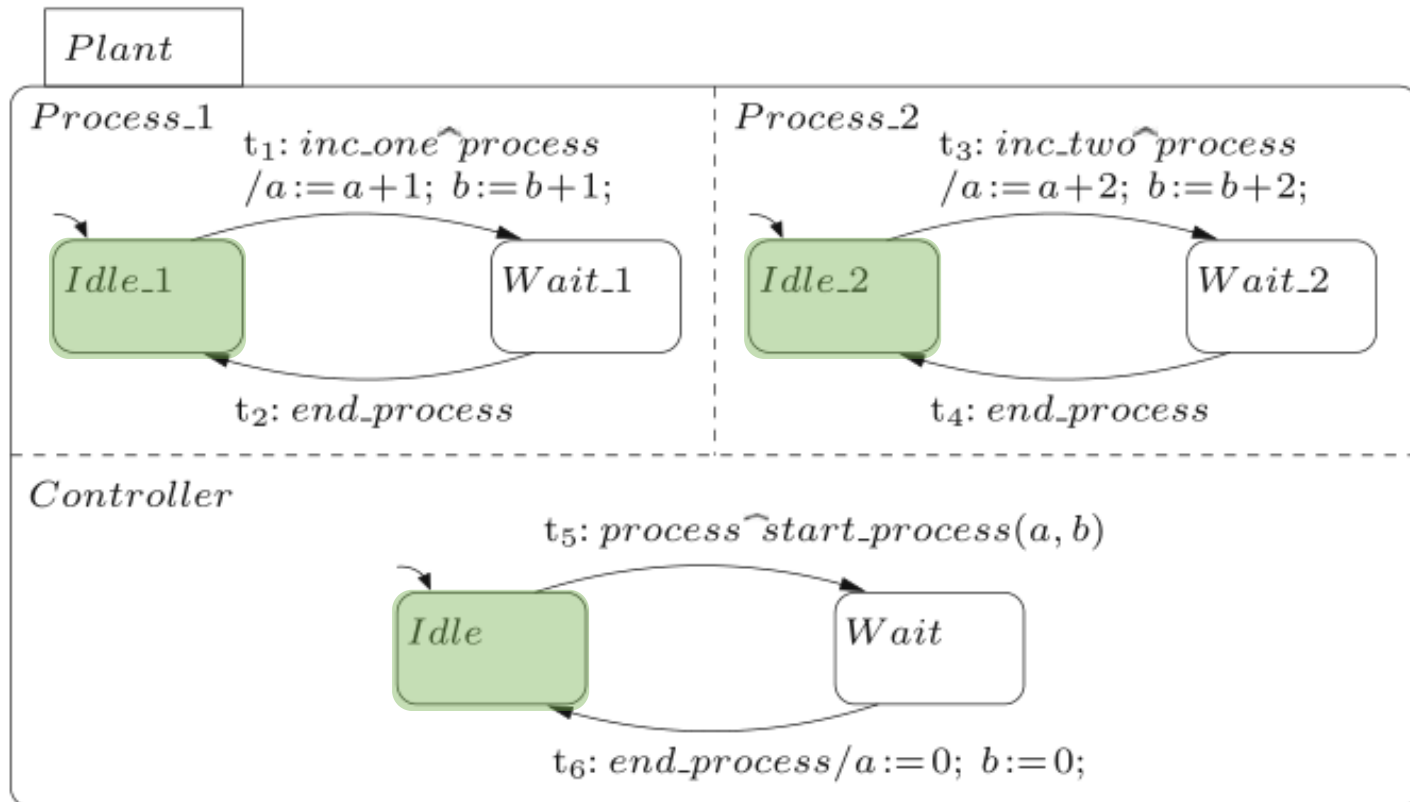

Big Step, Small Step

- A “big step” takes the system from one “quiescent state” to the next.
- A “small step” takes the system from one “snapshot” to the next (execution of a set of enabled transitions).
- A “combo step” groups multiple small steps.

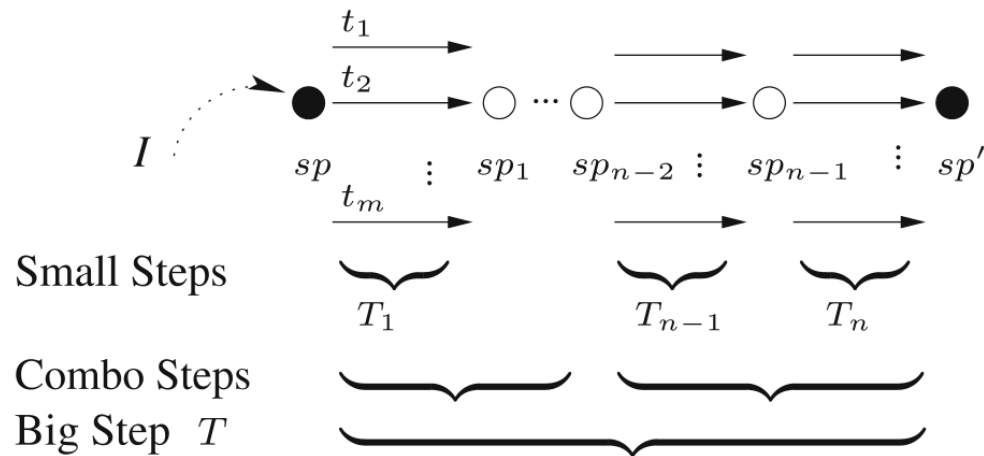

Semantic Options

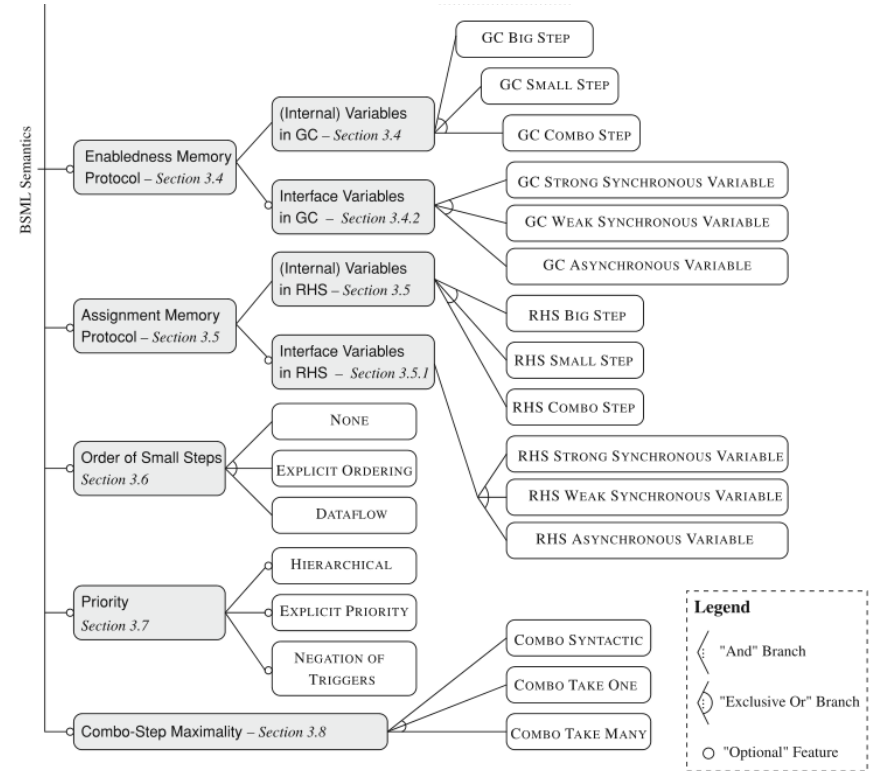
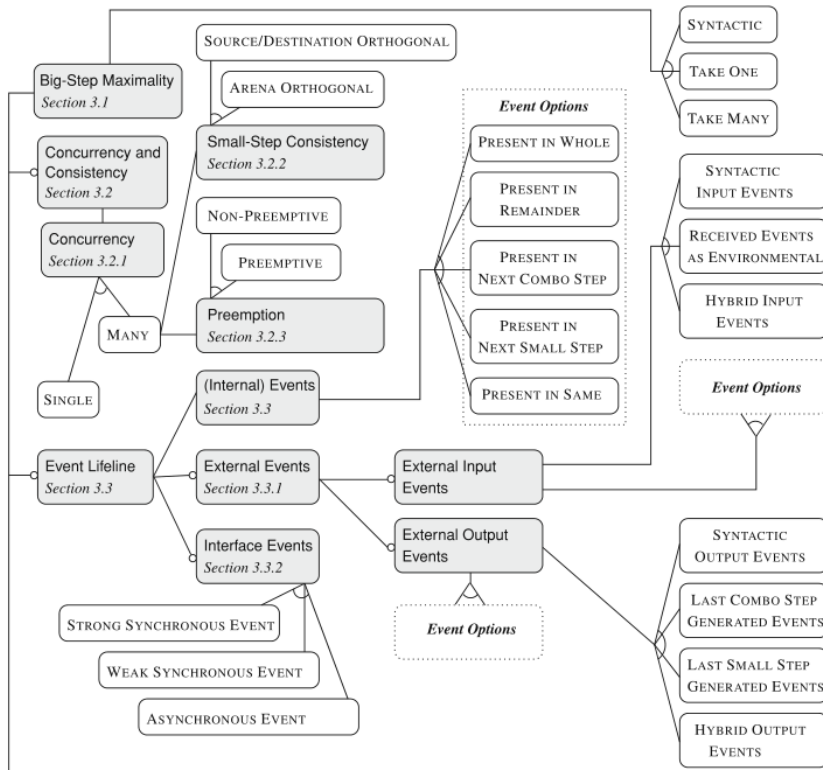

Revisiting the Example

enabled events: $[inc_one, inc_two]$

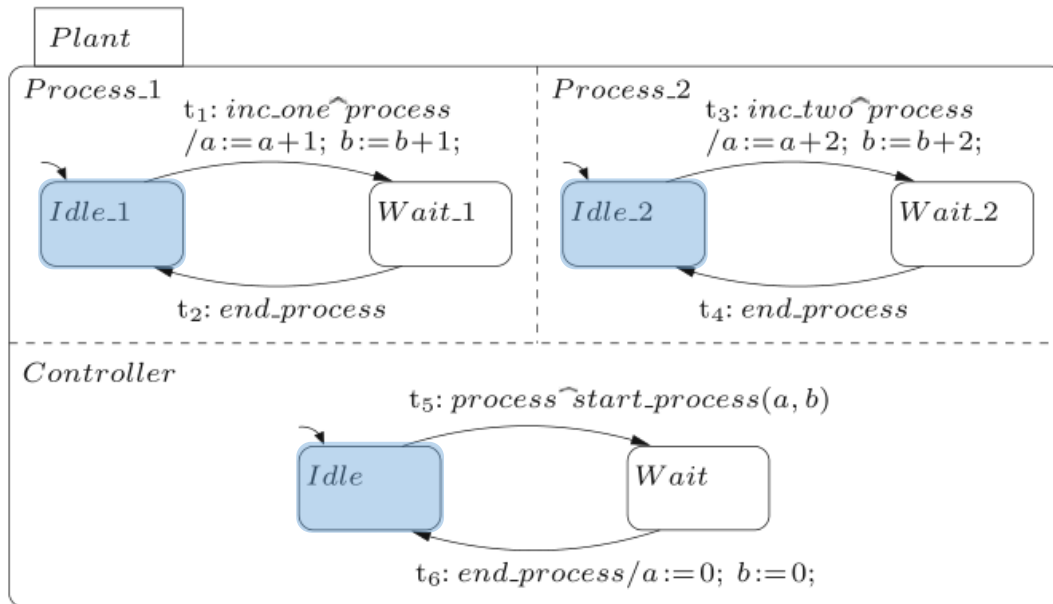

Revisiting the Example

enabled events: $[inc_one, inc_two]$

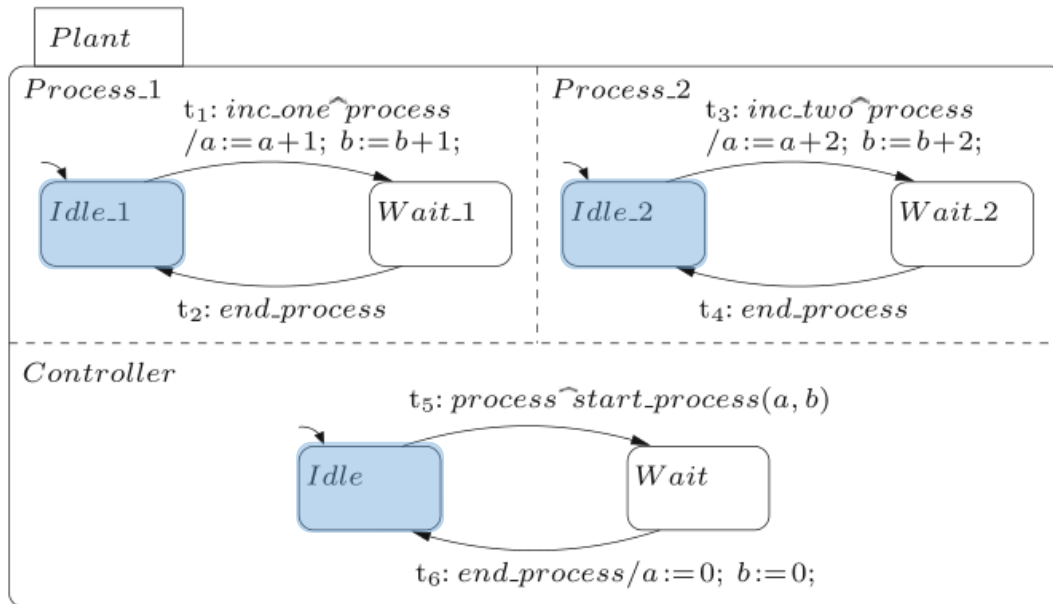

concurrency: single
event lifeline: next combo step
assignment: RHS small step
-> $\langle \{t1\}, \{t3\}, \{t5\} \rangle$ and
 $\langle \{t3\}, \{t1\}, \{t5\} \rangle$

Revisiting the Example

enabled events: $[inc_one, inc_two]$

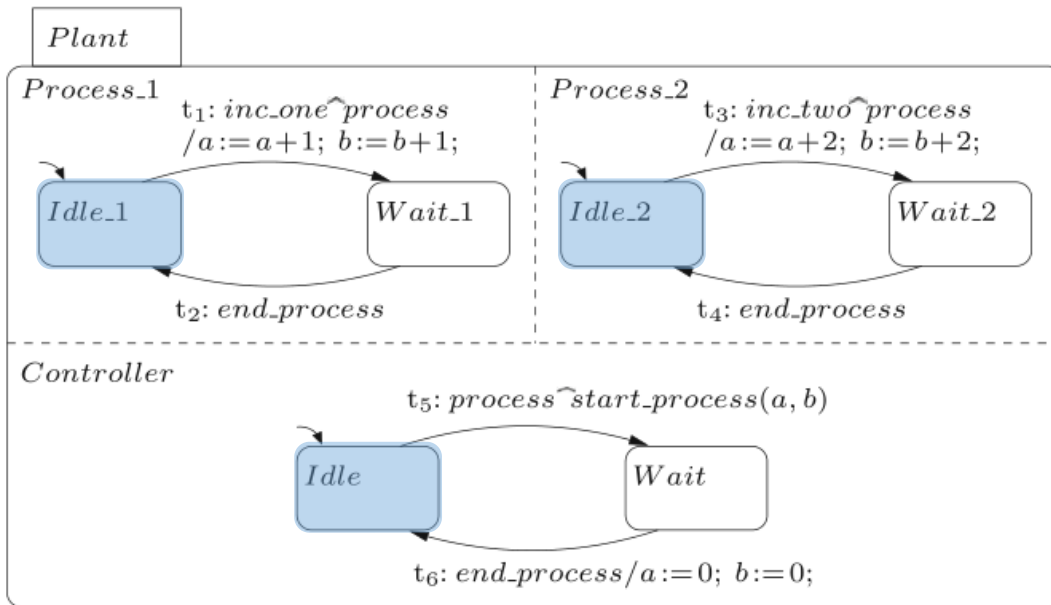

concurrency: single

event lifeline: next combo step

assignment: RHS small step

-> $\langle \{t1\}, \{t3\}, \{t5\} \rangle$ and

$\langle \{t3\}, \{t1\}, \{t5\} \rangle$

event lifeline: present in remainder

-> $\langle \{t1\}, \{t5\}, \{t3\} \rangle$ becomes possible

Event Lifeline

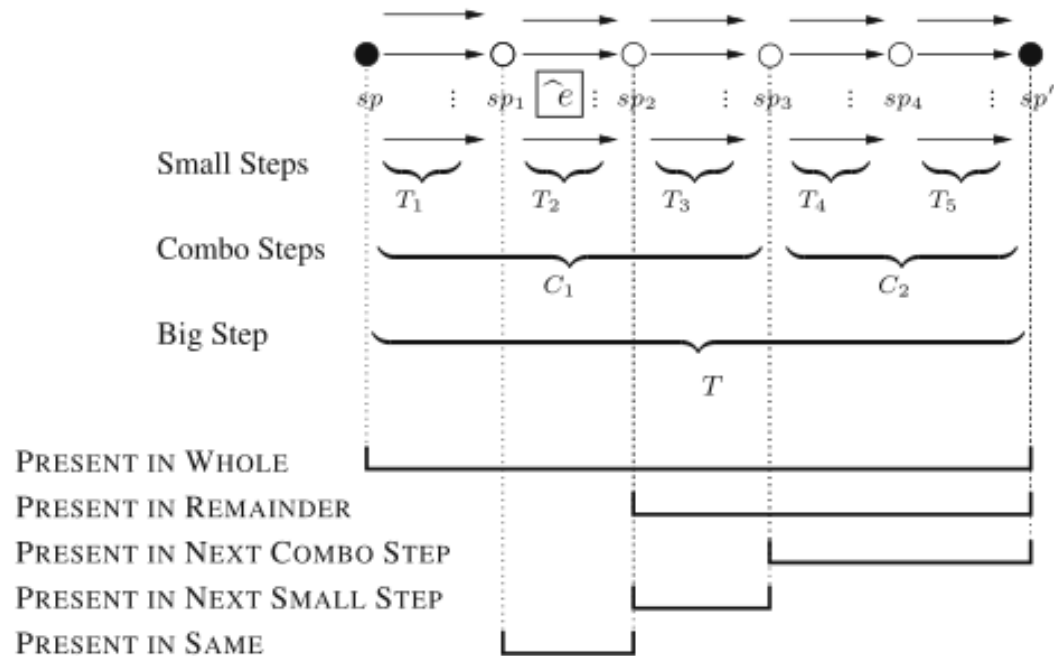

Semantic Options: Examples

	Rhapsody	Statemate	(Default) SCCD
Big Step Maximality	Take Many	Take Many	Take Many
Internal Event Lifeline	Queue	Next Combo Step	Queue
Input Event Lifeline	First Combo Step	First Combo Step	First Combo Step
Priority	Source-Child	Source-Parent	Source-Parent
Concurrency	Single	Single	Single

Composition

Composition of Statecharts

- Composition of multiple Statechart models
 - Instantiation
 - Communication
 - Semantics
- Often solved in code...

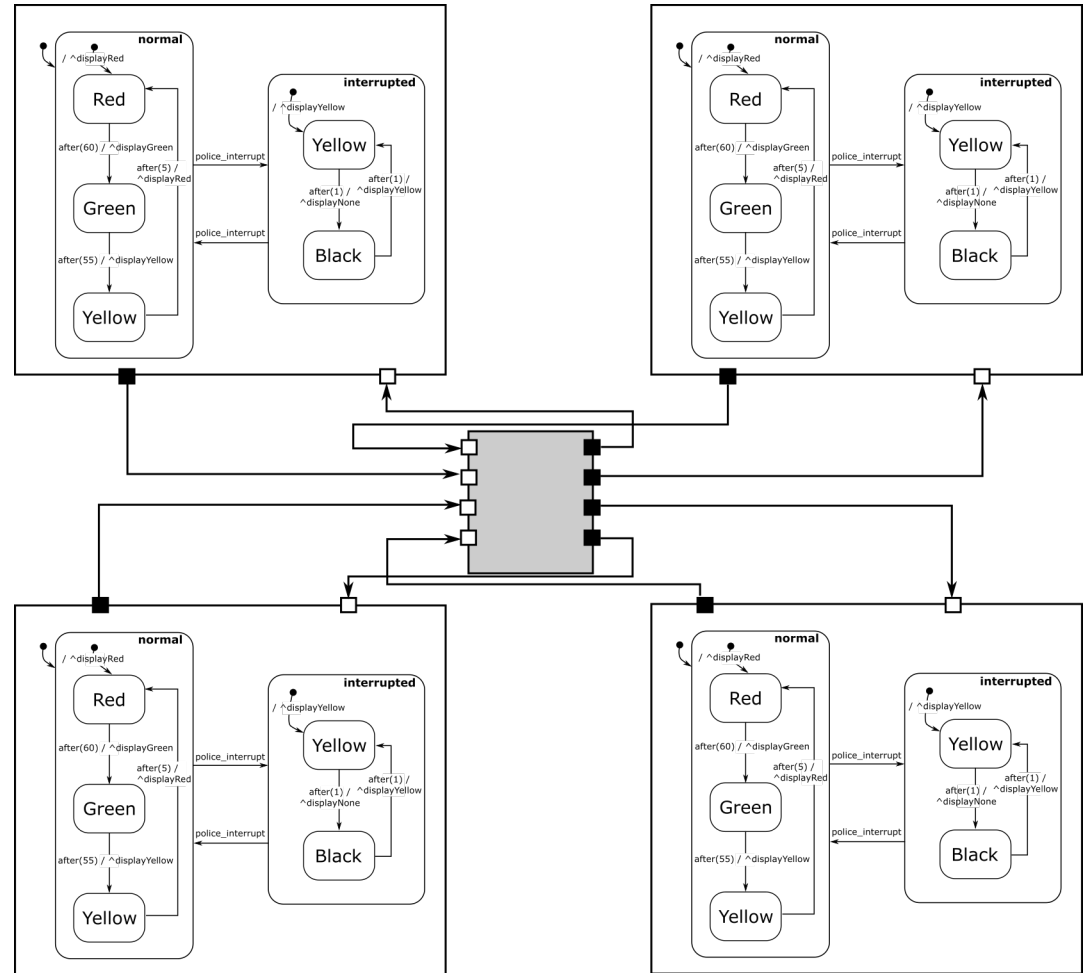

Composition Example

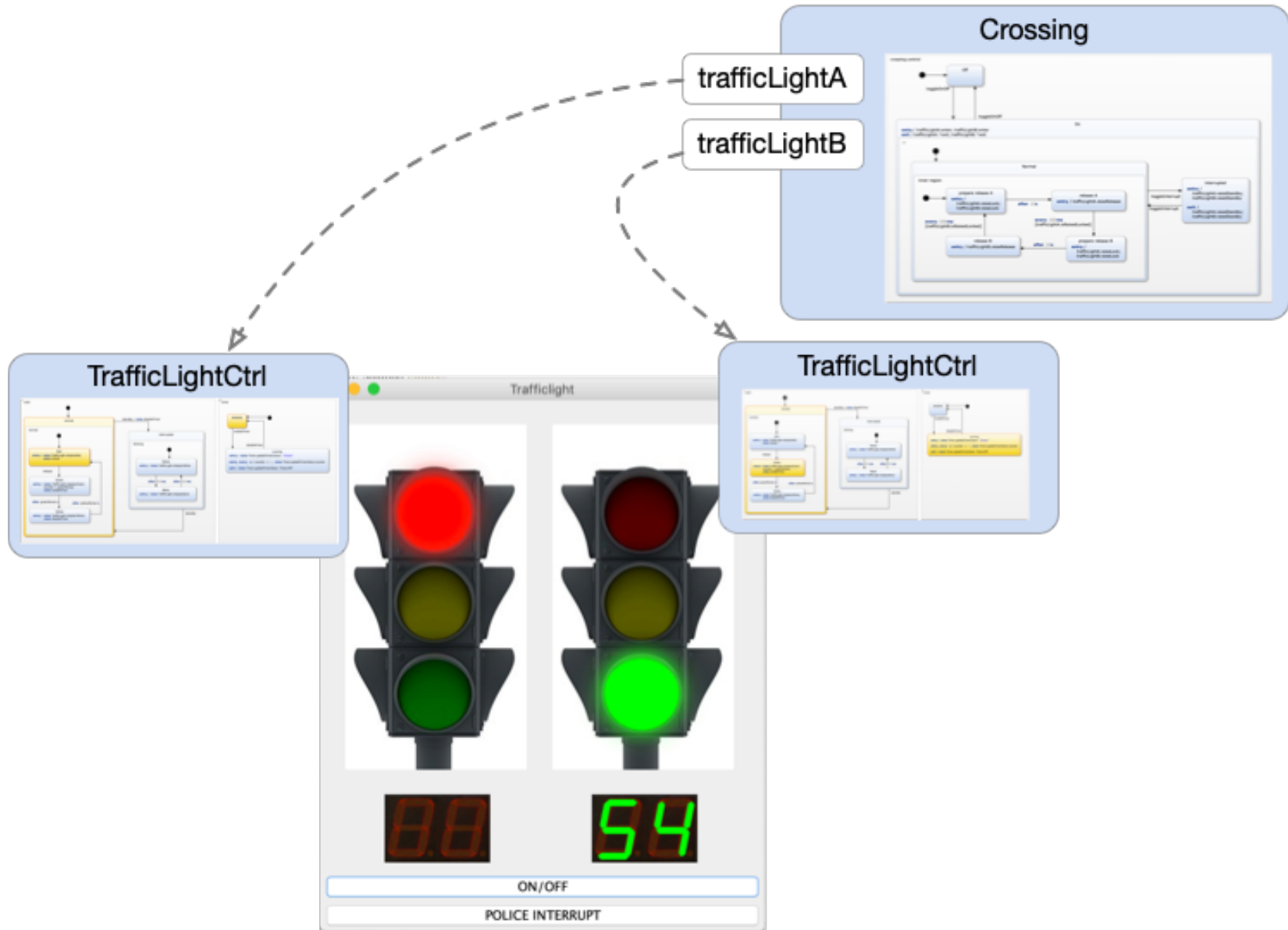

Composition Example

crossing control

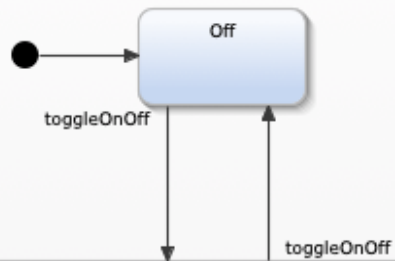

On

entry / trafficLightA.enter; trafficLightB.enter
exit / trafficLightA.^exit; trafficLightB.^exit

r

Normal

inner region

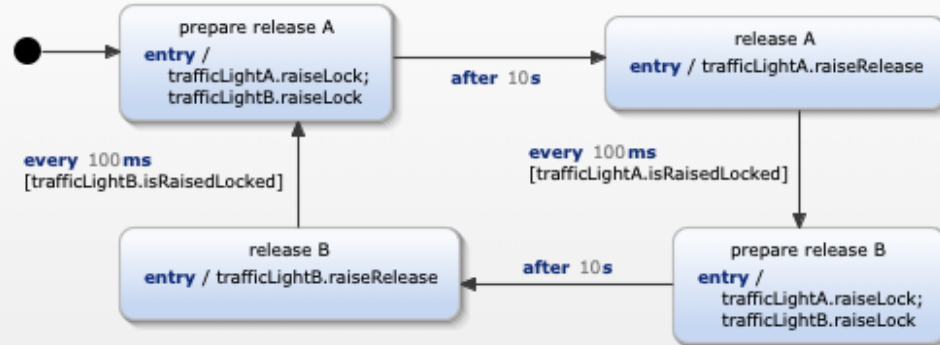

interrupted

entry /
trafficLightA.raiseStandby;
trafficLightB.raiseStandby
exit /
trafficLightA.raiseStandby;
trafficLightB.raiseStandby

toggleInterrupt

toggleInterrupt

Dynamic Structure: SCCD

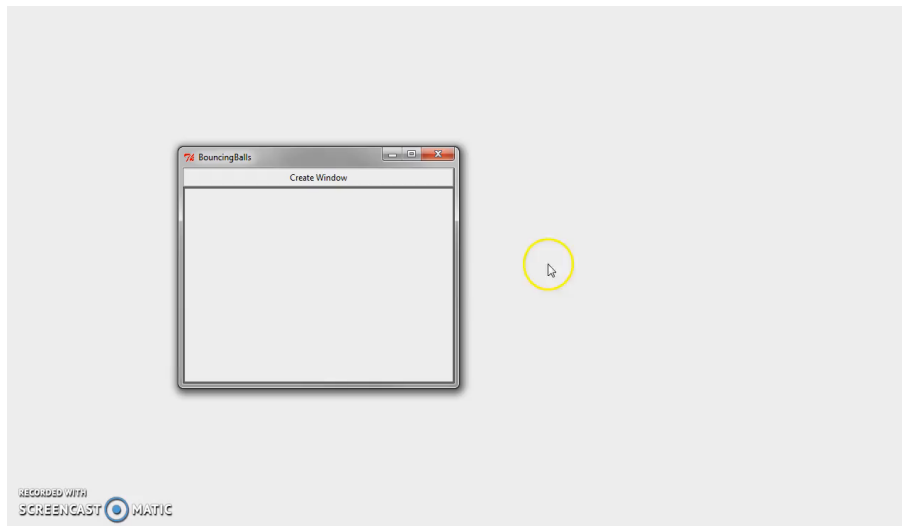

Behavior

- Timed
- Autonomous
- Interactive
- Hierarchical

Structure

- Dynamic
- Hierarchical

Simon Van Mierlo, Yentl Van Tendeloo, Bart Meyers, Joeri Exelmans, and Hans Vangheluwe. SCCD: SCXML extended with class diagrams. In 3rd Workshop on Engineering Interactive Systems with SCXML, part of EICS 2016, 2016.

Dynamic Structure: SCCD

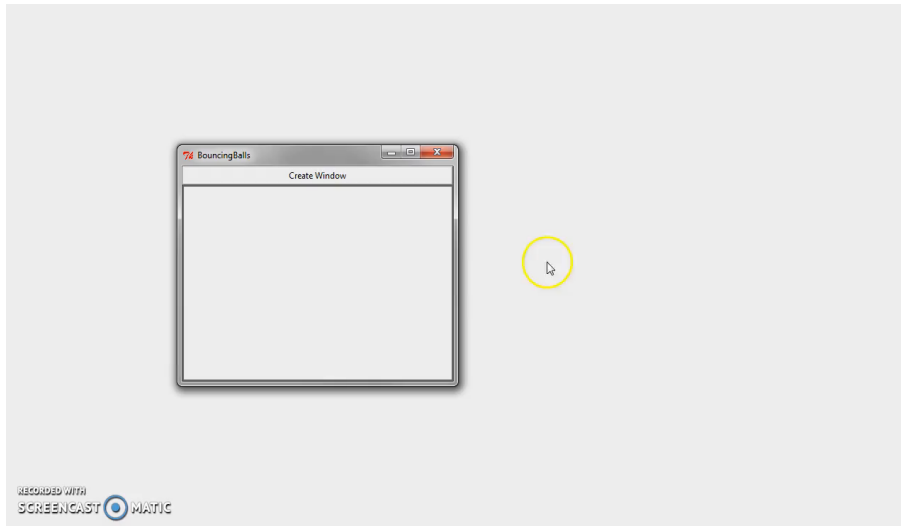

Behavior

- Timed
- Autonomous
- Interactive
- Hierarchical

Structure

- Dynamic
- Hierarchical

Simon Van Mierlo, Yentl Van Tendeloo, Bart Meyers, Joeri Exelmans, and Hans Vangheluwe. SCCD: SCXML extended with class diagrams. In 3rd Workshop on Engineering Interactive Systems with SCXML, part of EICS 2016, 2016.

Dynamic Structure: SCCD

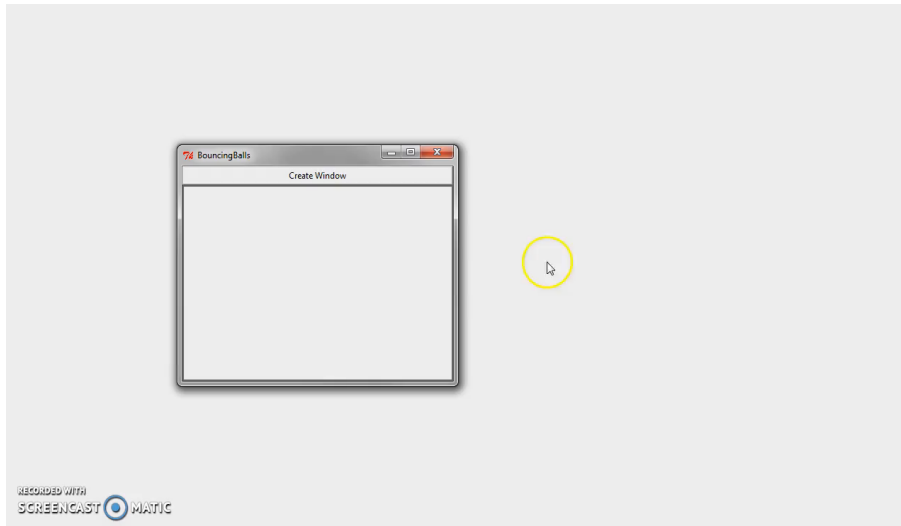

Design?

Behavior

- Timed
- Autonomous
- Interactive
- Hierarchical

Structure

- Dynamic
- Hierarchical

Simon Van Mierlo, Yentl Van Tendeloo, Bart Meyers, Joeri Exelmans, and Hans Vangheluwe. SCCD: SCXML extended with class diagrams. In 3rd Workshop on Engineering Interactive Systems with SCXML, part of EICS 2016, 2016.

Dynamic Structure: SCCD

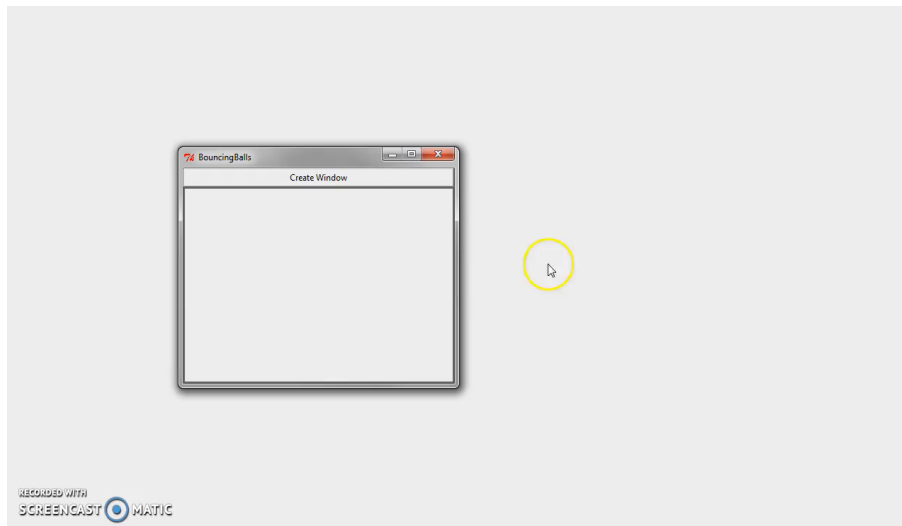

Behavior

- Timed
- Autonomous
- Interactive
- Hierarchical

Structure

- Dynamic
- Hierarchical

Design? [Statecharts](#)

Simon Van Mierlo, Yentl Van Tendeloo, Bart Meyers, Joeri Exelmans, and Hans Vangheluwe. SCCD: SCXML extended with class diagrams. In 3rd Workshop on Engineering Interactive Systems with SCXML, part of EICS 2016, 2016.

Dynamic Structure: SCCD

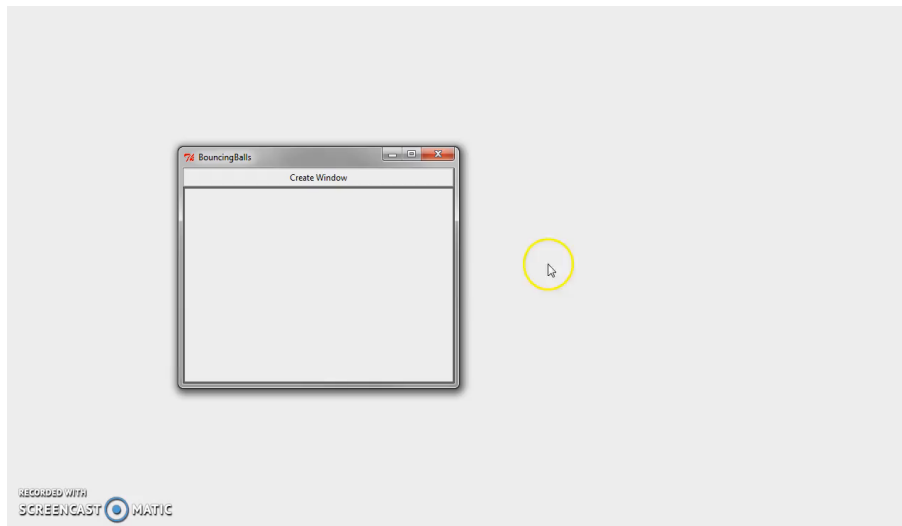

Behavior

- Timed
- Autonomous
- Interactive
- Hierarchical

Structure

- Dynamic
- Hierarchical

Design? Statecharts + ???

Simon Van Mierlo, Yentl Van Tendeloo, Bart Meyers, Joeri Exelmans, and Hans Vangheluwe. SCCD: SCXML extended with class diagrams. In 3rd Workshop on Engineering Interactive Systems with SCXML, part of EICS 2016, 2016.

Dynamic Structure: SCCD

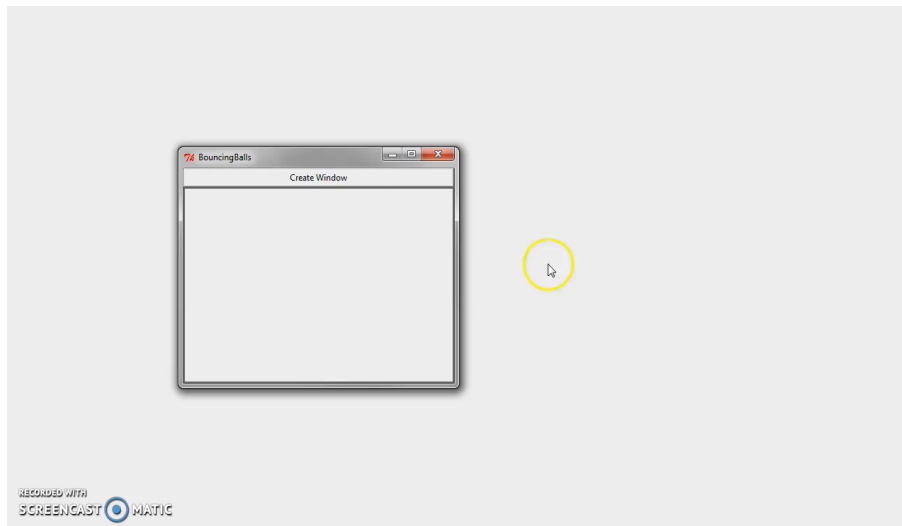

Behavior

- Timed
- Autonomous
- Interactive
- Hierarchical

Structure

- Dynamic
- Hierarchical

Design? **Statecharts** + ??? **Coordination/Communication/Dynamic Structure often implemented in code...**

Simon Van Mierlo, Yentl Van Tendeloo, Bart Meyers, Joeri Exelmans, and Hans Vangheluwe. SCCD: SCXML extended with class diagrams. In 3rd Workshop on Engineering Interactive Systems with SCXML, part of EICS 2016, 2016.

SCCD: Conformance

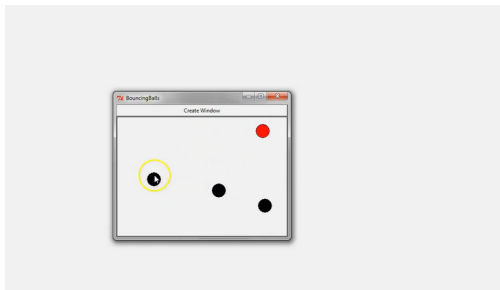
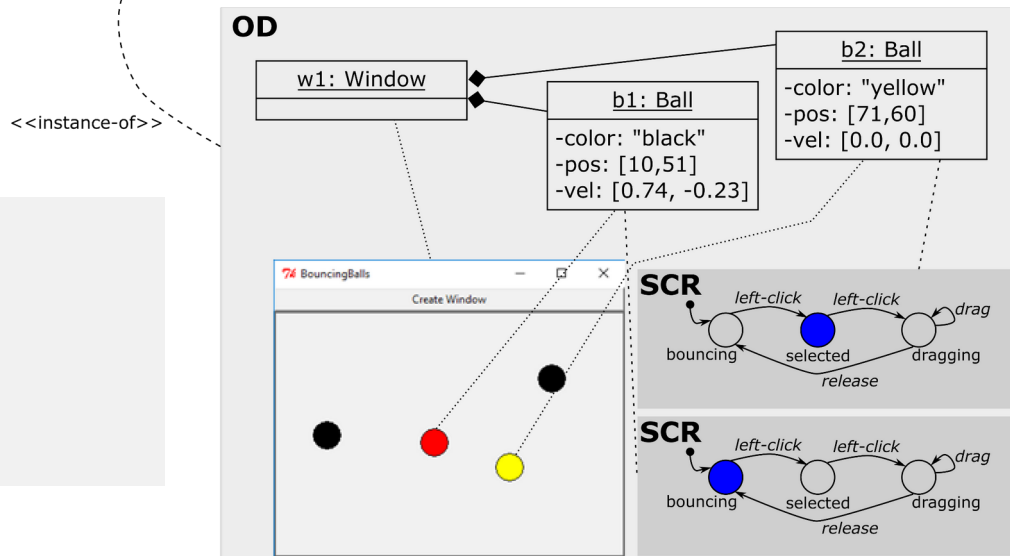
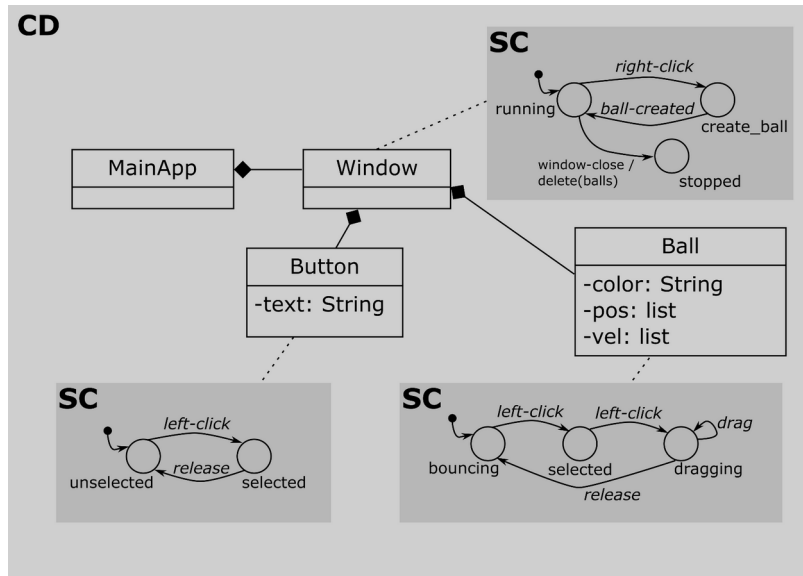

Communication: Event Scopes

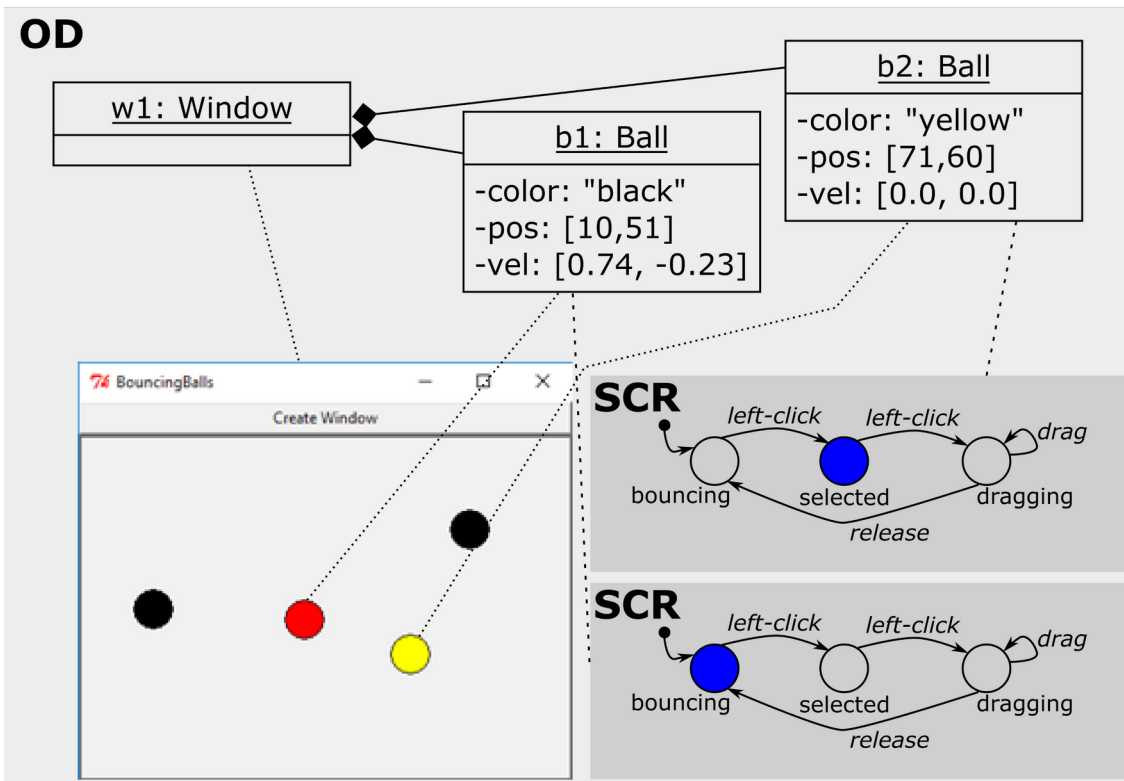

Communication: Event Scopes

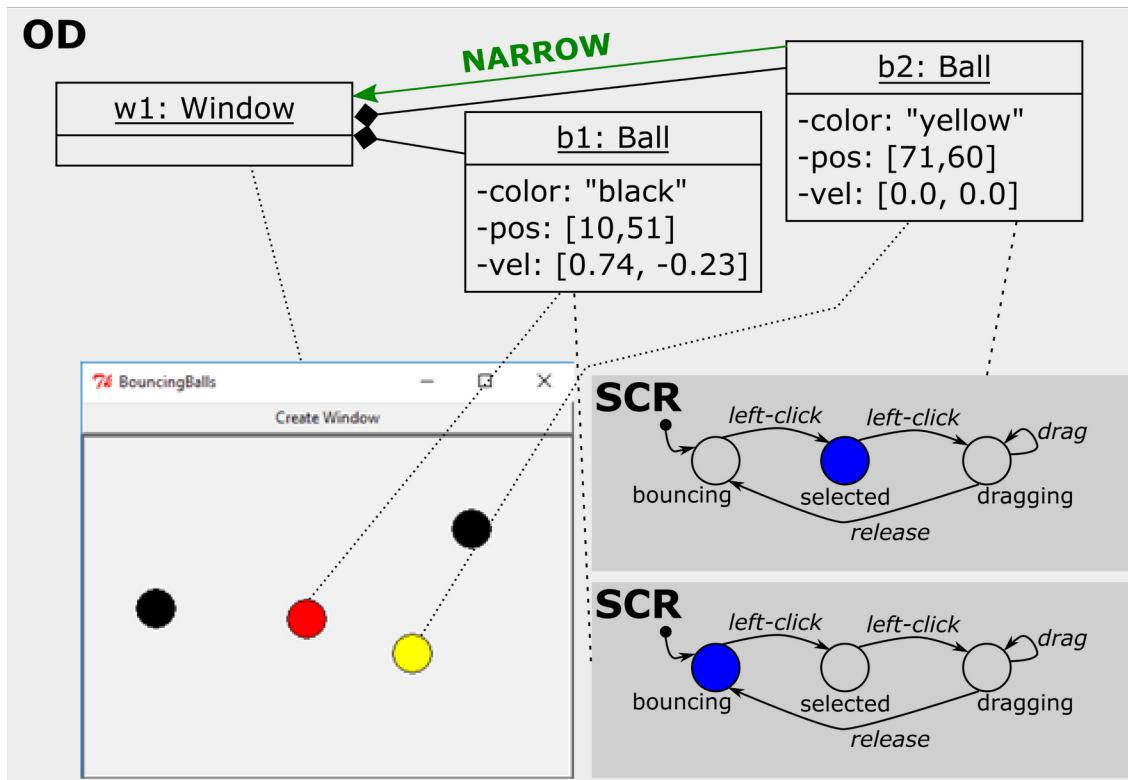

Communication: Event Scopes

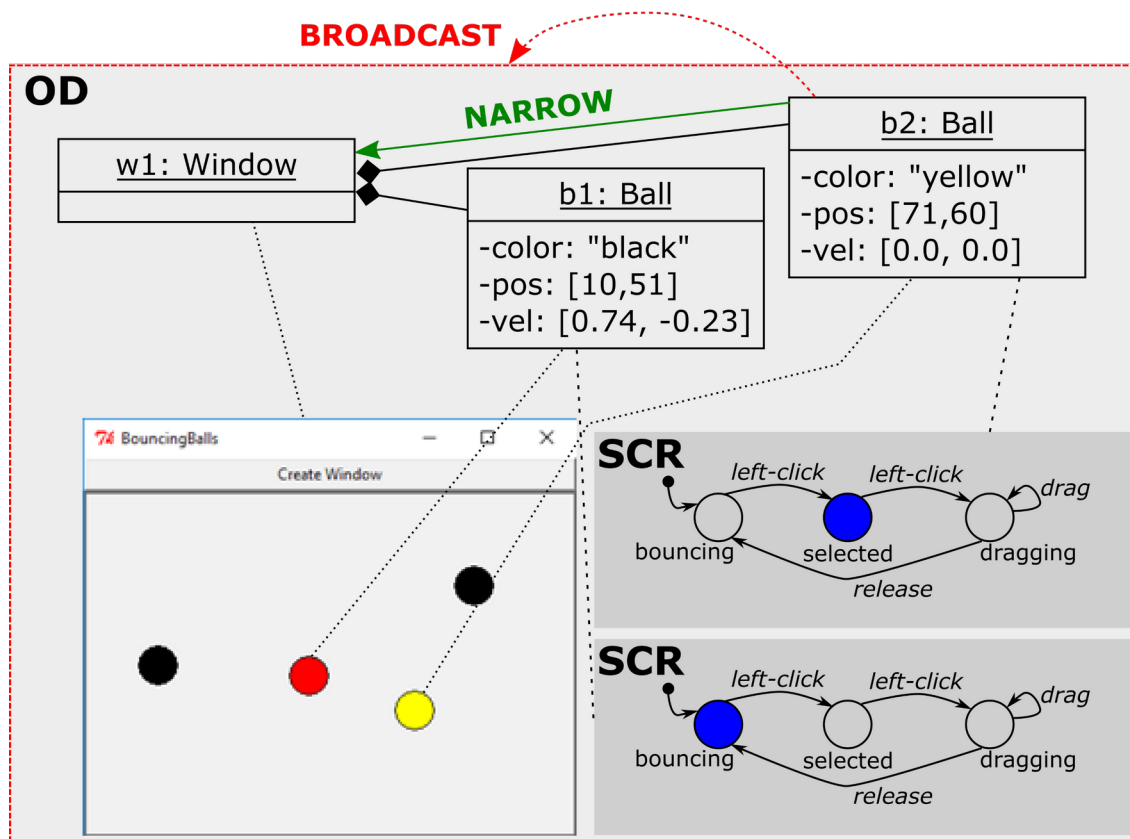

Communication: Event Scopes

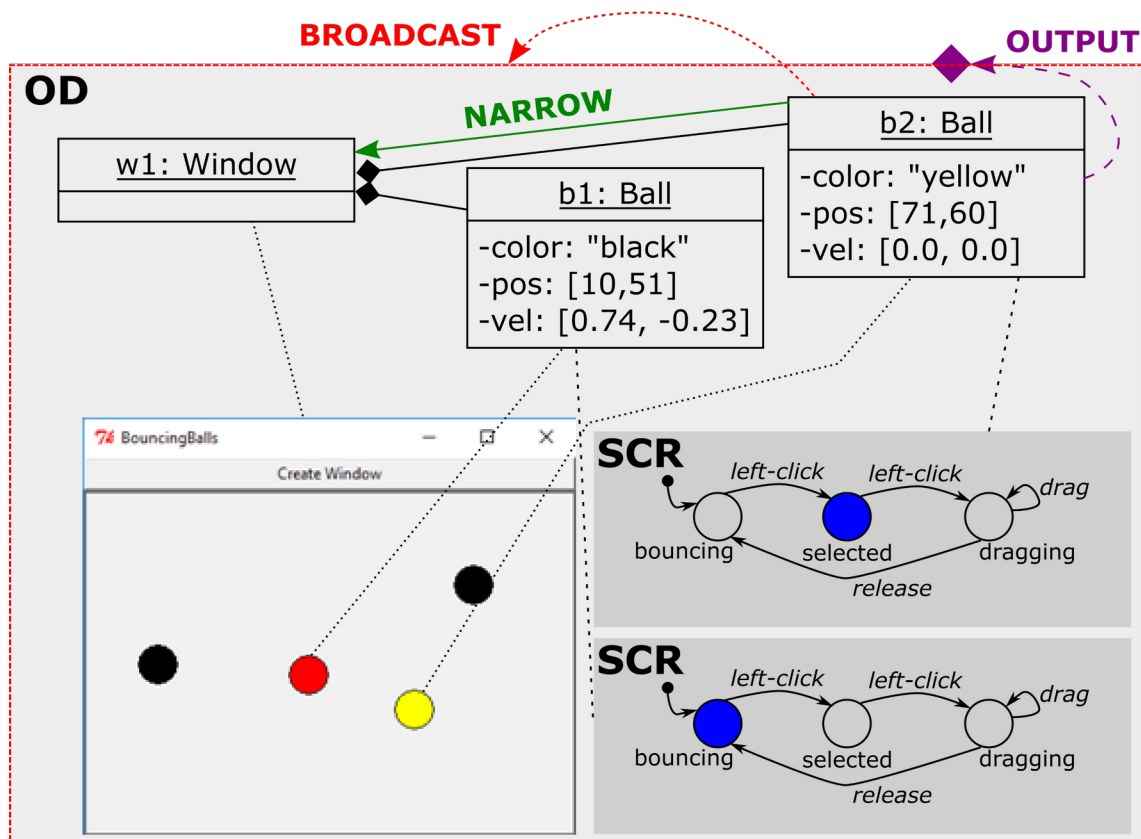

Communication: Event Scopes

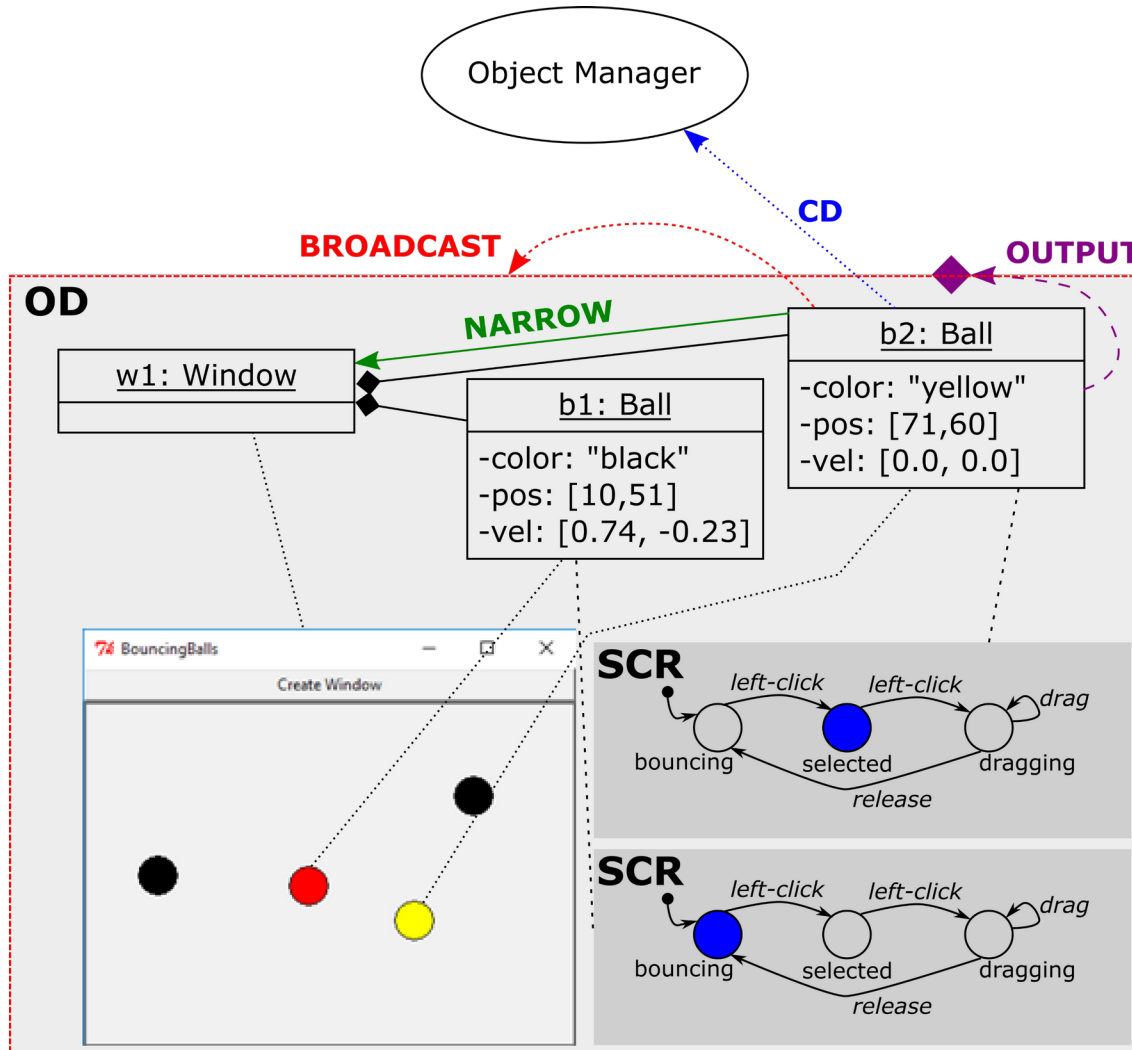

Communication: Event Scopes

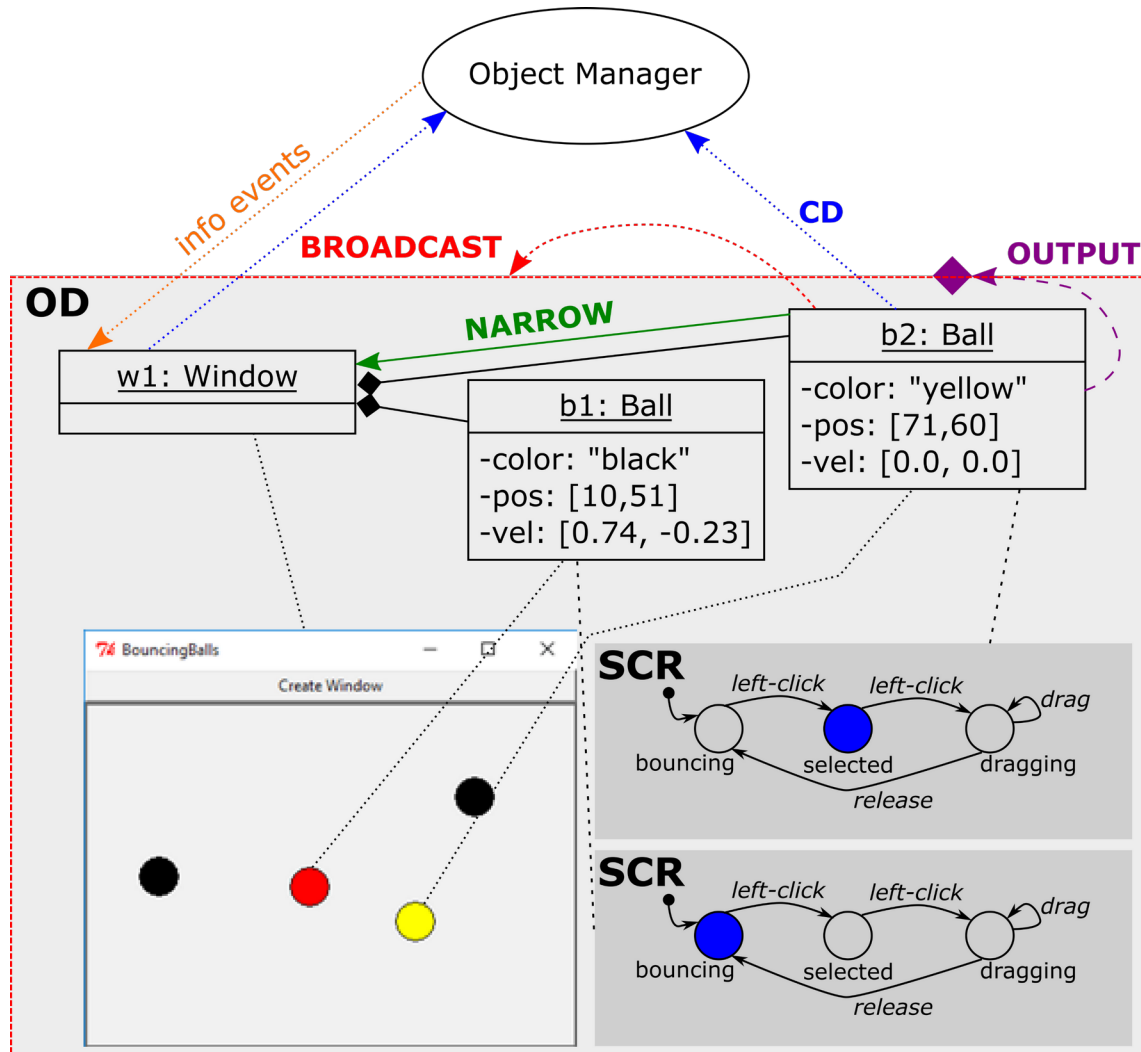

SCCD Compiler

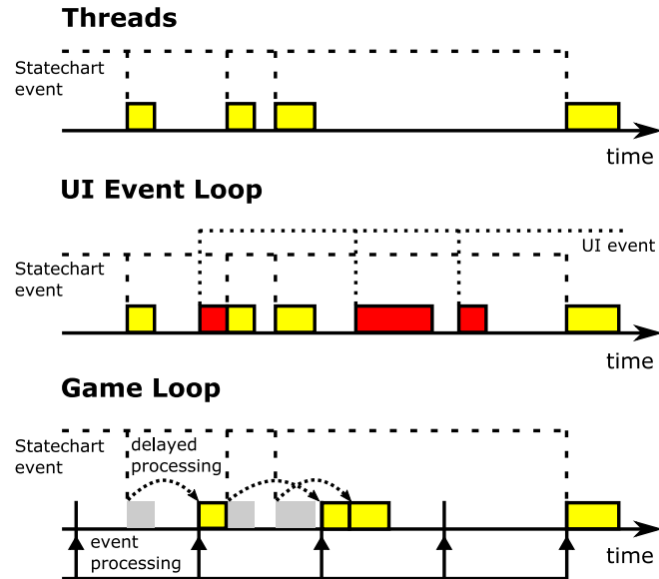
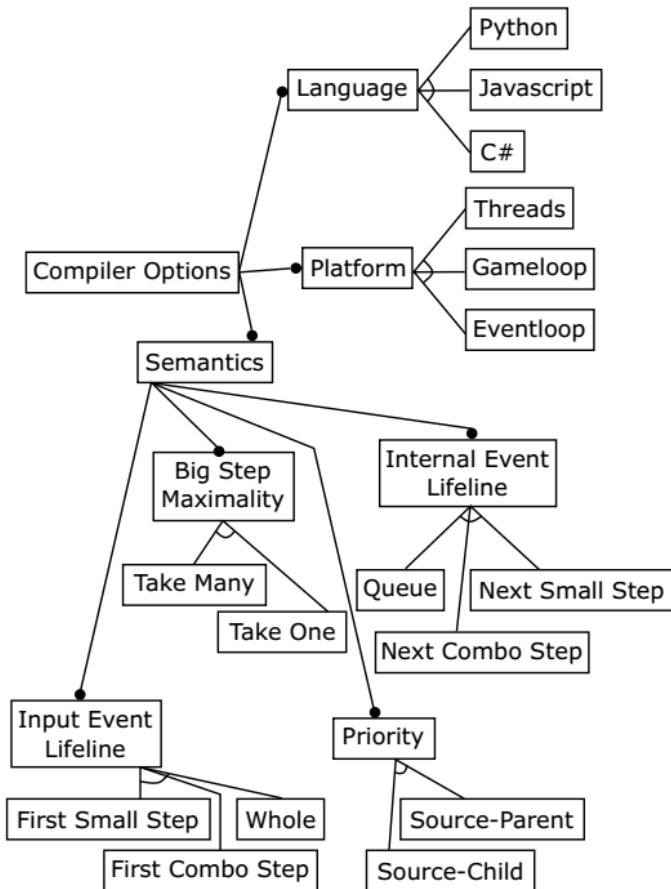

Simon Van Mierlo, Yentl Van Tendeloo, Bart Meyers, Joeri Exelmans, and Hans Vangheluwe. **SCCD: SCXML extended with class diagrams**. In *3rd Workshop on Engineering Interactive Systems with SCXML, part of EICS 2016*, 2016

<https://msdl.uantwerpen.be/documentation/SCCD/>

SCCD Documentation

SCCD [SCCD] is a language that combines the Statecharts [Statecharts] language with Class Diagrams. It allows users to model complex, timed, autonomous, reactive, dynamic-structure systems.

The concrete syntax of SCCD is an XML-format loosely based on the W3C SCXML recommendation. A conforming model can be compiled to a number of programming languages, as well as a number of runtime platforms implemented in those languages. This maximizes the number of applications that can be modelled using SCCD, such as user interfaces, the artificial intelligence of game characters, controller software, and much more.

This documentation serves as an introduction to the SCCD language, its compiler, and the different supported runtime platforms.

Contents

- Installation
 - Download
 - Dependencies
 - SCCD Installation
- Language Features
 - Top-Level Elements
 - Class Diagram Concepts
 - Statechart Concepts
 - Executable Content
 - Macros
 - Object Manager
- Compiler
- Runtime Platforms
 - Threads
 - Eventloop
 - Gameloop
- Examples
 - Timer
 - Traffic Lights
- Semantic Options
 - Big Step Maximality
 - Internal Event Lifeline
 - Input Event Lifeline
 - Priority
 - Concurrency
- Socket Communication
 - Initialization
 - Input Events
 - Output Events
 - HTTP client/server
- Internal Documentation
 - Statecharts Core

References

- [SCCD] Simon Van Mierlo, Yentl Van Tendeloo, Bart Meyers, Joeri Exelmans, and Hans Vangheluwe. SCCD: SCXML extended with class diagrams. In *3rd Workshop on Engineering Interactive Systems with SCXML, part of EICS 2016*, 2016. [LINK]
- [Statecharts] David Harel. Statecharts: A visual formalism for complex systems. *Sci. Comput. Program.* 8, 3 (1987), 231–274. [LINK]

Recap

- Model the behaviour of complex, timed, reactive, autonomous systems
 - “What” instead of “How”
(= implemented by Statecharts compiler)
- Abstractions:
 - States (composite, orthogonal)
 - Transitions
 - Timeouts
 - Events
- Tool support:
 - Yakindu
 - SCCD