

# From Off-Line Validation towards Continual Validation

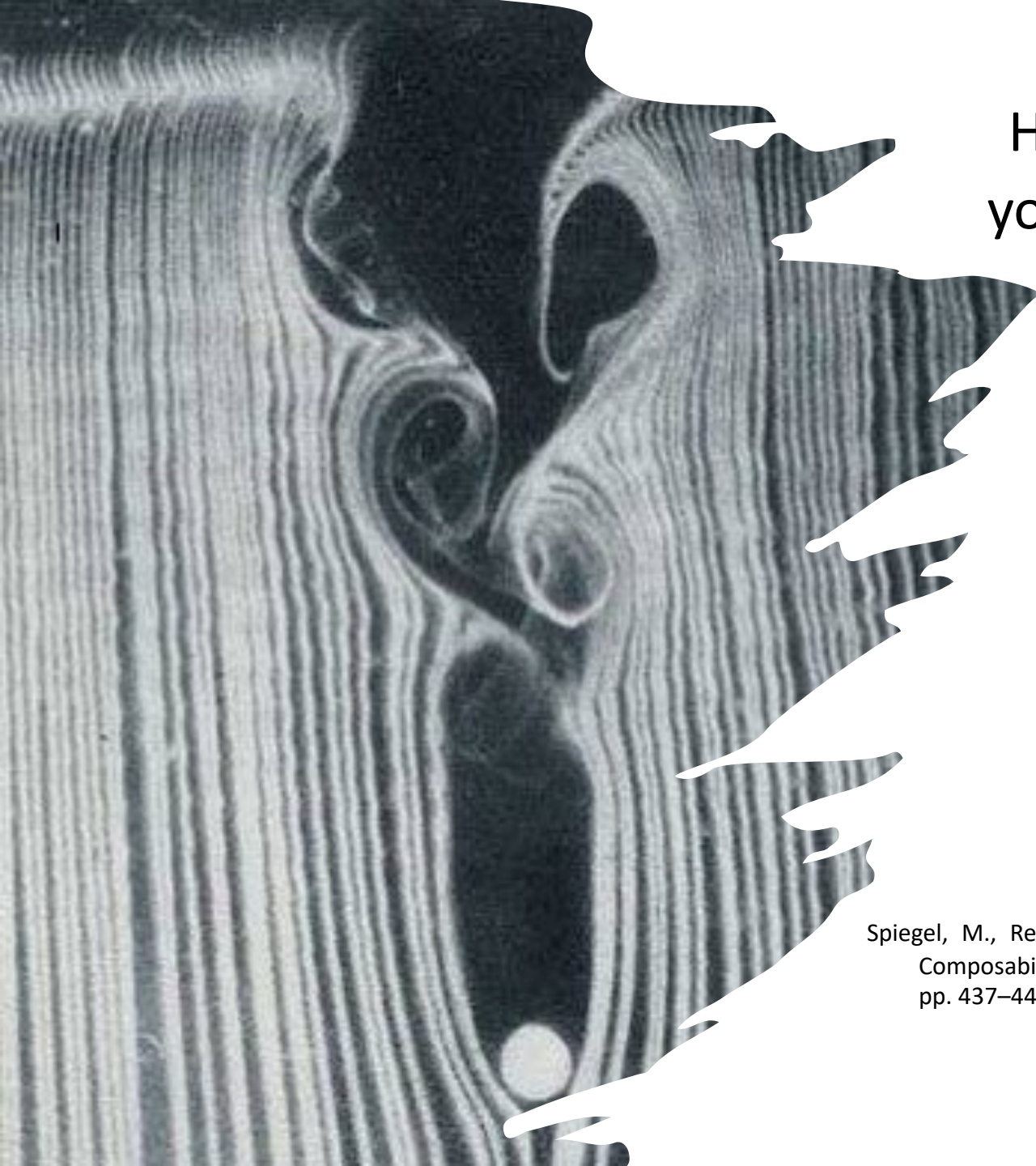

How many contextual constraints can you guess? Under which circumstances can I use this model?

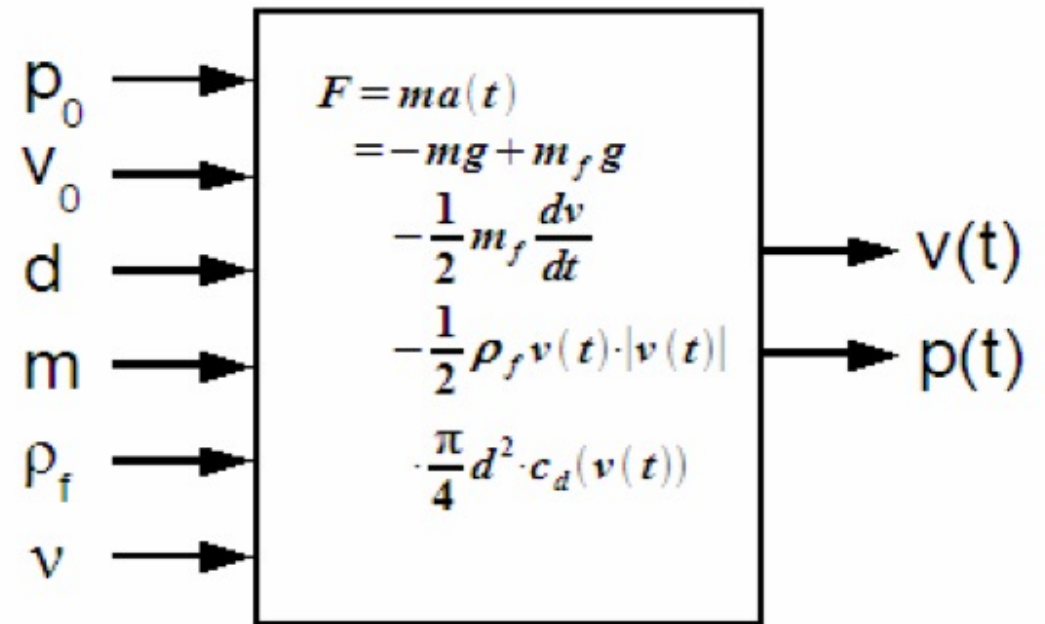

Spiegel, M., Reynolds, P. F., & Brogan, D. C. (2005). A Case Study of Model Context for Simulation Composability and Reusability. In *Proceedings of the Winter Simulation Conference, 2005*. (Vol. 2005, pp. 437–444). IEEE. <http://doi.org/10.1109/WSC.2005.1574279>

## 1. Invariant Constraints

### 1.a Sphere Attributes

1. Sphere Property - The body is a sphere and it remains spherical.
2. Smooth Property - The body is smooth and it remains smooth.
3. Impermeable Property - The body is completely impermeable.
4. Initial Velocity - The body has an initial velocity of  $v_0$  that has no horizontal component of motion.
5. Angular Velocity - The body has no initial angular velocity.
6. Constant Mass - The mass of the body remains constant over time. The body does not experience ablation or accretion.
7. Constant Diameter - The diameter of the body remains constant over time.
8. Distribution of Mass - The body has a centrally symmetric mass distribution that remains constant over time.
9. Uncertainty Principle - The diameter of the body is much greater than the Planck length.
10. Brownian Motion - The mass and diameter of the body are large enough such that Brownian motion of the fluid has negligible impact on the body.
11. General Relativity - The mass of the body is low enough to ignore the gravitational curvature of space-time.

### 1.b Fluid Attributes

12. Fluid Density - The fluid density is constant. The fluid is incompressible.
13. Fluid Pressure - The fluid pressure is constant.
14. Fluid Temperature - The fluid temperature is constant.
15. Kinematic Viscosity - The kinematic viscosity is constant. The medium is a Newtonian fluid.
16. Stationary Fluid - The fluid is stationary apart from being disturbed by the falling body.
17. Infinite Fluid - The volume of the fluid is large enough to completely envelope the sphere. The movement of the fluid is not restricted by a container such as a pipe or tube.

### 1.c Earth Attributes

18. Flat Terrain - The ground does not have terrain and remains flat for all  $t > 0$ .
19. Coriolis Effect - The Earth is not rotating. We ignore the Coriolis effect.

## 2. Dynamic Constraints

20. Mach Speed - The velocity of the body is sufficiently less than the speed of sound for that medium.
21. Special Relativity - The velocity of the body is sufficiently less than the speed of light for that medium.
22. Reynolds Number - The Reynolds number remains between  $10^{-2}$  and  $10^7$  for all  $t > 0$ . The Reynolds number is a function of velocity.

## 3. Inter-Object Constraints

23. Sphere/Fluid Interaction - The body and the fluid interact only through buoyancy and drag. For example, the body cannot dissolve in the fluid, nor can the body transfer heat to the fluid.
24. Sphere/Earth Interaction - The body and the earth interact only through the gravitational force.
25. Fluid/Earth Interaction - The fluid and the earth do not interact.
26. Closed System - The Earth, sphere, and fluid do not interact with any other objects.
27. Simple Gravity - Gravity is a constant downward force of  $9.8 \text{ m/s}^2$ .
28. One-Sided Gravity - The mass of the body is much less than the mass of the Earth. The Earth is not affected by the gravitational pull of the body.
29. Inelastic Collision - The collision between the sphere and the ground is perfectly inelastic.

# M&S Workflow

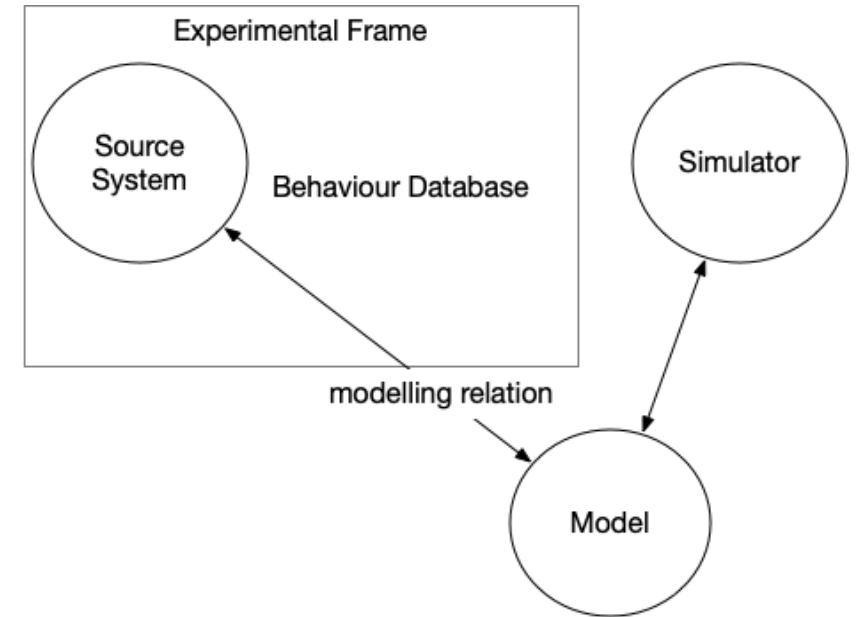
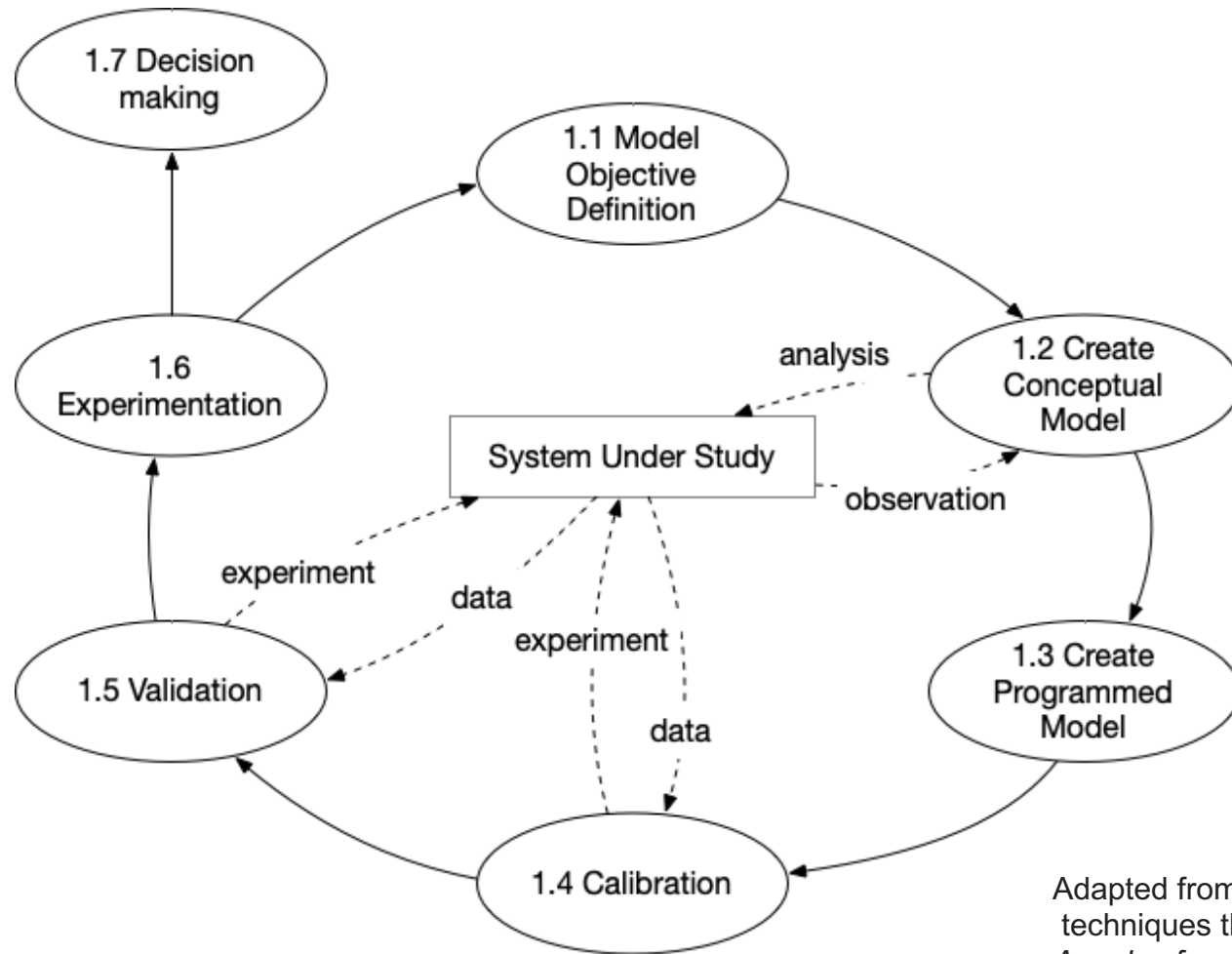

From: Zeigler, Theory of Modelling and Simulation

Adapted from: Balci, Osman. "Validation, verification, and testing techniques throughout the life cycle of a simulation study." *Annals of operations research* 53.1 (1994): 121-173.

# What is Validity?

*“A computerized model within its domain of applicability possesses a satisfactory range of accuracy consistent with the intended application of the model”* Schlesinger et al. 1979 (SCS Working group)

# Substitutability

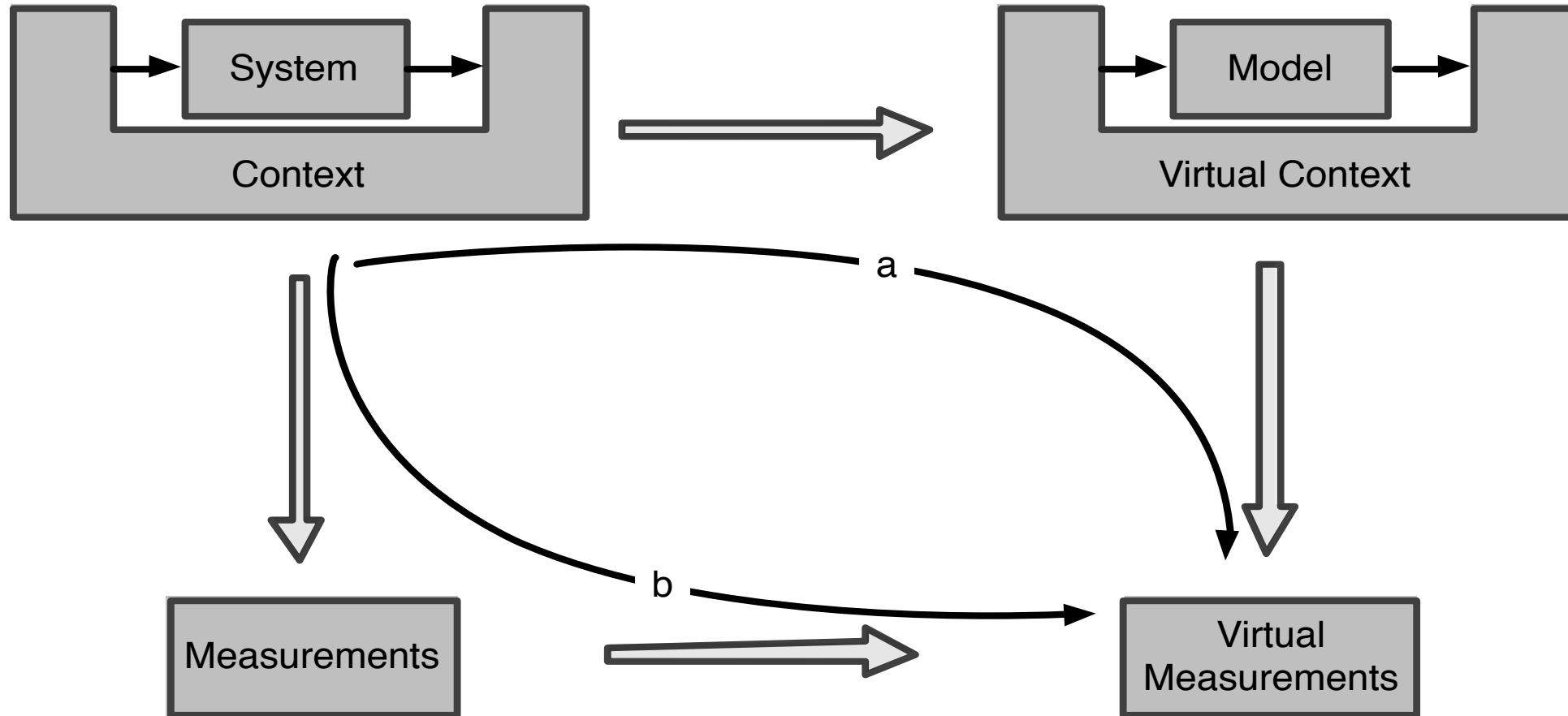

# The same applies for Models of Models

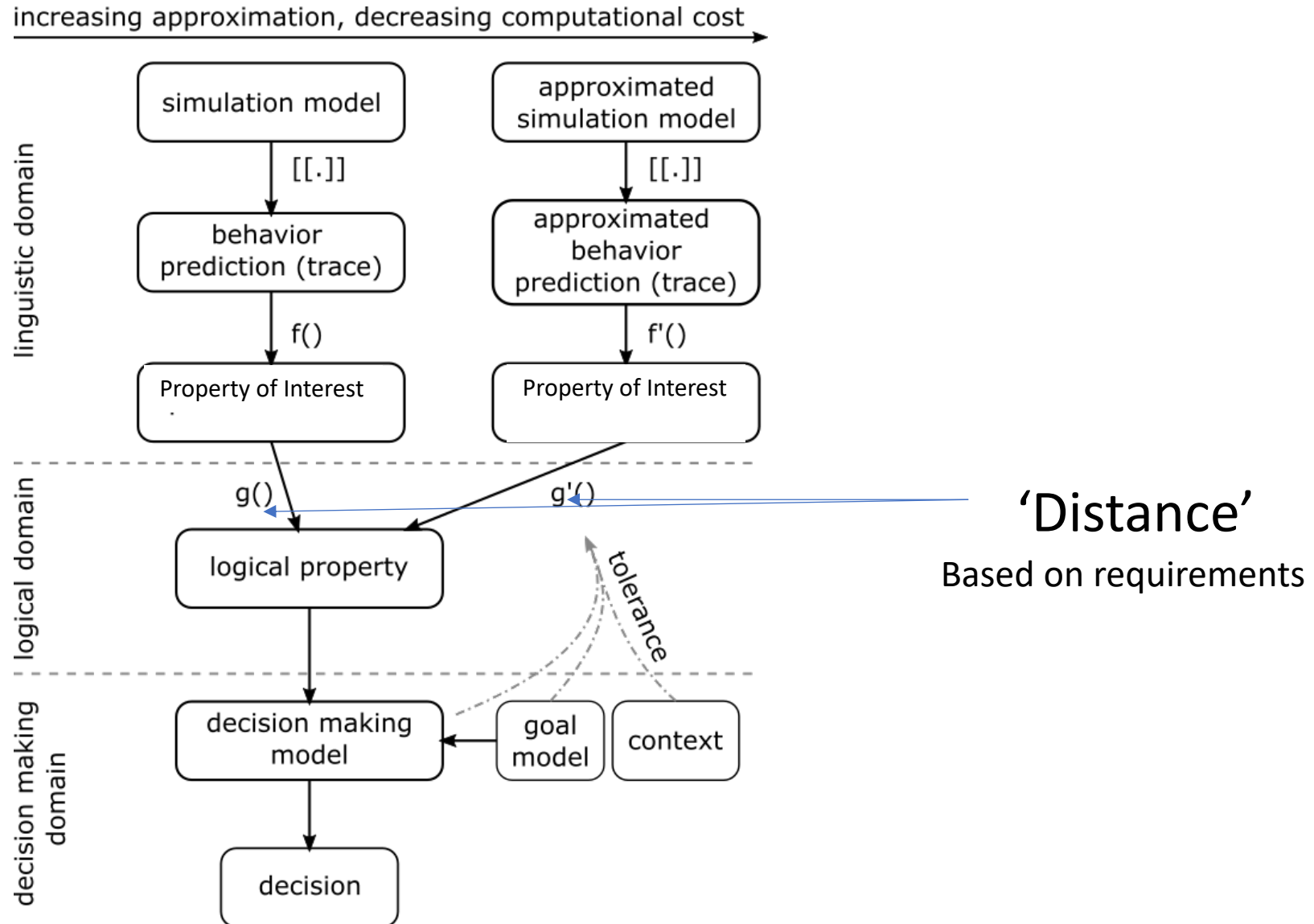



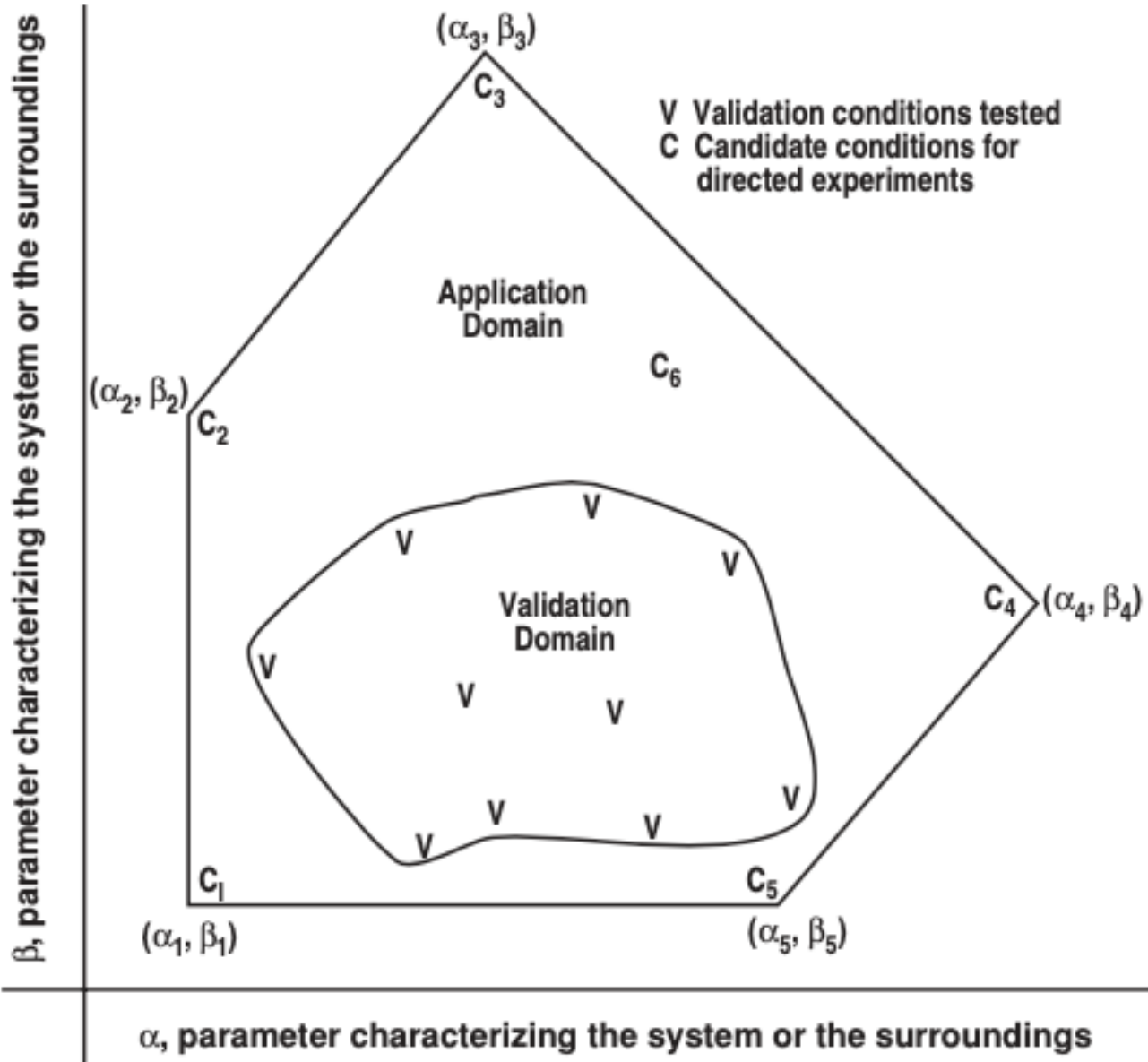

Valid where?

From: Oberkampf and Roy, Verification and Validation in Scientific Computing, Cambridge, 20



# Threats To Validity

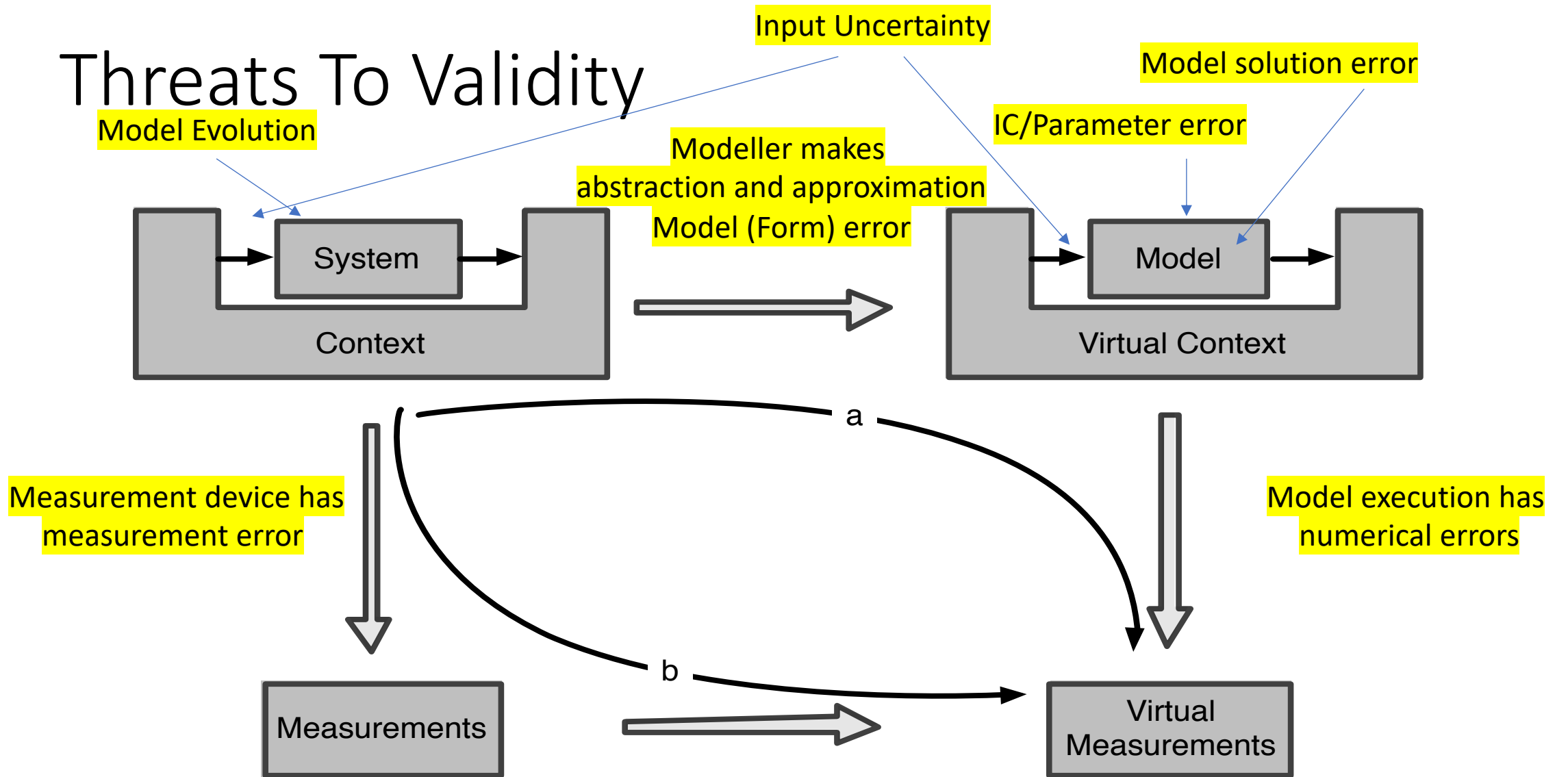

# Small Example: Notch Filter

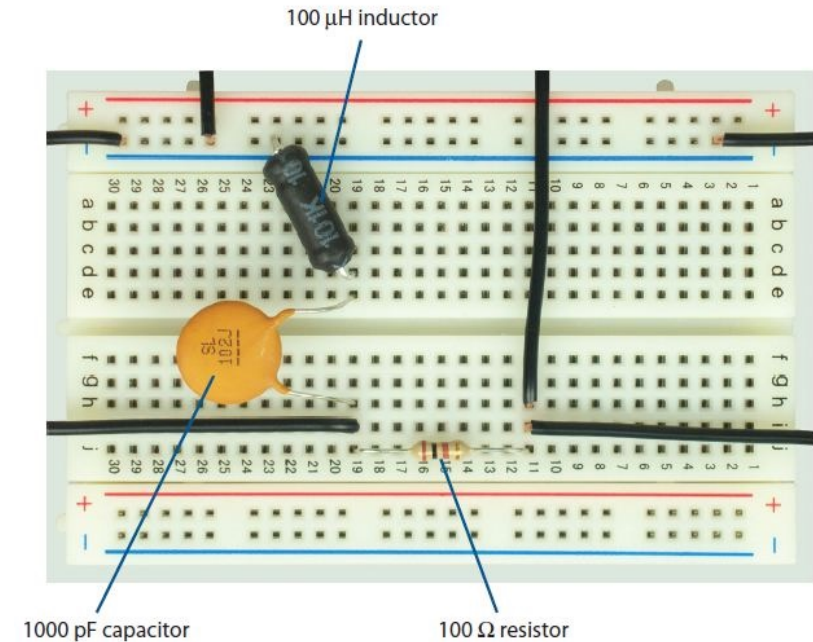
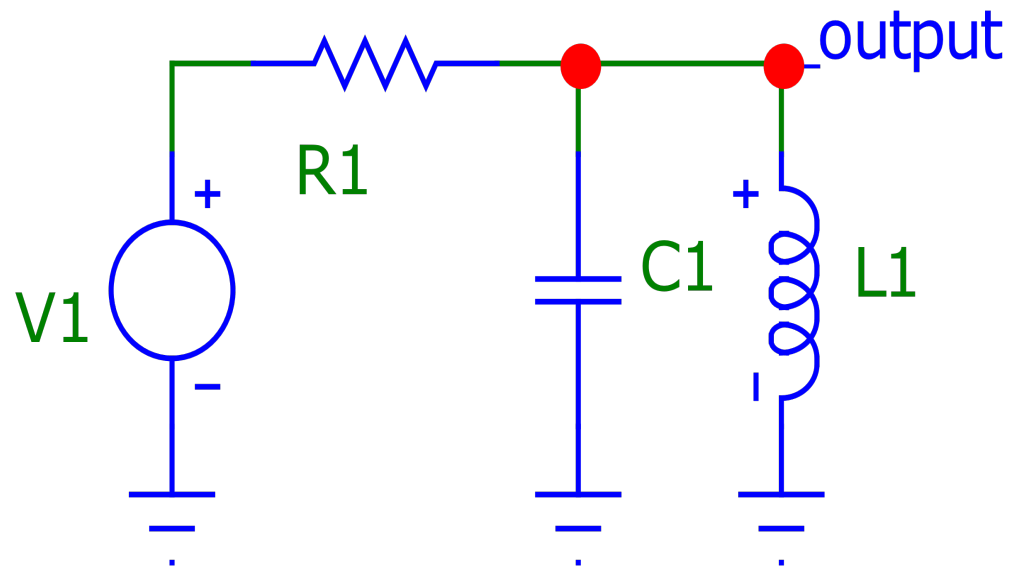

From: Mertens, Joost, and Joachim Denil. "ESS: EMF-Based Simulation Specification, A Domain-Specific Language For Model Validation Experiments." *2022 Annual Modeling and Simulation Conference (ANNSIM)*. IEEE, 2022.

# Face Validity: Distance to the Mental Model of Experts

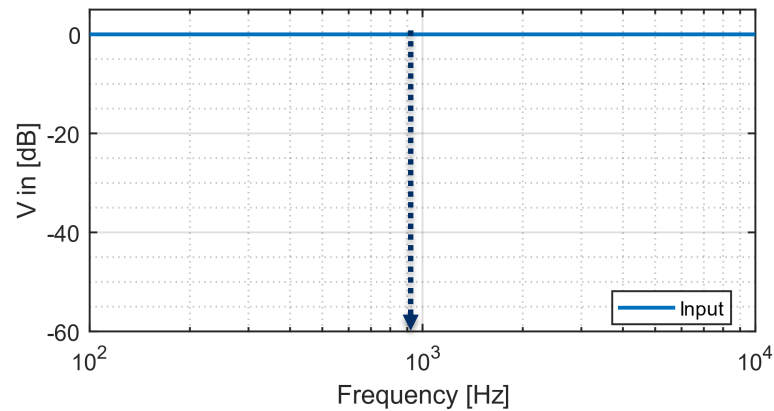
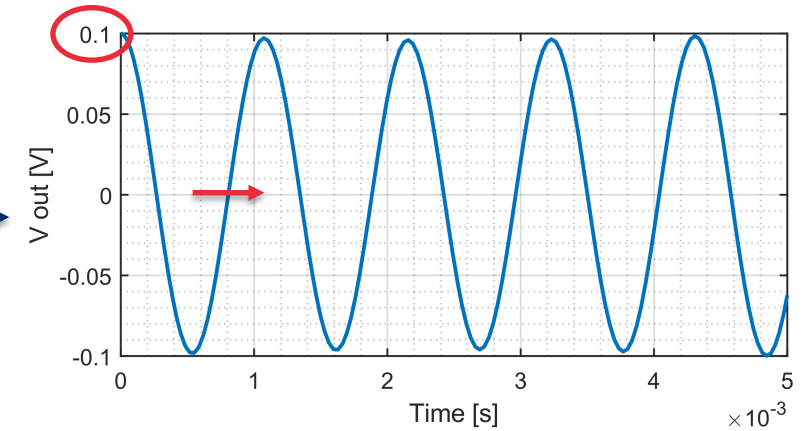
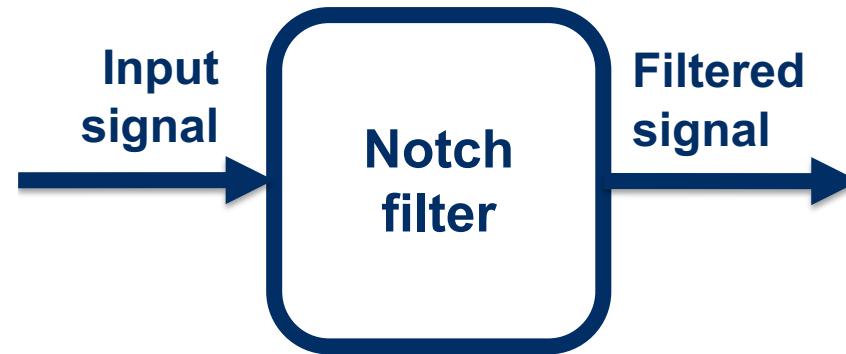
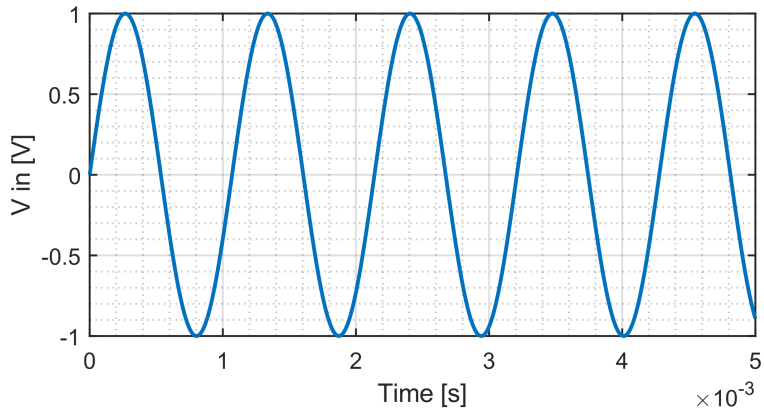

← After repeated evaluation at different frequencies, e.g., by performing AC analysis of circuit →

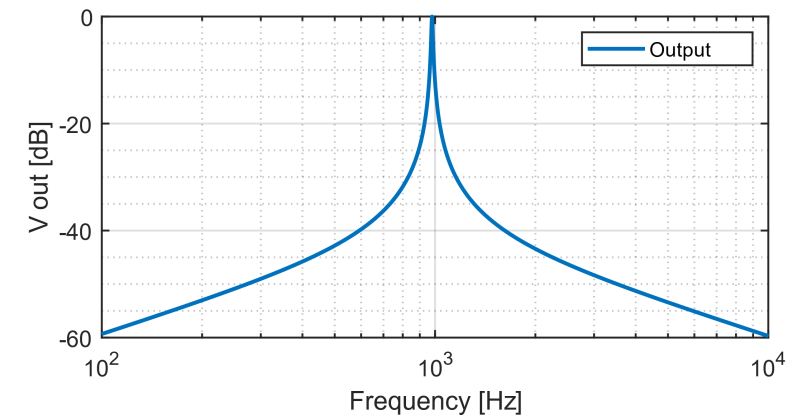

# How to perform this validation?

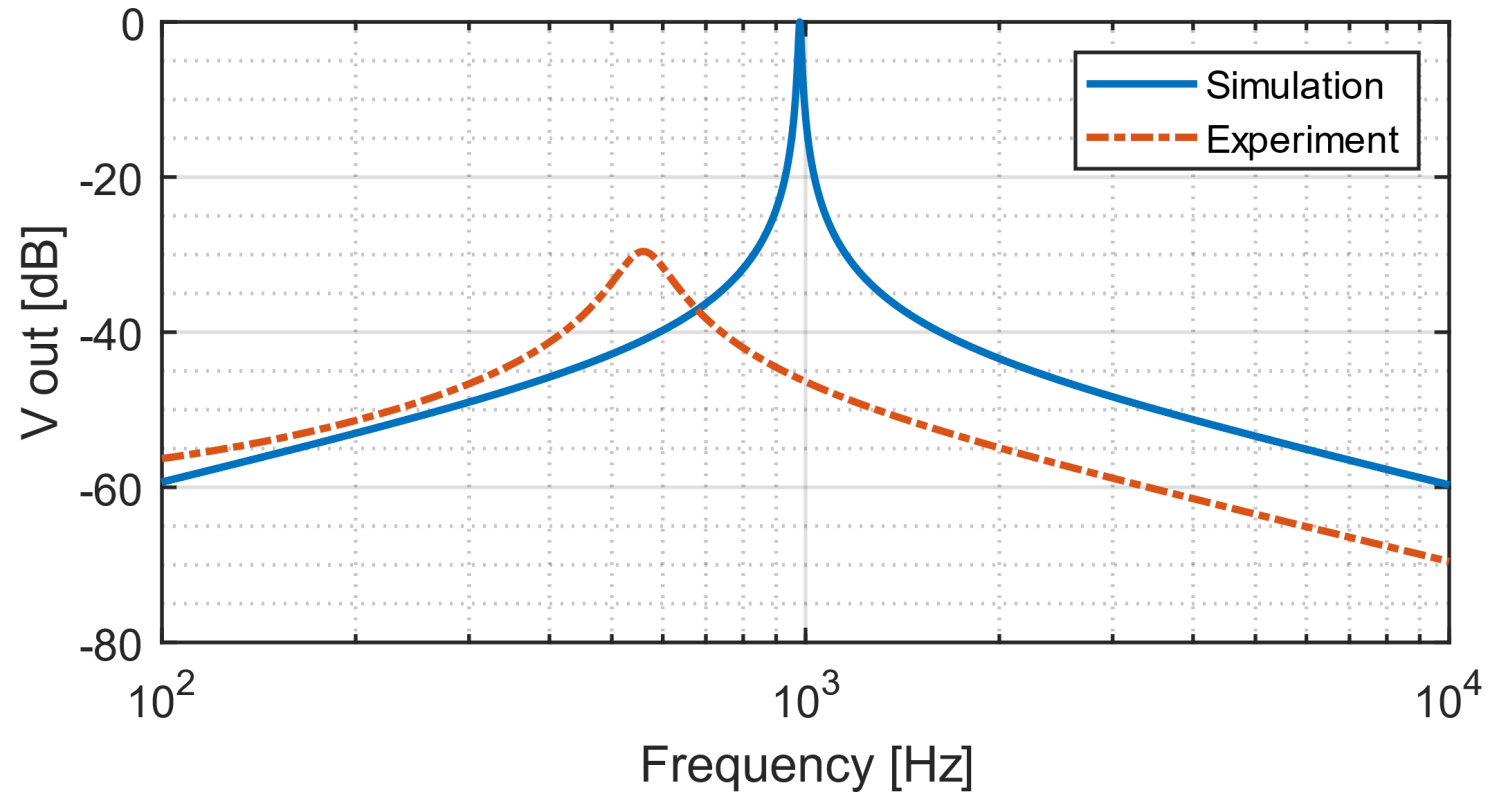

# How to perform this validation?

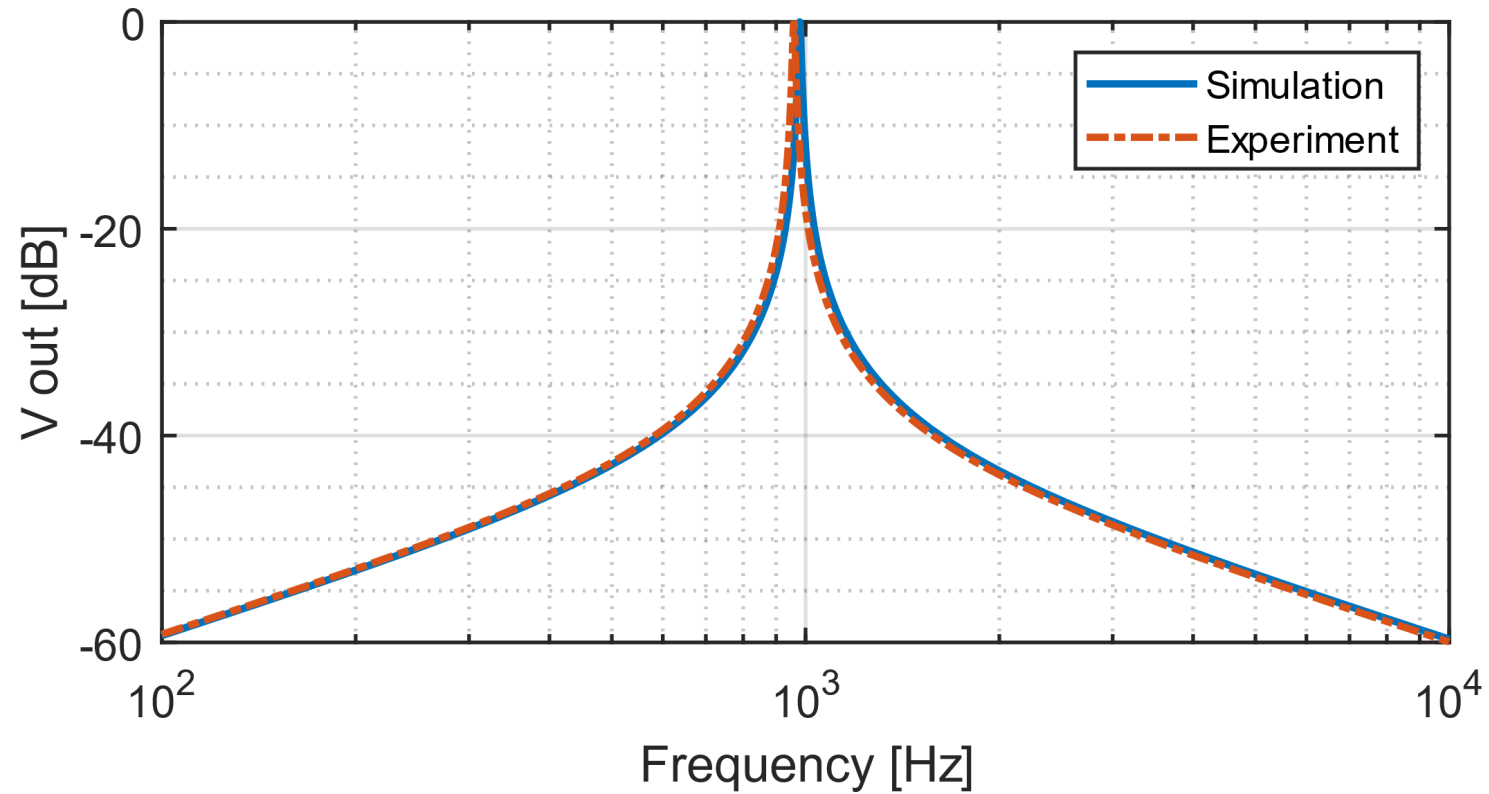

# Structural Validity: Distance between Structure of Model and Reality

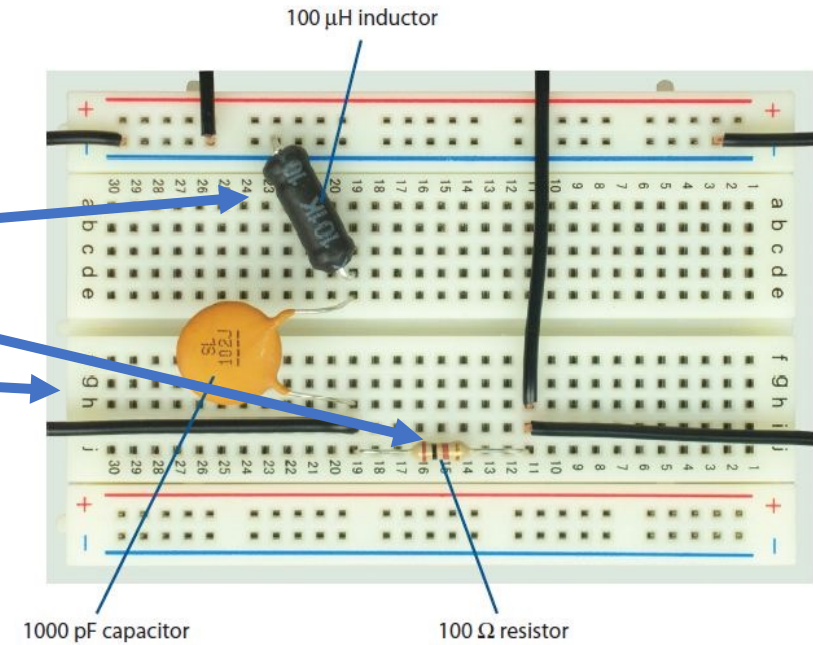
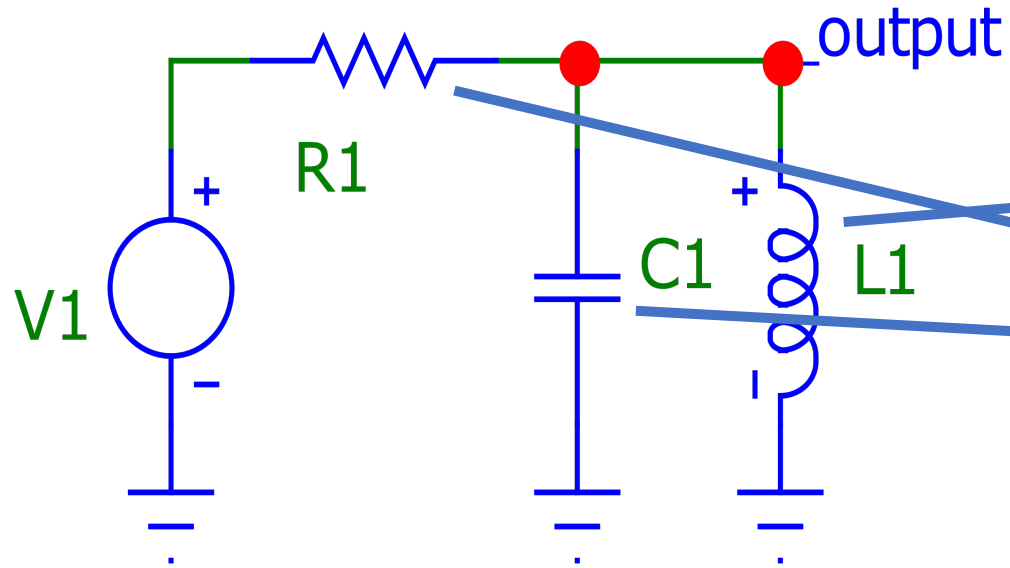

I am I generating the correct behaviour because of the right reasons?

# Other Filters Generate the Same Behaviour...

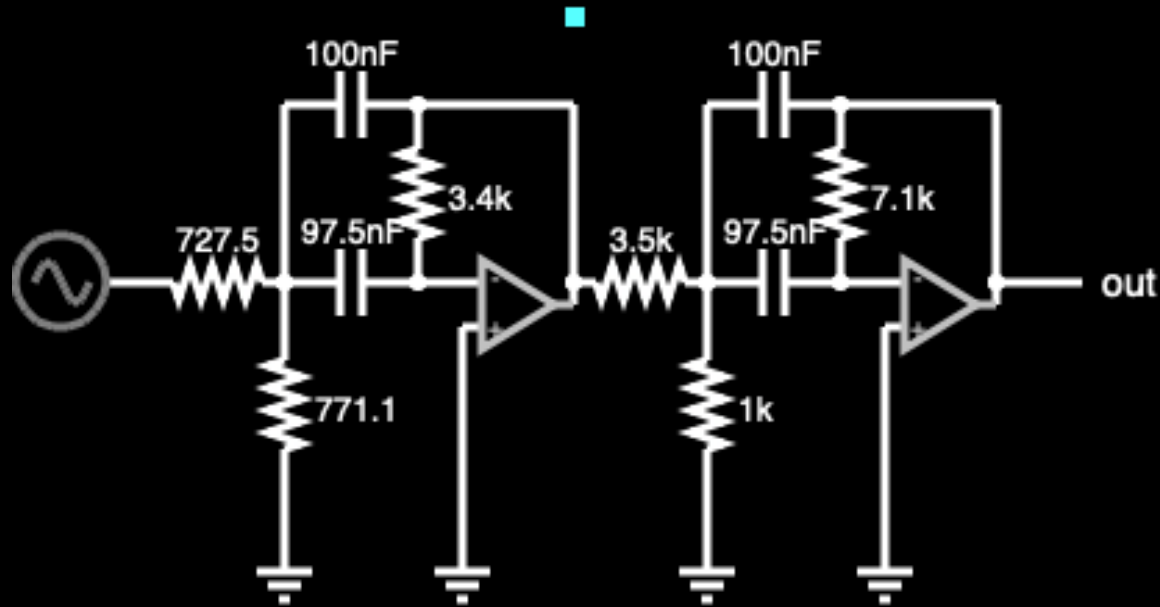

Butterworth filter (active)

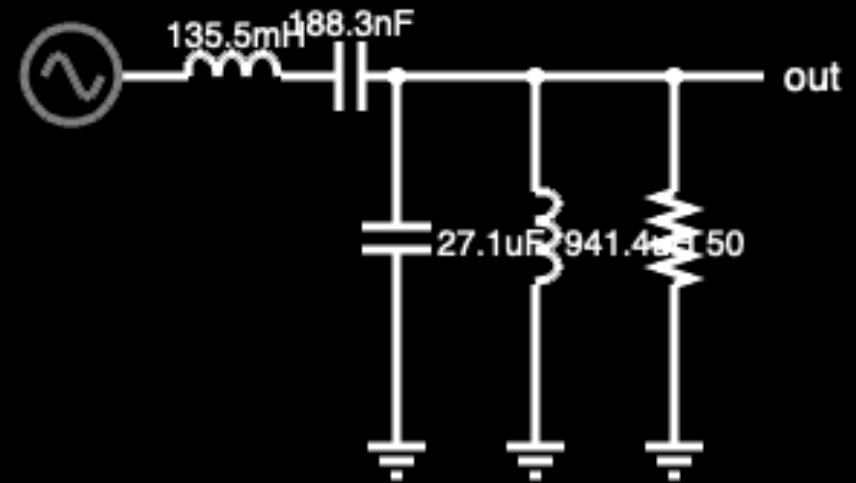

Butterworth filter 2nd order (passive)



# System's Dynamics

- Structure Verification Test
- Parameter Verification Test
- Extreme Condition Test
- Structure Boundary Adequacy
- Dimensional Consistency

TESTS FOR BUILDING CONFIDENCE IN  
SYSTEM DYNAMICS MODELS

Jay W. Forrester  
Peter M. Senge

June 8, 1979

System Dynamics Group  
Alfred P. Sloan School of Management  
Massachusetts Institute of Technology  
Cambridge, Massachusetts

# Statistical Validity: Statistical Distance between Model and Real-world Results

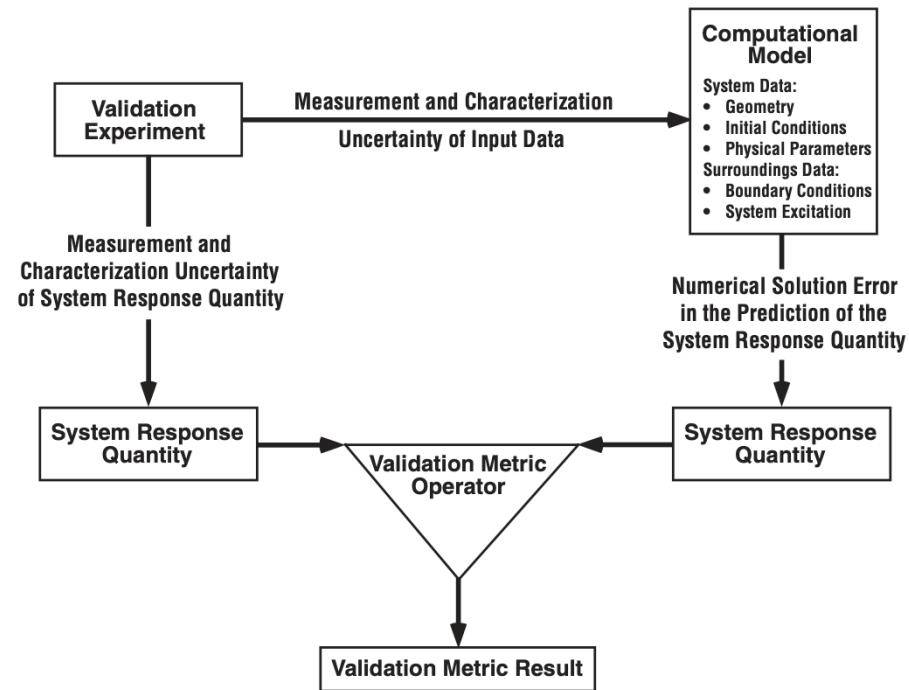

## Techniques:

- Bayesian
- Hypothesis testing
- Area metrics

From: Oberkampf and Roy, Verification and Validation in Scientific Computing, Cambridge

# Example: CDF Area Metric

- Cumulative Distribution Function (CDF) of *Property of Interest*
- Defined as area enclosed by CDF's
  - Of virtual and real experiment
  - Of two virtual or two real experiments
- Handles any type of uncertainty!
- Unit of area = unit of x-axis
  - Interpretation needs domain knowledge

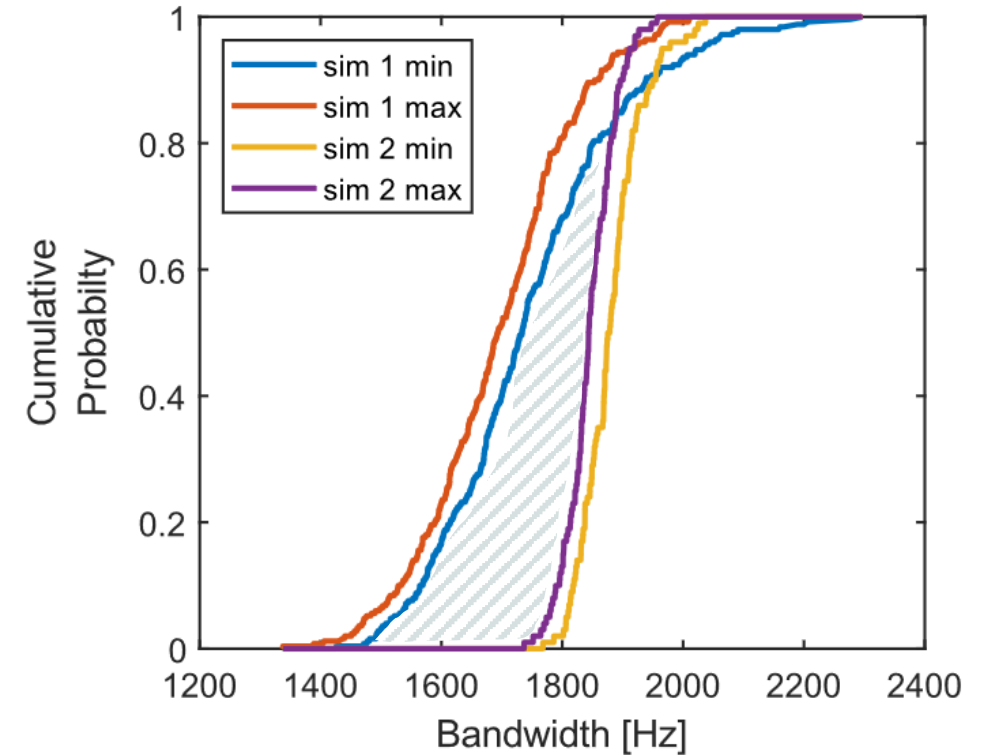

From: Mertens, Denil,

# Bridging the Design-Operation Continuum: Twinning Paradigm

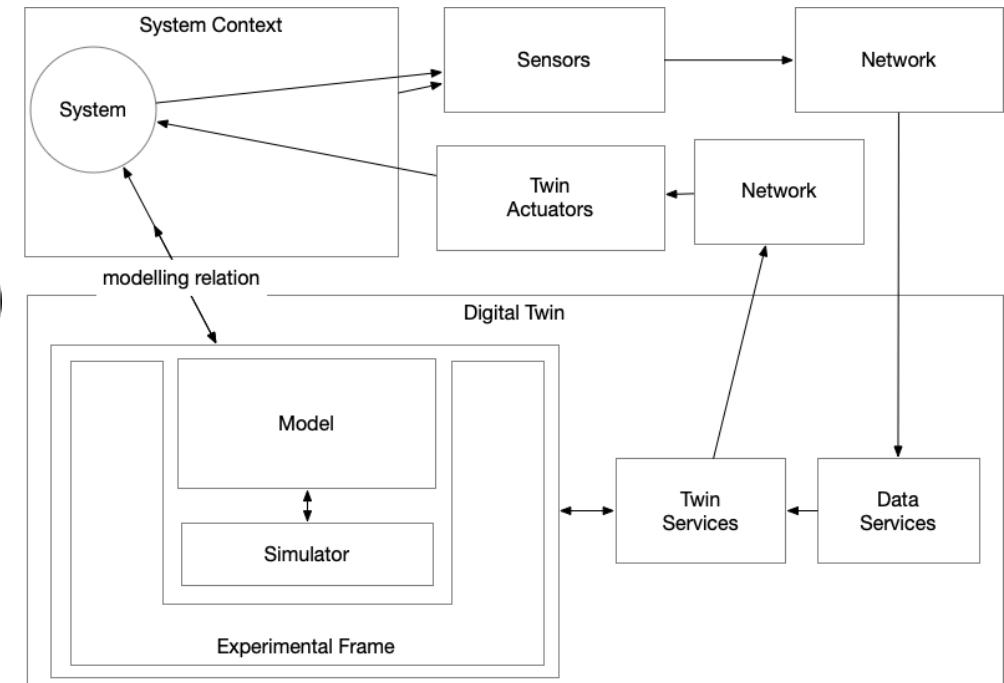
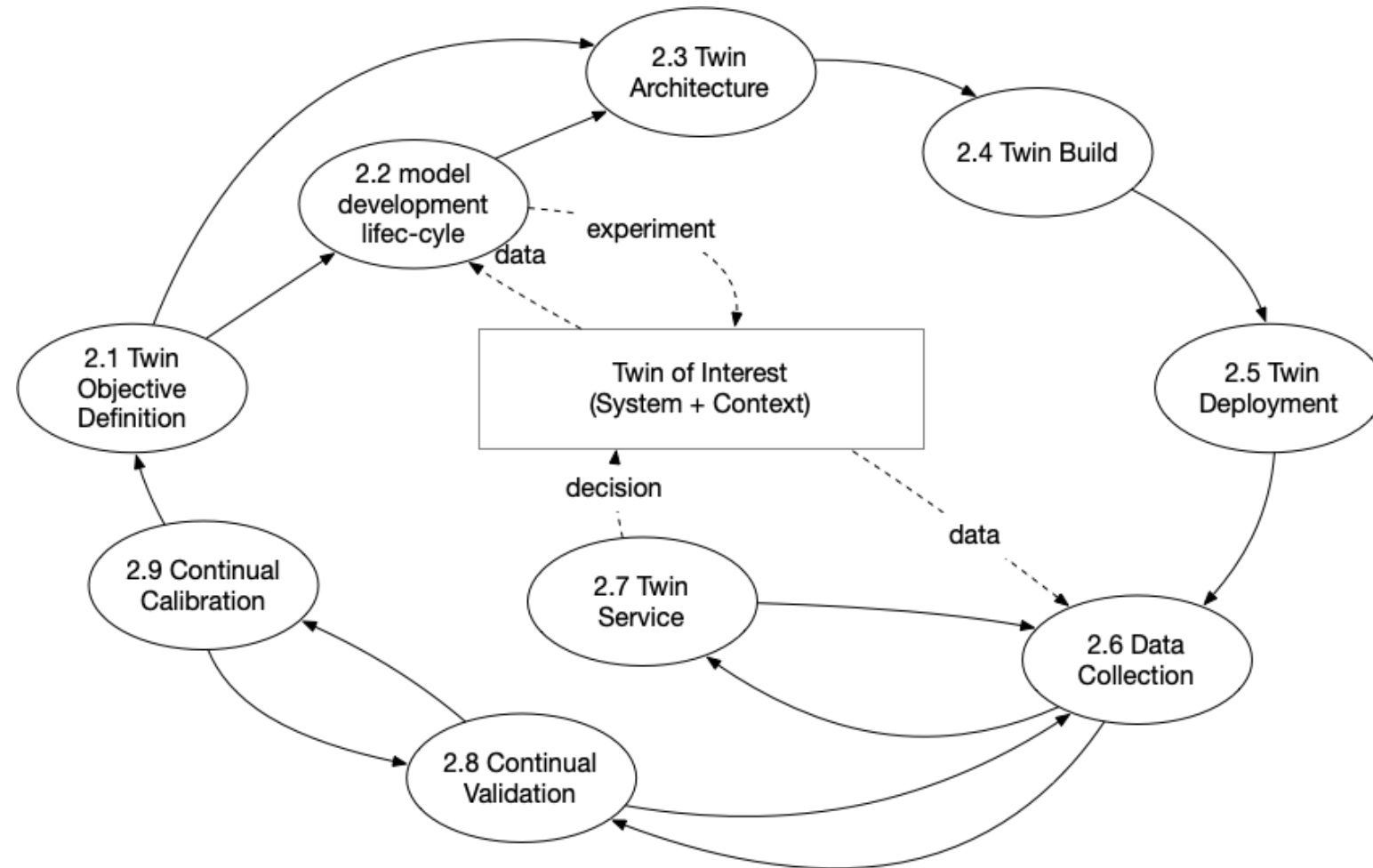

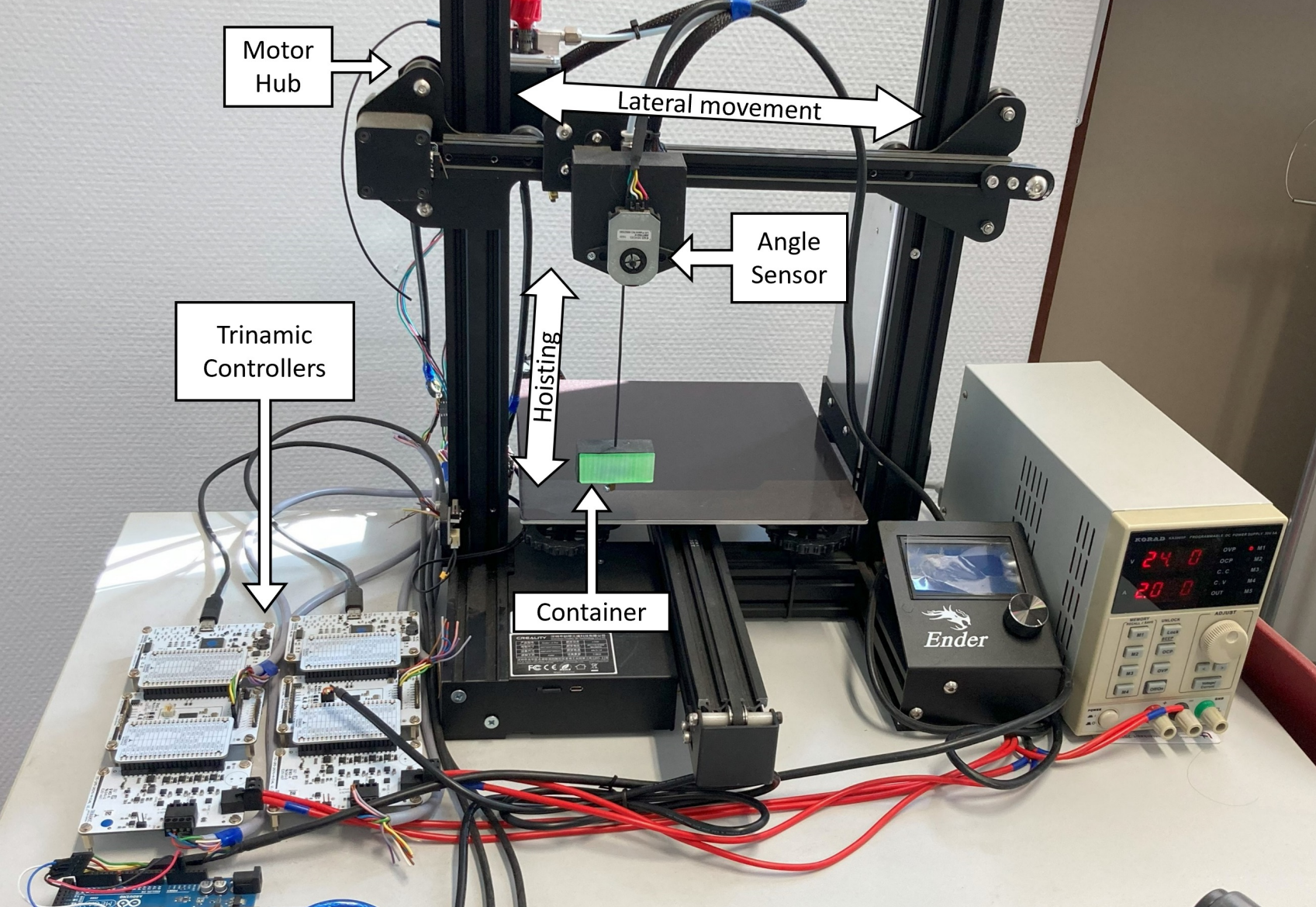



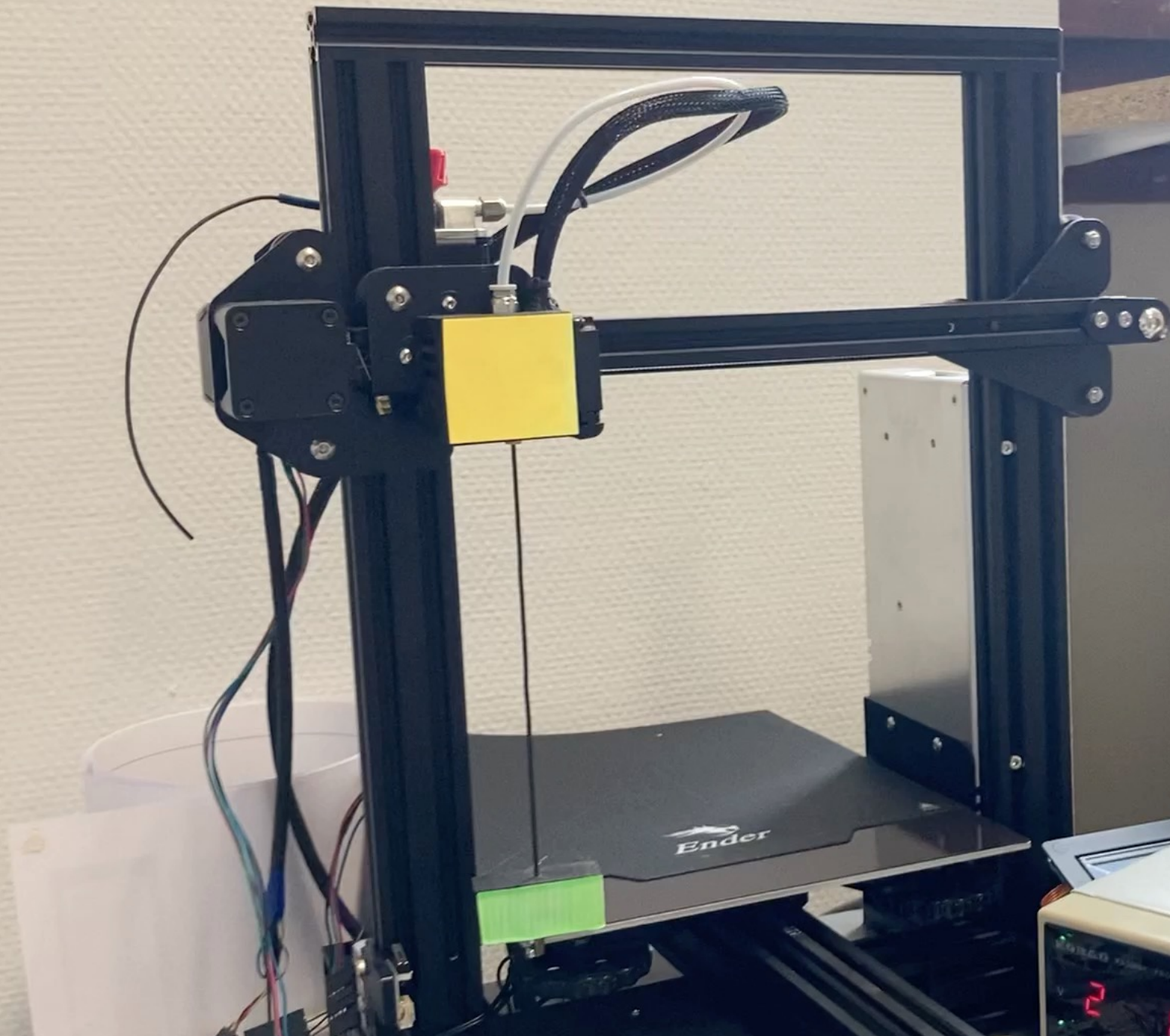

# Actual Twins Evolve...

- Wear and tear
- Replacements of components (e.g., motor replacement)

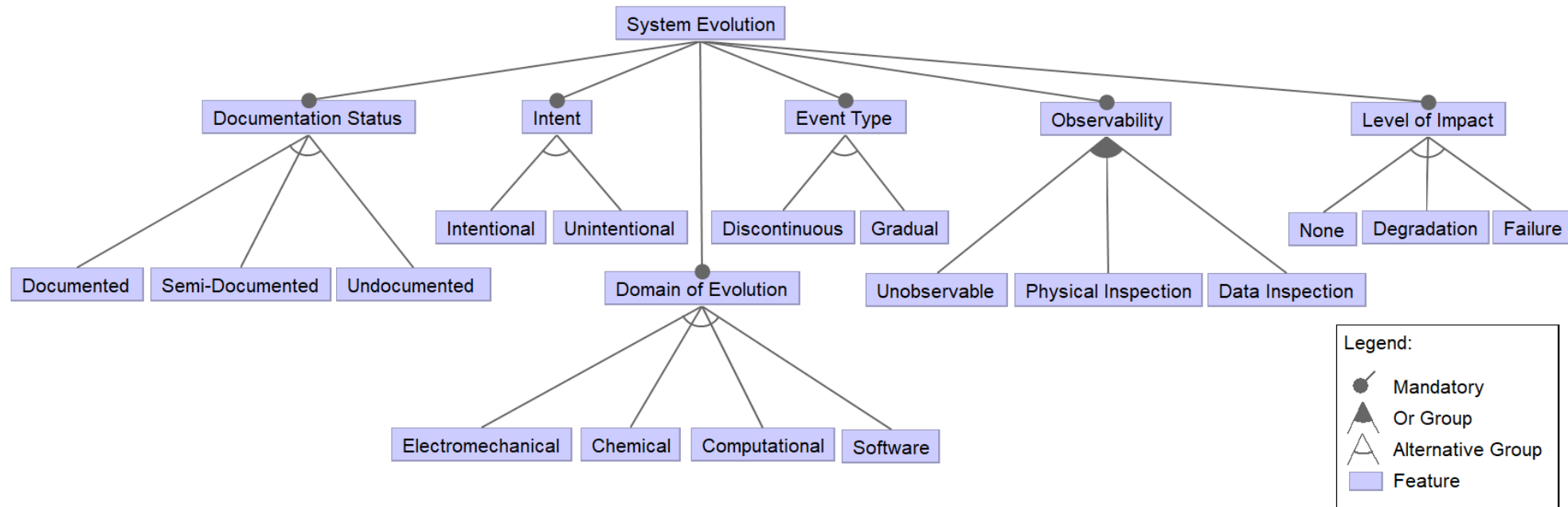



# How to Online Validate?

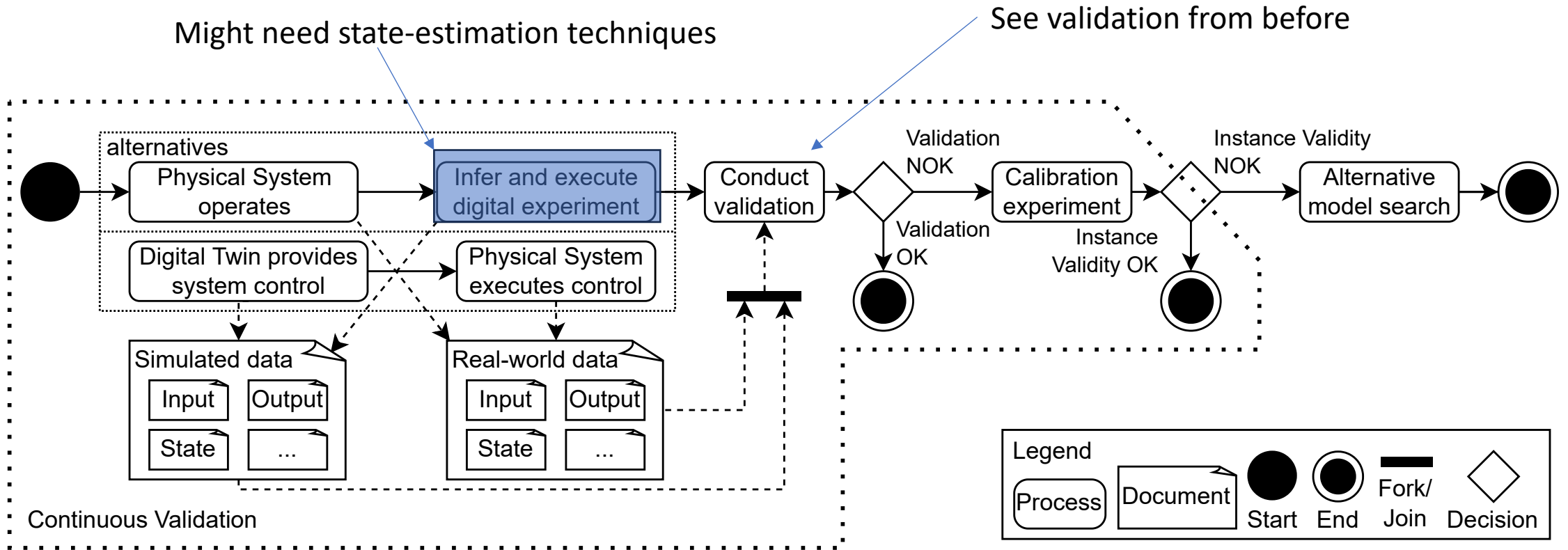

# Delimiting Experiments

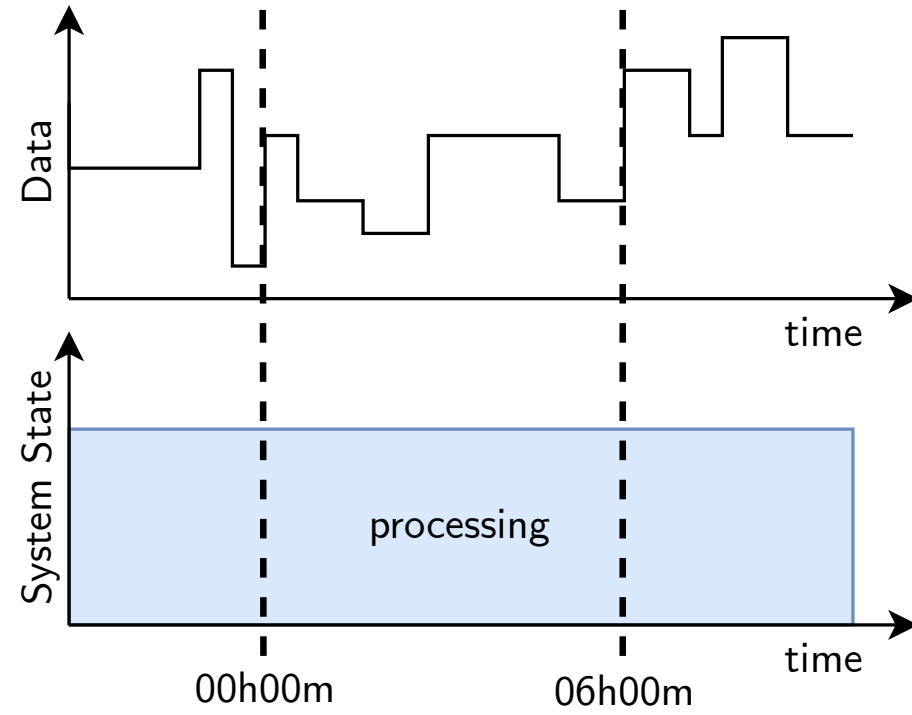
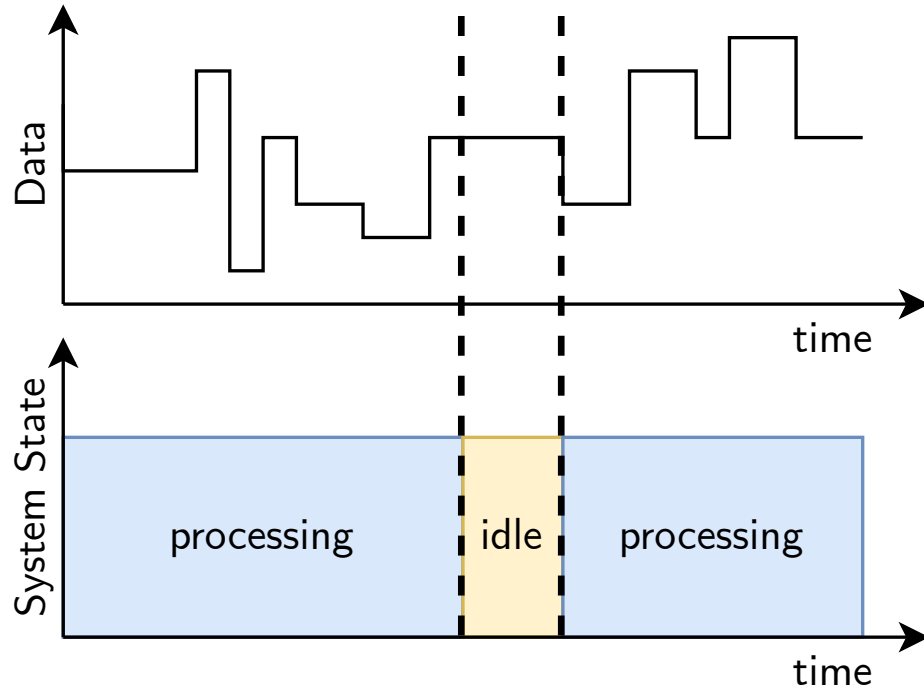

# Implementation

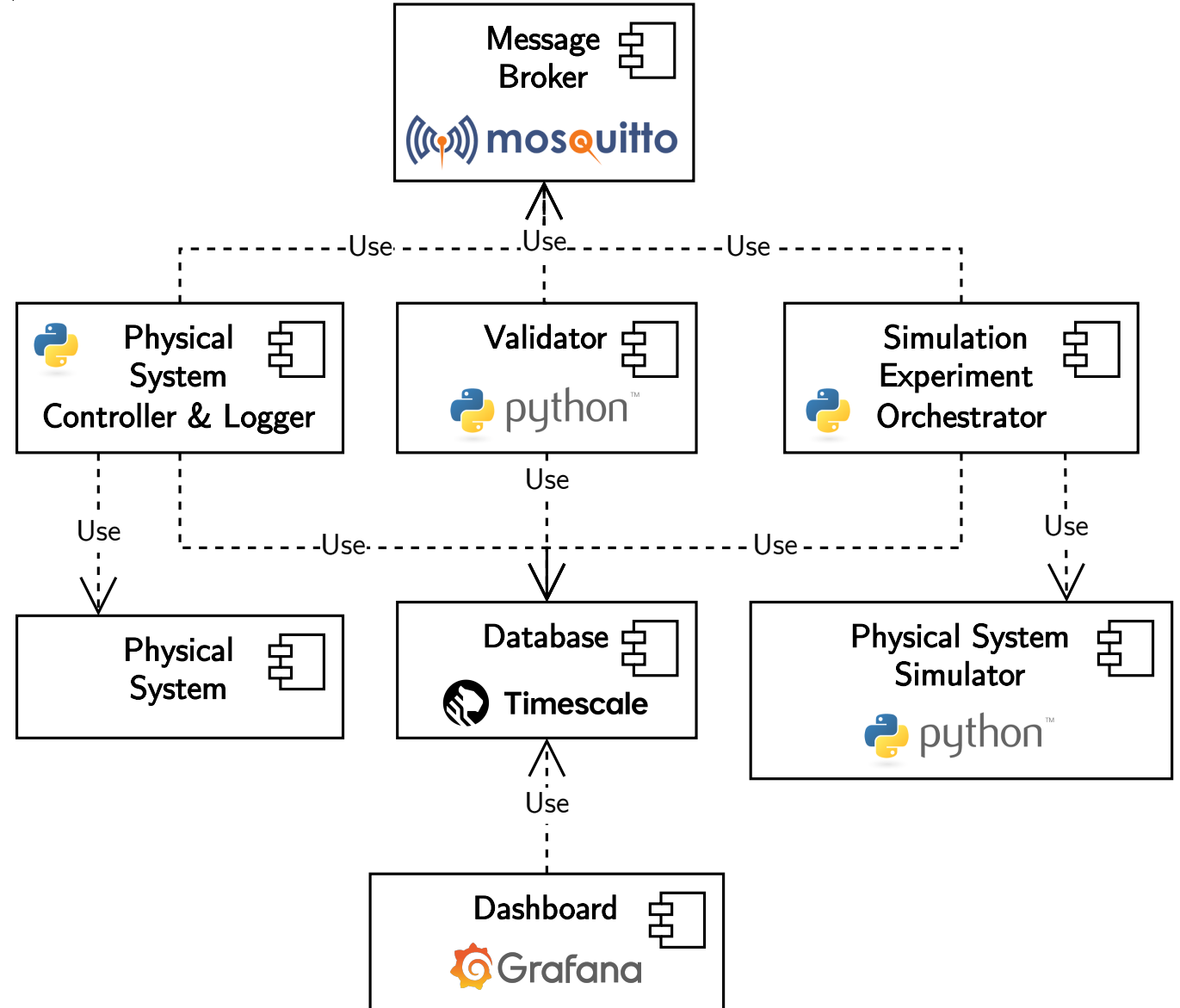

# Results

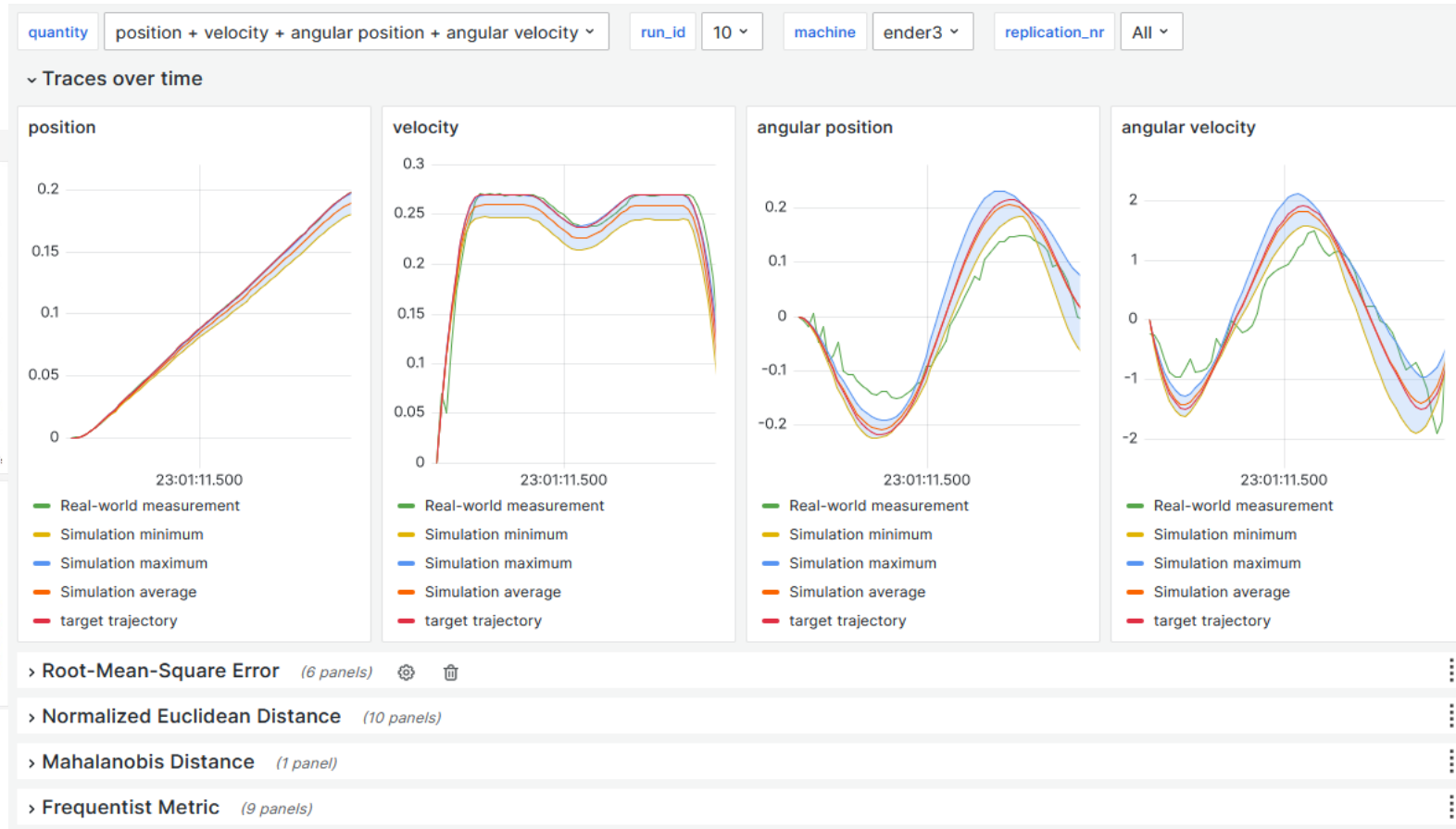

# Continual Validation: When? What? Which?

- When to do the validation run?
  - Every day? hour? minute? => Very case dependant
- What data do I use?
  - Wear and tear vs. changing of a component?
- Which validation metric?

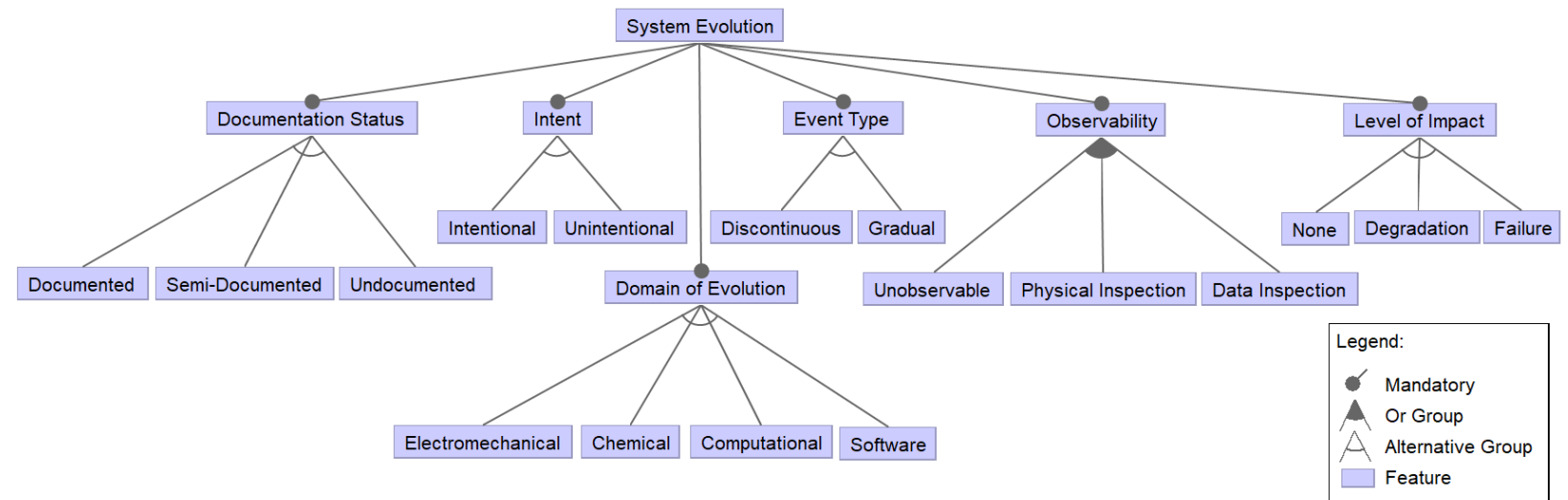

# Some remarks

- (Off-line) validation
  - manual validation
  - manual experiments
  - experimental design
- On-line validation
  - manual validation
  - real-world data
  - experiment delimitation
- Continual validation
  - automated validation
  - real-world data
  - experiment delimitation

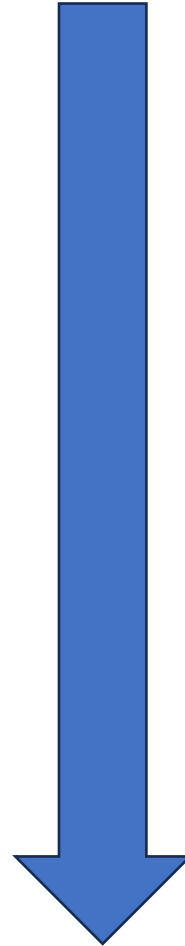

# Application: Virtual commissioning and Fleet management



Over the Air-updates:

- Systems in the fleet might have evolved
- Unknown environments

Testing should include these “undocumented variants”

Continual Validation discovers these variants!

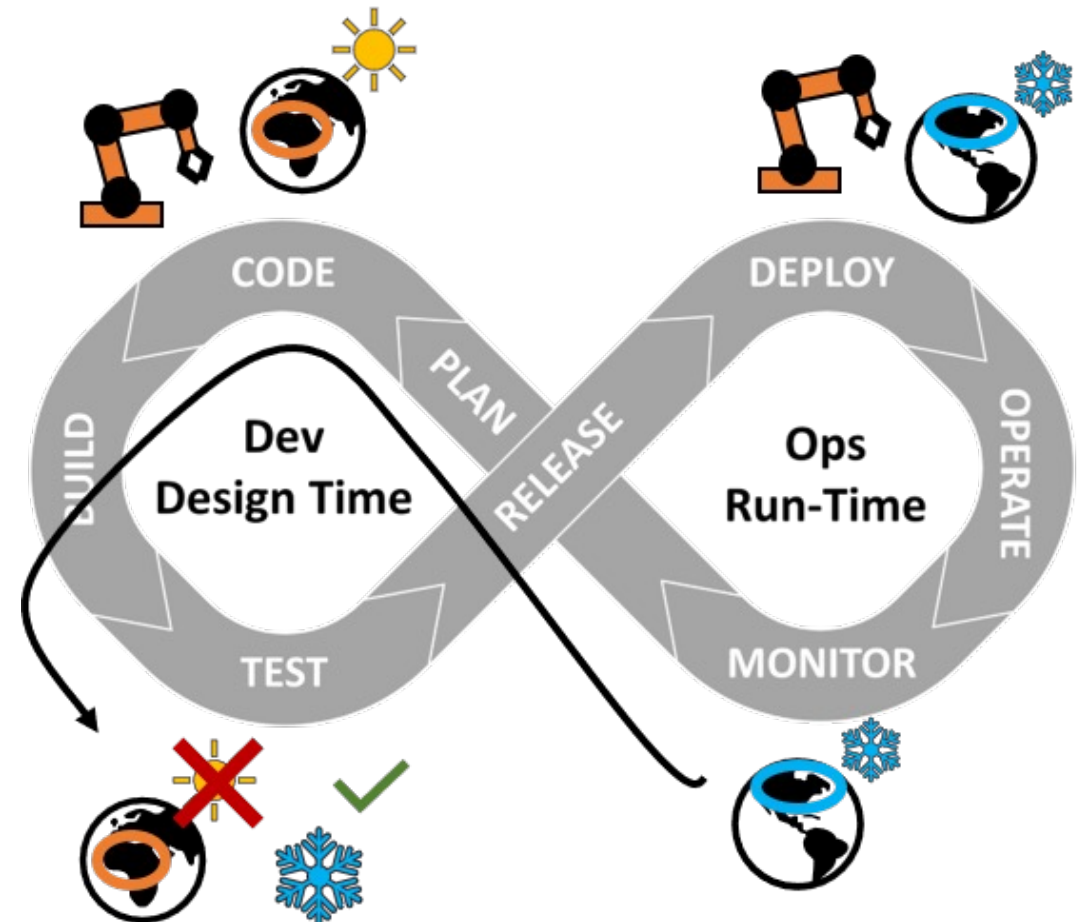



# Continual Experimentation

- We might not always have the correct data to validate all behaviours
- E.g., Crane is always doing a similar move
  - What if we could generate experiments at run-time that result in the same end-point, but provide much more information for validation?

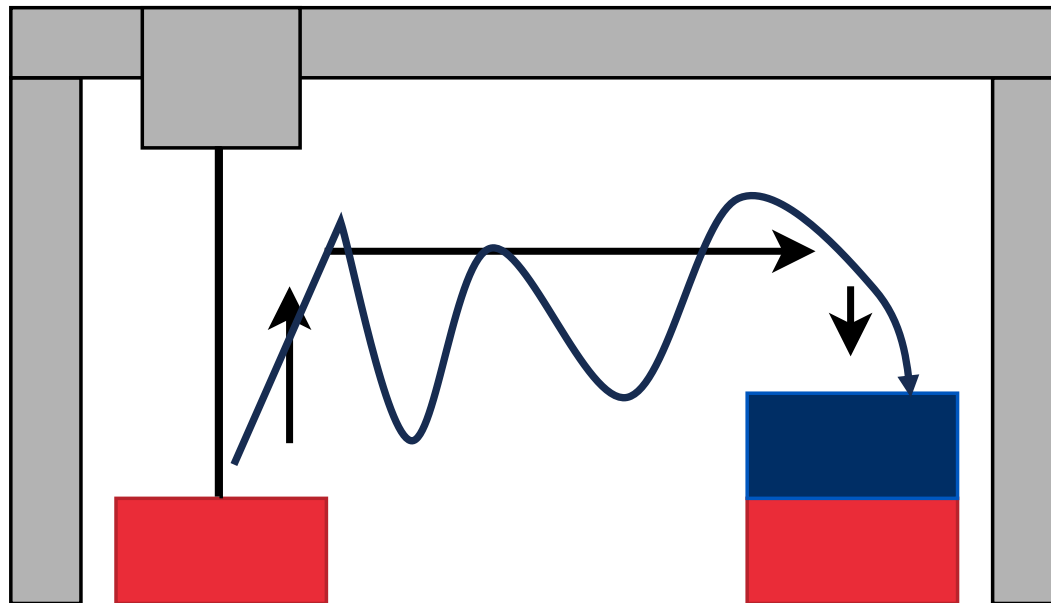

# Conclusion

- Digital twins require continual validation
- How to validate online?
  - Experiments are still the basis
  - But, experiments are not controlled
  - Need to be inferred (delimited/...)
- Continual validation
  - When to trigger?
  - What data to use?
  - Which metric to use?
- Not enough data?
  - Continual experimentation?